

DUPLICATE

**RECORDING REQUESTED BY AND
WHEN RECORDED RETURN TO:**

San Francisco Redevelopment Agency
770 Golden Gate Avenue
San Francisco, CA 94102
Attention: Development Services

This document is exempt from payment of a
recording fee pursuant to Government Code
Section 2738.

CONFORMED COPY of document recorded on,

as No. 04/05/2005.2005H932190 at Reel I 861, Image 564
This document has not been compared with the original
SAN FRANCISCO ASSESSOR RECORDER

Recorder's Stamp

DISPOSITION AND DEVELOPMENT AGREEMENT

**HUNTERS POINT SHIPYARD
PHASE 1**

by and between

**THE REDEVELOPMENT AGENCY
OF THE CITY AND COUNTY OF SAN FRANCISCO**

and

LENNAR/BVHP, LLC

Dated: December 2, 2003

TABLE OF CONTENTS

	<u>Page</u>
SECTION 1. DEFINITIONS AND INTERPRETATION	4
1.1 Definitions.....	4
1.2 Interpretation.....	13
SECTION 2. TERM OF AGREEMENT.....	14
2.1 Relationship Between Terms and Conditions Applicable to Infrastructure and Vertical Improvements.....	14
2.2 Infrastructure.....	14
2.3 Vertical Improvements.....	14
SECTION 3. LAND USES.....	15
SECTION 4. INFRASTRUCTURE OR HORIZONTAL DEVELOPMENT	15
4.1 Developer's Construction Obligations.....	15
4.2 Approval of Construction Plans.....	15
4.3 Conditions to Commencement of Construction.....	16
4.4 Issuance of Certificates of Completion.....	16
4.5 Failure to Issue Engineer's/Architect's Certificates or Certificates of Completion.....	17
SECTION 5. INSURANCE.....	17
5.1 Environmental Insurance	17
5.2 Other Insurance.....	17
SECTION 6. TERMS FOR CONVEYANCE OF PROJECT SITE TO DEVELOPER	17
6.1 General.....	17
6.2 Developer's Option.....	17
6.3 SLC Provisions	18
6.4 Escrow and Title	19
6.5 Agency Parcels.....	20
6.6 Conditions Precedent to Closing.....	21
6.7 Closing.....	25
6.8 Post-Closing Boundary Adjustments.....	26
6.9 Termination Notice	27
SECTION 7. PROPERTY CONDITION.....	27

TABLE OF CONTENTS

(continued)

	<u>Page</u>
7.1 As Is	27
7.2 Hazardous Substance Indemnification.....	28
7.3 Cooperation Regarding Environmental Matters	30
7.4 Risk of Loss	30
SECTION 8. COOPERATION AND ASSISTANCE	31
8.1 Interagency Cooperation Agreement	31
8.2 Issuance of Permits	31
8.3 Authorization	31
SECTION 9. INTERIM LEASE	32
SECTION 10. AGENCY ADMINISTRATION	32
SECTION 11. DEVELOPMENT OF AGENCY HOUSING PARCELS.....	33
SECTION 12. DISPUTE RESOLUTION.....	33
12.1 Arbitration/Mediation of Certain Disputes	33
12.2 Construction Disputes.....	33
12.3 Acknowledgment.....	34
12.4 Proceeding Pending Resolution of a Dispute.....	35
SECTION 13. DEFAULTS AND REMEDIES	35
13.1 General.....	35
13.2 Default by Developer or Guarantor(s).....	36
13.3 Agency's Remedies	38
13.4 Default by Agency	40
13.5 Developer's Remedies	40
13.6 Rights and Remedies Cumulative.....	41
13.7 No Implied Waiver	41
13.8 Limitation on Liability.....	41
13.9 Criteria For Specific Performance	41
SECTION 14. TRANSFERS OF OBLIGATIONS TO COMPLETE IMPROVEMENTS	42
14.1 The Agency's Right to Transfer	42
14.2 Developer's Right to Transfer	42

TABLE OF CONTENTS

(continued)

	<u>Page</u>
SECTION 15. TRANSFER OF LOTS	42
15.1 Minimum Purchase Price.....	42
15.2 Restricted Use Appraisal Report.....	42
15.3 Affiliate Lot	43
15.4 Community Builder Lot.....	45
15.5 New DDA	46
15.6 Criteria for Developer/Community Builder Ventures and Marketing Procedures.....	46
SECTION 16. RELOCATION ASSISTANCE.....	46
SECTION 17. INDEMNITY	47
17.1 General Indemnity	47
17.2 Common Law Remedies.....	47
17.3 Defense of Claims.....	47
SECTION 18. MORTGAGEE PROVISIONS.....	48
SECTION 19. RESTRICTIONS ON THE SITE AND DEVELOPMENT	48
19.1 General Restrictions.....	48
19.2 Restrictions Before Conveyance.....	48
19.3 Nondiscrimination.....	48
19.4 Effect, Duration and Enforcement of Covenants.....	49
19.5 Lead-Based Paint Prohibition	50
SECTION 20. MITIGATION MEASURES	50
SECTION 21. EQUAL OPPORTUNITY AND OTHER PROGRAMS	52
SECTION 22. MISCELLANEOUS	53
22.1 Incorporation of Attachments and Recitals.....	53
22.2 Notices	53
22.3 Time for Performance	54
22.4 Non-Merger in Deed	55
22.5 Unavoidable Delays	55
22.6 Attorneys' Fees	55
22.7 Successors and Assigns/No Third-Party Beneficiary	56

TABLE OF CONTENTS

(continued)

	<u>Page</u>
22.8 Estoppel Certificates	56
22.9 Brokers	56
22.10 Governing Law	56
22.11 Authority and Enforceability	56
22.12 Further Assurances.....	57
22.13 Eminent Domain	57
22.14 Severability	57
22.15 Entire Agreement; Supersedure	57
22.16 No Party Drafter.....	57
22.17 Approvals and Consents	57
22.18 Represented By Counsel.....	58
22.19 Recordation	58
22.20 Counterparts.....	58
22.21 Modification.....	58

DISPOSITION AND DEVELOPMENT AGREEMENT

HUNTERS POINT SHIPYARD

PHASE 1

THIS DISPOSITION AND DEVELOPMENT AGREEMENT (this "Agreement"), dated as of December 2, 2003 (the "Effective Date") is entered into by and between the REDEVELOPMENT AGENCY OF THE CITY AND COUNTY OF SAN FRANCISCO, a public body, corporate and politic, exercising its functions and powers and organized and existing under the Community Redevelopment Law of the State of California (together with any successor public agency designated by or pursuant to law, the "Agency"), and LENNAR/BVHP, LLC, a California limited liability company doing business as Lennar/BVHP Partners ("Developer"). Agency and Developer are each a "Party" and collectively are the "Parties". Developer's obligations under this Agreement have been guaranteed by Lennar Corporation, a Delaware corporation, and LNR Property Corporation, a Delaware corporation, (collectively the "Guarantor") under that certain Guaranty Agreement (the "Guaranty") in the form attached as Attachment 8, which has been executed and delivered by Guarantor and the Agency concurrent with Developer's and the Agency's execution of this Agreement.

RECITALS

A. In 1974, the United States of America, acting through the Department of the Navy (the "Navy"), closed the Hunters Point Naval Shipyard (the "Shipyard"), located in the City and County of San Francisco (the "City"), and leased it to a commercial ship repair company. In 1991, the Shipyard was selected for transfer under the Defense Base Closure and Realignment Act of 1990, Part A of Title XXIX of Public Law 101-510, 10 U.S.C. § 2687, as amended ("BRAC").

B. In accordance with the Community Redevelopment Law of California (Health & Safety Code §§ 33000 *et seq.*), the City, acting through its Board of Supervisors, approved a Redevelopment Plan for the Shipyard by Ordinance No. 285-97 adopted on July 14, 1997 (the "Redevelopment Plan"). In cooperation with the City, the Agency is in the process of implementing the Redevelopment Plan. The Redevelopment Plan was recorded on November 21, 2003, as Document No. H595996 in the official records of the City.

C. The Redevelopment Plan provides for the redevelopment, rehabilitation and revitalization of the area shown on the Land Use Plan attached to the Redevelopment Plan. The Amended Design for Development for Vertical Improvements will provide additional guidelines for the redevelopment of Phase 1.

D. The Navy and the Agency have negotiated a comprehensive agreement governing the terms and conditions for the transfer of the Shipyard from the Navy to the Agency (the "Conveyance Agreement"). Pursuant to the Conveyance Agreement, the Shipyard is divided into six (6) parcels designated A through F. The Navy will convey the Shipyard to the Agency over time in phases, as the Navy completes environmental remediation and is able to issue a Finding of Suitability to Transfer ("FOST") for specified parcels or portions thereof. The

portion of the Shipyard subject to this DDA ("Phase 1") comprises portions of Parcels A and B, as designated by the Navy, including the hilltop area of Parcel A ("Parcel A-1") and the south side of the hill and certain flat portions of Parcel B ("Parcel B-1"). Phase 1 is more particularly described in Attachment 1 and is shown on the map attached as Attachment 2, which also identifies Parcels A-1 and B-1 (identified respectively as Parcel A' and B').

E. While the Agency and Developer remain committed to developing the entire Shipyard, this Agreement covers only Phase 1. The focus on Phase 1 responds to community concerns over potential health and environmental impacts associated with developing environmentally clean portions of the Shipyard while remediation efforts on adjacent parcels may be ongoing. The boundaries of Phase 1 reflect reasonable assumptions about the timing and nature of the Navy's remediation efforts, in that Parcels A-1 and B-1 are expected to be cleaned before the other parcels and are located furthest away from scheduled cleanup activities on the other parcels. Decisions regarding future development outside of Phase 1 may be made more effectively when additional information about the Navy's remediation efforts in those areas becomes available. The Agency and Developer remain committed to working with the City's Board of Supervisors to see that Proposition P is carried out. Proposition P, approved by the voters on November 7, 2000, and adopted by the Board of Supervisors as City policy on July 30, 2001, calls upon the Navy to remediate the Shipyard to the highest levels practical to assure the flexible reuse of the Shipyard.

F. Phase 1 itself will also be developed incrementally; in particular, Parcel A-1 will very likely be conveyed prior to Parcel B-1. The phasing plan, again, reflects sensitivity to the timing and nature of the Navy's remediation efforts.

G. On April 22, 1998, the Agency issued a Request for Qualifications to a number of development teams for the conveyance, management and redevelopment of the Shipyard. On March 30, 1999, the Agency Commission determined that Developer was the most qualified of the developer teams that had submitted responses. On June 1, 1999, the Agency and Developer entered into an Exclusive Negotiations Agreement ("ENA") setting forth the terms and conditions under which the parties would seek to negotiate transaction documents for the conveyance, management and redevelopment of the Shipyard.

H. The ENA includes a schedule of performance setting forth a number of negotiating milestones. The first key milestone, Developer's presentation of a Preliminary Development Concept ("PDC") for the Shipyard, was achieved on July 20, 2000 with the Agency Commission's endorsement of the PDC, based on recommendations from the Mayor's Hunters Point Shipyard Citizen Advisory Committee (the "CAC"), after public review. On January 13, 2003, a Conceptual Framework for Phase 1 Development of the Hunters Point Shipyard (the "Conceptual Framework") was issued. Following review by the CAC and other stakeholders, the Agency approved the Conceptual Framework on July 22, 2003. This Agreement follows from and reflects the approved Conceptual Framework. Concurrent with this Agreement, the Agency will grant to Developer an extension of the term of the ENA for Phase 2 of the Shipyard (the "Phase 2 ENA").

I. The Phase 1 development plan is based on the Redevelopment Plan for the Shipyard and the Conceptual Framework. Phase 1 includes approximately 1,600 residential units, at least 32%

of which will be affordable to low- and moderate-income residents, a mix of approximately 30% rental units and 70% for-sale units, commercial space, community development facilities and active and passive open space. In order to achieve the development plan for Phase 1, significant public infrastructure improvements need to be made. The Infrastructure Plan attached as Attachment 9 to this Agreement outlines the infrastructure improvements in detail, including demolishing existing structures, grading, constructing a new roadway network and pedestrian improvements, constructing new utility systems and creating public open space.

J. The Financing and Revenue Sharing Plan attached as Attachment 25 to this Agreement outlines the transaction structure for development of Phase 1. This structure is based on a “horizontal” land development model. Under this model, land is the asset that is being improved and sold, not buildings. Because the Shipyard is basically a large parcel of raw land, the transaction structure is designed to transform this raw land into “finished lots” (*i.e.*, subdivided and improved with streets, sidewalks, parks, open space and utilities). Once improved and subdivided into marketable lots, and after streets, parks, open space, utilities rights of way and other public property rights are dedicated or otherwise conveyed to the Agency or the City, parcels then will be either (1) sold at fair market value to private parties for the “vertical” development of affordable and market rate housing and commercial facilities, as set forth in this Agreement and the Redevelopment Plan or (2) retained by the Agency for the “vertical” development of affordable housing and for community economic development, either by the Agency or a third-party. As set forth in this Agreement, Developer is responsible for necessary demolition, design and construction of the Horizontal Improvements. Developer is also responsible for managing any Shipyard property conveyed by the Navy to the Agency under the Interim Lease attached as Attachment 29 to this Agreement.

K. Under the Financing and Revenue Sharing Plan attached as Attachment 25, the proceeds of the sales of “finished lots” to private parties are allocated first to repay debt service and then to pay both the Agency and Developer market-based returns on their respective financial contributions (the Agency’s land and Developer’s predevelopment dollars). Any excess proceeds are divided between the Agency and Developer in equal shares. The Agency will use 100% of its share of these proceeds for community benefits related to the Shipyard, as outlined in the Community Ownership, Financing and Benefits attached as Attachment 23 to this Agreement.

L. As further set forth in the Financing and Revenue Sharing Plan, it is anticipated that a significant portion of the required Infrastructure will be directly financed from the sales of finished lots within Phase 1. In order to pay for costs attributable to the initial public improvements, such as streets, parks and utilities, as well as to reimburse Developer for certain Public Facility Predevelopment Costs and Public Facility Pre-Agreement Costs (both as defined in Attachment 25), the Agency intends to issue Mello-Roos Bonds (as defined in Attachment 25).

M. As an alternative to the Financing and Revenue Sharing Plan attached as Attachment 25, Developer has a limited option to purchase the Agency’s interest for the price and on the terms and conditions set forth in Attachment 26, which, among other provisions, gives the Agency an up-front lump sum payment and the right to participate in revenues from Vertical Development,

and requires Developer to continue to afford Community Builders the rights set forth in Section 15.4.

N. The development proposed pursuant to this Agreement and the fulfillment generally of this Agreement are (i) in accordance with the public purposes and provisions of applicable federal, state and local laws and requirements and (ii) consistent with, in furtherance of, and necessary to, the effectuation of the Redevelopment Plan.

SECTION 1. DEFINITIONS AND INTERPRETATION

1.1 Definitions.

The following capitalized terms have the meanings set forth in this Section, wherever used in this Agreement.

Abandon(s) or Abandonment means the period during which no Work is performed on the Project Site and Agency Parcels.

Affiliate means a Person in which Developer or a Vertical Developer, as the case may be, directly or indirectly owns and/or controls (a) twenty five percent (25%) or more (or if such Person is not publicly traded, fifty percent (50%) or more) of each class of equity interests (including rights to acquire such interests), or (b) twenty-five percent (25%) or more (or if such Person is not publicly traded, fifty percent (50%) or more) of each class of interests that have a right to nominate, vote for or otherwise select the members of the board or other governing body that directs or causes the direction of substantially all of the management and policies of that Person. An Affiliate must meet the same creditworthiness and development experience qualifications as a Qualified Buyer.

Affiliate Lot(s) means the parcels over which Affiliates of Developer have certain rights of refusal in accordance with Section 15.3.

Affiliate Purchase and Sale Agreement has the meaning set forth in Section 15.3(b).

Affordable Housing Program means the plan for affordable housing set forth in Attachment 22.

Affordable Housing Units means, collectively, the Vertical Developer Inclusionary Units and the Agency Affordable Housing Units.

Agency has the meaning set forth in the preamble to this Agreement.

Agency Affordable Housing Units means the Residential Units constructed on Agency Housing Parcels.

Agency Costs means the reasonable costs and expenses actually paid by the Agency consistent with the purposes of this Agreement, including reasonable costs and fees of third-party professionals necessary for the Agency to perform its duties hereunder and costs paid

by the Agency to City agencies (excluding costs paid directly by Developer to City agencies). Agency Costs do not include (a) general and administrative costs or overhead of the Agency except for costs directly attributable to staff time allocable to implementation of the development contemplated under this Agreement, (b) fees or costs incurred in connection with an amendment of the Redevelopment Plan not consented to by Developer in accordance with this Agreement and (c) litigation costs otherwise potentially recoverable under Section 22.7.

Agency Housing Parcels means the parcels to be retained by the Agency and designated as the “Affordable Housing Parcels” on the map attached as Attachment 2.

Agency Parcels means, collectively, the Agency Housing Parcels, Community Facility Parcels and Open Space, all of which are shown on the map attached as Attachment 2.

Agreement has the meaning set forth in the preamble to this Agreement, and includes all Attachments to the Agreement and all amendments made in accordance with Section 22.22.

Amended Design for Development for Vertical Improvements means the document governing density, height, bulk and other specified matters for Vertical Development and for the Agency Housing Parcels referenced in Section 6.6(c)(8)(h).

Appraiser means a member of the Appraisal Institute with at least ten (10) years of experience in appraising the kind of real property in the City that he or she is called upon to appraise under this Agreement.

Approved Budget has the meaning set forth in Attachment 25.

Approved Expense has the meaning set forth in Attachment 25.

Arbiter has the meaning set forth in Section 12.2.2(d).

Authorization has the meaning set forth in Section 8.3(a).

Bayview Hunters Point Area or BVHP Area means that portion of the City and County of San Francisco located in zip code areas 94124, 94134 and 94107 as of the Effective Date, which comprise the neighborhoods most affected by closure of the Shipyard. Unless otherwise expressly indicated, references to Bayview, Hunters Point, the community, neighborhoods and variants of those terms mean the BVHP Area.

BRAC has the meaning set forth in Recital A.

Broker means a licensed real estate broker with at least ten (10) years of experience in representing sellers of the kind of real property in the City that he or she is called upon to list under this Agreement.

Building Permit means a building or site permit issued by the City’s Central Permit Bureau of the Department of Building Inspection, which will allow Developer to Commence Construction of Horizontal Improvements pursuant to this Agreement.

Business Day means a day other than Saturday, Sunday or a bank, City or Agency holiday.

Certificate of Completion has the meaning set forth in Section 4.4(a).

Citizen's Advisory Committee or **CAC** has the meaning set forth in Recital H.

City has the meaning set forth in Recital A.

Close of Escrow or **Closing** means the recordation of the grant deed evidencing the conveyance of all or a portion of the Project Site. There will be a separate Close of Escrow for each of Parcel A-1 and for Parcel B-1.

Commence Construction means the commencement of substantial physical construction of the Horizontal Improvements as part of a sustained and continuous construction plan.

Community Benefits means new jobs, construction business opportunities, affordable housing and other benefits of developing the Shipyard in accordance with this Agreement, to be funded by the Agency's share of land proceeds.

Community Builder means a Qualified Community Builder as set forth in the Additional Business, Employment, Construction Assistance/Opportunities and Community Benefits Program attached as Exhibit B to Attachment 24.

Community Builder Lots means thirty percent (30%) of the Affiliate Lots, to be calculated by designating three (3) of every ten (10) Lots of each housing type as a Community Builder Lot, e.g., three (3) of every ten (10) Lots on which town homes are to be developed will be Community Builder Lots, as will three (3) of every ten (10) Lots on which apartment houses are to be developed. In the event there are less than ten (10) Lots in any given housing type, then the thirty percent (30%) calculation shall be rounded up to the nearest whole Lot, e.g., if there are only nine (9) Lots, there will still be three (3) Community Builder Lots ($30\% \times 9 = 2.7$, rounded up to 3). The Community Builder Lots will be selected mutually by the Agency and Developer for the entire Project Site as a mutual condition to Closing Parcel A-1. Developer is allowed to develop Vertical Improvements on the Community Builder Lots only if Developer or Affiliates of Developer enter into joint ventures or other arrangements with Community Builders, consistent with Section 15.6. If Developer or Affiliates of Developer do not do so, then Community Builders have certain rights of refusal to develop the Community Builder Lots, as set forth in 15.4.

Community Builder Purchase and Sale Agreement has the meaning set forth in Section 15.4.

Community Facility Parcels or **Community Facilities Parcels** means the parcels retained by the Agency and designated for ultimate disposition for community development or community facilities. Attachment 2 shows the Community Facility Parcels on Phase 1 as tentatively agreed upon as of the Effective Date, but the final selection (as referenced in Section 6.6(c)(11)) will be based on the status and timing of the Navy's remediation efforts

and other development factors, such as synergy with the other Agency Parcels and the rest of the planned development for Phase 1.

Complete Appraisal has the meaning set forth in Section 15.3(b).

Complete Construction means (a) that a specified scope of work has been completed in accordance with mutually approved plans and specifications; (b) public agencies with jurisdiction have issued all permits, licenses, approvals, certificates of occupancy and other sign-offs required for the contemplated use and occupancy of the scope of work; (c) the site has been cleaned and all equipment, tools and other construction materials and debris have been removed; (d) all bills for the scope of work have been paid, any surety has consented to final payment, no mechanics' liens have been recorded and the period for recording mechanics' liens has expired; and (e) all as-built plans and warranties, guaranties, operating manuals, operations and maintenance data, certificates of completed operations or other insurance, and all other close-out items required under the pertinent construction contract, have been provided.

Conceptual Framework has the meaning set forth in Recital H.

Construction Disputes has the meaning set forth in Section 12.1.

Construction Documents means working drawings and specifications setting forth the requirements for construction of a particular scope of work in sufficient detail so that a reasonably experienced general contractor can prepare a responsive bid.

Conveyance Agreement has the meaning set forth in Recital D.

Declaration of Restrictions means the Redevelopment Area Declaration of Restrictions, a copy of which is attached as Attachment 5, as it may be amended from time to time.

Design Review and Document Approval Procedure for Infrastructure Development means the document referenced in Section 6.6(c)(8)(a).

Design Review and Document Approval Procedure for Vertical Improvements means the document referenced in Section 6.6(c)(8)(i).

Developer has the meaning set forth in the preamble to this Agreement.

Developer/Community Builder Venture has the meaning set forth in Section 15.4.

Effective Date has the meaning set forth in the preamble to this Agreement.

Engineer/Architect means a duly licensed design professional, who may be either an engineer or an architect, designated by the Agency from time to time to issue the Engineer's/Architect's Certificates, and to perform the other services, contemplated under this Agreement.

Engineer's/Architect's Certificates has the meaning set forth in Sections 4.3 and 4.4(a) and are in the forms set forth in Attachments 18, 19 and 20.

Environmental Laws has the meaning set forth in Section 7.2(c).

Escrow has the meaning set forth in Section 6.4(a).

Event of Default has the meaning set forth in Section 13.2 (as to Developer) and in Section 13.4 (as to the Agency).

Exclusive Negotiations Agreement or **ENA** has the meaning set forth in Recital G.

Fair Market Value means the cash purchase price that a willing buyer would pay to a willing seller at the time of sale, neither being under a compulsion to buy or sell, and both being fully aware of relevant facts, and without linking the cash price to any other consideration offered by Developer. The Fair Market Value will consider the Lots as finished lots (with views, if applicable) entitled pursuant to the Vertical DDA, located in a master planned community in an urban center and improved with extensive public and private infrastructure, including without limitation the Third Street Light Rail Project. The Parties acknowledge that lots at Mission Bay, to the extent similar in terms of product type, size, views, amenities and the like, may provide useful comparables, depending on the proximity in time between the appraisal of the Lot and the relevant Mission Bay transaction.

Financing and Revenue Sharing Plan means the document attached hereto as Attachment 25, as it may be amended from time to time.

Finding of Suitability for Transfer or **FOST** has the meaning set forth in Recital D.

Guarantor has the meaning set forth in the preamble to this Agreement.

Guaranty has the meaning set forth in the preamble to this Agreement and is in the form of Attachment 8.

Hazardous Substance(s) has the meaning set forth in Section 7.2(b).

Inclusionary Unit means an Affordable Housing Unit to be constructed by a Vertical Developer pursuant to the Affordable Housing Program set forth in Attachment 22, which shall be either For-Rent or For-Sale housing offered in accordance with the terms of the Affordable Housing Program. Inclusionary Units shall be substantially equivalent in size, location, amenities and quality to the Market Rate Units within the Residential Project of which they are a part, and will reflect the mix of Residential Unit sizes and room configurations contained within, and be dispersed among, the Vertical Developer's Market Rate Residential Units in each Residential Project. Inclusionary Units will be located within every block, and each housing type within those blocks must contain Inclusionary Units. Inclusionary Units may not be located outside of the Residential Project for which an obligation arises.

Indemnified Party (Parties) has the meaning set forth in Section 7.2(a).

Infrastructure or Horizontal Improvements means those items identified in the Infrastructure Plan including street systems and street improvements, wet utilities, dry utilities, public Open Space and other improvements to be constructed in or for the benefit of the Redevelopment Area or any other matters described in the Infrastructure Plan.

Infrastructure Plan means the document attached as Attachment 9, as it may be amended from time to time.

Interagency Cooperation Agreement means the document referenced in Section 6.6(c)(8)(b).

Interim Lease means the document attached as Attachment 29, as it may be amended from time to time.

Losses has the meaning set forth in Section 7.2(a).

Lot(s) means the Affiliate Lots and the Community Builder Lots, collectively, or individually as the context requires.

Market Rate Unit(s) or Market Rate Residential Unit means a Residential Unit that has no restrictions under the Affordable Housing Program or this Agreement with respect to affordability levels or income restrictions for occupants.

Marketing Period has the meaning set forth in Section 15.3(c).

Mediator has the meaning set forth in Section 12.2.2(a).

Mello-Roos Bonds has the meaning set forth in Attachment 25.

Minimum Purchase Price has the meaning set forth in Section 15.1.

Mortgage means any mortgage, deed of trust, financing lease, indenture, trust agreement, reimbursement agreement, certificate of participation, collateral assignment or other agreement or instrument (including without limitation any derivative agreement, swap, hedge, forward purchase or other instrument relating to any of the above) creating or evidencing a security interest in, encumbrance upon, securitization of or lien against a Lot or any income, rentals, revenue, profits or other proceeds derived from the Lot to secure a loan the proceeds of which will be used to develop Vertical Improvements on the Lot in accordance with this Agreement.

Navy has the meaning set forth in Recital A.

Open Space means the parcels retained by the Agency and designated for parks, public recreation and other open space uses, portions of which are designated as Open Space on the map attached as Attachment 2.

Open Space Master Plan means an open space, parks and recreation master plan for design and development of the Open Space governing hardscape materials, planting materials, access, amenities and other design elements.

Option: Alternative Financing and Revenue Sharing Plan means the document attached as Attachment 26, which sets forth Developer's option to elect a specified alternative to the compensation structure set forth in the Financing and Revenue Sharing Plan, as it may be amended from time to time.

Outside Closing Dates has the meaning set forth in Section 6.7(d).

Parcel A-1 has the meaning set forth in Recital D.

Parcel B-1 has the meaning set forth in Recital D.

Party or Parties has the meaning set forth in the preamble to this Agreement.

Permitted Exceptions means those title exceptions referenced in Section 6.4.

Person means any natural person, corporation, firm, partnership, association, joint venture, governmental or political subdivision or agency or any similar entity.

Phase 1 has the meaning set forth in Recital D.

Phase 2 ENA has the meaning set forth in Recital H.

Post-Exchange SLC Land has the meaning set forth in the definition of SLC Land.

Pre-Exchange SLC Land has the meaning set forth in the definition of SLC Land.

Preliminary Development Concept or PDC has the meaning set forth in Recital H.

Project Site means that certain real property in the City more particularly described on Attachment 1. The Project Site does not include the Agency Parcels.

PTR Package has the meaning set forth in Section 6.4(b).

Quiet Title Action has the meaning set forth in Section 6.4(c).

Qualified Buyer means a third-party buyer who is not an Affiliate of Developer or a Community Builder and who is reasonably creditworthy given the obligations it is assuming, and the principals of which have at least five (5) years of experience in developing the kind of housing or commercial product to be developed on the Lot the Qualified Buyer is seeking to purchase. Reasonable creditworthiness will be assumed if the Qualified Buyer qualifies for a loan consistent with the mortgage provisions in the Vertical DDA on the Lot the Qualified Buyer is seeking to purchase.

Quitclaim Deed means the quitclaim deed(s) by which the Project Site will be conveyed to Developer in the form attached as Attachment 3.

Rainy Season means the period generally from October 15 to April 15, unless other periods are specified by governing bodies issuing required grading and other construction permits.

Real Estate Brokerage Agreement has the meaning set forth in Section 15.3(c).

Redevelopment Area means the Hunters Point Naval Shipyard Redevelopment Area described in the Redevelopment Plan, as it may be amended from time to time.

Redevelopment Plan has the meaning set forth in Recital B, as it may be amended from time to time.

Redevelopment Requirements means the Redevelopment Plan, the Declaration of Restrictions and this Agreement.

Release has the meaning set forth in Section 7.2(d).

Released Parties has the meaning set forth in Section 7.1(b).

Residential Unit means a dwelling unit consisting of a room or suite of two (2) or more rooms that is designed for residential occupancy for thirty-two (32) consecutive days or more, with or without shared living spaces, such as kitchens, dining facilities or bathrooms.

Residential Project has the meaning set forth in Section 2 of Attachment 22.

Restricted Use Appraisal Report has the meaning set forth in Section 15.2.

Reversionary Grant Deed has the meaning set forth in Section 13.3(c) and is attached as Attachment 6.

Schedule of Performance for Infrastructure Development means the document attached as Attachment 10, as it may be amended from time to time. (The Vertical DDA will include a Schedule of Performance for Vertical Improvements, as well as a Schedule of Performance for the Agency Housing Parcels.)

Shipyard has the meaning set forth in Recital A.

Short Term License Agreement means the document attached as Attachment 4, as it may be amended from time to time.

Significant Change means (a) Developer or either Guarantor files, or is the subject of, a petition for bankruptcy, or makes a general assignment for the benefit of its creditors, (b) a receiver is appointed on account of Developer's or either Guarantor's insolvency, (c) a writ of execution or attachment or any similar process is issued or levied against any bank accounts of Developer or either Guarantor, or against any property or assets of Developer being

used or required for use in the development of the Infrastructure or against any substantial portion of any other property or assets of Developer or either Guarantor or (d) a final non-appealable judgment is entered against Developer in an amount in excess of Five Million Dollars (\$5,000,000.00), or judgment is entered against either Guarantor in an amount in excess of ten percent (10%) of the Guarantor's Tangible Net Worth (as defined in the Guaranty), and the party against whom judgment is entered is unable to either satisfy or bond the judgment.

SLC Land means that portion of the Project Site subject to the State of California's public trust doctrine as shown on Schedule A of Attachment 2. The "Pre-Exchange SLC Land" (as further defined in Section 6.3) is the land subject to the public trust as of the Effective Date that the Parties intend to remove from the public trust, as shown on Schedule A of Attachment 2. The "Post-Exchange SLC Land" (as further defined in Section 6.3) is the land that the Parties intend to subject to the public trust if and when the public trust exchange the Parties are pursuing is effected, at which time the Pre-Exchange SLC Land will be released from the public trust, as shown on Schedule A of Attachment 2.

SLC Lease has the meaning set forth in Section 6.3(b).

SLC Lease Land has the meaning set forth in Section 6.3(b).

Subdivision Map Ordinance and Regulations means the document referenced in Section 6.6(c)(8)(c).

Third-Party Purchase and Sale Agreement has the meaning set forth in Section 15.3(c).

Title Company has the meaning set forth in Section 6.4(a).

Title Objection Period has the meaning set forth in Section 6.4(b).

Title Report has the meaning set forth in Section 6.4(b).

Transfer means to sell, assign, convey, lease, sublease, mortgage, hypothecate or otherwise alienate, excluding therefrom any grant of occupancy rights, such as space leases, for improvements within the Redevelopment Area, to the extent permitted under the Interim Lease.

Transferee means an Affiliate of Developer, Qualified Buyer, Developer/Community Builder Venture or Community Builder, or the Agency, as the case may be, to whom Lots are sold in accordance with Section 15.

Transportation Management Plan means the document attached as Attachment 28, as it may be amended from time to time.

Unavoidable Delay means a delay in a Party's performance of its obligations hereunder that is caused by (a) acts of God, enemy action, civil commotion, fire, flood, earthquake or other casualty, (b) strikes or other labor disputes (to the extent not resulting from the labor practices of the Party claiming the benefit of Unavoidable Delay), (c) material shortages of or inability to obtain labor or materials beyond the reasonable control of the Party

claiming the benefit of Unavoidable Delay, (d) lawsuits brought by plaintiffs unaffiliated with the Party claiming the benefit of Unavoidable Delay, (e) material restrictions imposed or mandated by governmental or quasi-governmental entities beyond the reasonable control of the Party claiming the benefit of Unavoidable Delay, (f) delays by governmental or quasi-governmental entities in issuing requisite approvals or consents beyond the reasonable control of the Party claiming the benefit of Unavoidable Delay, including without limitation failure of the Agency and/or the City to respond to Developer's submissions within the time periods set forth in the Interagency Cooperation Agreement or the Design Review and Document Approval Procedure for Infrastructure Development or (g) any other event beyond the reasonable control of the Party claiming the benefit of Unavoidable Delay. Delays beyond a Party's reasonable control exclude delays to the extent caused by the negligent act or omission or willful misconduct of the Party claiming the benefit of Unavoidable Delay.

Unit(s) has the meaning set forth in Attachment 22.

Unrelated Buyer means a third-party in an arms-length transaction who is not an Affiliate of the Vertical Developer.

Vertical DDA means the form of Disposition and Development Agreement for the Vertical Development incorporating the terms and conditions included in Attachment 27, as modified to reflect the Lot and Vertical Development in question.

Vertical Developer(s) means Affiliates of Developer, Qualified Buyers, Developer/Community Builder Ventures and Community Builders, as the case may be, acquiring Lots for the development and construction of Vertical Improvements in accordance with Section 15.

Vertical Development means the process of planning, executing and completing Vertical Improvements.

Vertical Improvements has the meaning set forth in the Vertical DDA.

Work, when used in reference to Abandonment, means Developer's (a) performance of substantial physical construction of Horizontal Improvements, (b) expenditure of a substantial sum of money for design activity on the Horizontal Improvements within a reasonable period of time or (c) diligent efforts, including the expenditure of a substantial sum of money, to obtain or actually obtaining approval(s) necessary to Commence Construction of the Horizontal Improvements. Abandonment has a correlative meaning.

1.2 Interpretation. Unless otherwise specified, whenever in this Agreement, including its Attachments, reference is made to the Table of Contents, any Section or Attachment, or any defined term, the reference shall be deemed to refer to the Table of Contents, Section or Attachment, or defined term of this Agreement. Any reference to a Section includes all subsections and subparagraphs of that Section. The use in this Agreement of the words "including," "such as" or words of similar import when following any general term, statement or matter shall not be construed to limit such statement, term or matter to the specific items or matters, whether or not language of non-limitation, such as "without limitation" or "but not

limited to,” or words of similar import, is used with reference thereto, but rather shall be deemed to refer to all other items or matters that could reasonably fall within the broadest possible scope of such statement, term or matter. In the event of a conflict between the Recitals and the remaining provisions of the Agreement, the remaining provisions shall prevail. Any titles of the several parts and sections of this Agreement are inserted for convenience of reference only and shall be disregarded in construing or interpreting any of its provisions. The terms “Paragraph” and “Section” may be used interchangeably. The masculine, feminine or neutral gender and the singular and plural forms include the others whenever the context requires. Defined terms and variants thereof shall have the same definition, *e.g.*, the defined term Commence Construction shall include Commencement of Construction, Commencing Construction and similar variants. References to days, months and years mean calendar days, months and years unless otherwise specified. Accounting terms and financial covenants will be determined, and financial information must be prepared, in compliance with Generally Accepted Accounting Principles (“GAAP”) as in effect on the date of performance. References to any law, specifically or generally, will mean the law as amended, supplemented or superseded from time to time.

SECTION 2. TERM OF AGREEMENT

2.1 Relationship Between Terms and Conditions Applicable to Infrastructure and Vertical Improvements. This Agreement applies in the first instance to Infrastructure, but it also includes the terms and conditions that will apply to Vertical Improvements. There are also significant numbers of terms and conditions that apply to both Infrastructure and Vertical Improvements, *e.g.*, prevailing wage requirements. For clarity, the Vertical DDA comprises the terms and conditions that will apply to Vertical Improvements, and it incorporates by reference certain Attachments to this Agreement which will apply to both Infrastructure and to Vertical Improvements. The relationship between the terms and conditions that apply to Infrastructure and those that apply to Vertical Improvements is reflected in Sections 2.2 and 2.3.

2.2 Infrastructure. The term of this Agreement shall commence upon the Effective Date and, as to Sections other than Section 15.5 and Attachments other than the Vertical DDA (and the other Attachments specifically incorporated in the Vertical DDA), will continue until the sale of the final Lot under this Agreement, unless earlier terminated as provided in this Agreement. Upon a Vertical Developer’s request, the Agency shall cause the lien of this Agreement to be released as to a particular Lot concurrently with the first sale of that Lot to a Transferee, to be replaced by the Vertical DDA incorporating the terms and conditions included in Attachment 27 in accordance with Section 15.5 and modified to reflect the obligations of the Vertical Developer(s) in question as they apply to the particular Lot(s). Indemnities and other obligations that are intended to survive partial release, expiration or termination will survive any partial release, expiration or termination.

2.3 Vertical Improvements. The provisions of Section 15.5 and the Vertical DDA (and the other Attachments specifically incorporated in the Vertical DDA) shall continue until the sale of the final Unit to an Unrelated Buyer, unless earlier terminated as provided in this Agreement. As indicated in the Vertical DDA, upon the Vertical Developer’s request the Agency shall cause the lien of the Vertical DDA (and the other Attachments specifically incorporated in the Vertical DDA that are not intended to survive sale of a Unit) to be released as to a particular Unit concurrently with the first sale of that Unit to an Unrelated Buyer.

Indemnities and other obligations that are intended to survive partial release, expiration or termination will survive any partial release, expiration or termination.

SECTION 3. LAND USES

The particular land uses are shown on the Redevelopment Plan and on the Land Use Plan attached as Schedule B of Attachment 2, and will be refined in the Amended Design for Development for Vertical Improvements. As more specifically described in the Infrastructure Plan, Developer shall construct Infrastructure on the Project Site and the Agency Parcels as provided herein. As a guiding principle, the Infrastructure located on and serving the Agency Parcels, including without limitation the Community Facilities Parcels, will be equivalent in quality, sizing, capacity and all other features to the Infrastructure located on and serving the Project Site, with necessary variations related to physical conditions, *e.g.*, sloping, that may require different engineering solutions. Sustainable or “green” techniques will be integrated as part of the Infrastructure and sustainable development and environmental stewardship will be incorporated in all aspect of construction within the Open Space. In addition, Developer will use commercially reasonable efforts to retain the Dago Mary’s restaurant and bar in the location it occupies as of the Effective Date, or relocate it to a location reasonably acceptable to Developer and the Agency in consultation with the owners of Dago Mary’s.

SECTION 4. INFRASTRUCTURE OR HORIZONTAL DEVELOPMENT

4.1 Developer’s Construction Obligations. Developer shall construct the Infrastructure in strict accordance with the Infrastructure Plan, Schedule of Performance for Infrastructure Development and Transportation Management Plan. Developer will Commence Construction of the Infrastructure on the date specified in the Schedule of Performance for Infrastructure Development and will diligently prosecute the work in order to Complete Construction of the Infrastructure by the dates specified in the Schedule of Performance for Infrastructure Development, subject to the terms of this Agreement, including Section 22.5 hereof regarding Unavoidable Delay; provided that, if Close of Escrow for either Parcel A-1 or Parcel B-1 occurs at a time that would require construction activities materially affected by rain, *e.g.*, grading, to be undertaken during the Rainy Season, then Developer will be entitled to a day-for-day extension to the extent (a) Developer’s construction logistics plan shows it is infeasible to proceed with such construction activities because of rain or (b) Developer is able to show that, despite Developer’s commercially reasonable efforts, governmental bodies refused to issue required grading or other construction permits (or if the permits were issued, refused to allow work under the permits) because the work subject to the permits was scheduled to occur during the Rainy Season. All Infrastructure will be constructed in a good and workmanlike manner, without material defects, in accordance with approved Construction Documents and all applicable Authorizations, laws, codes, rules and regulations (including without limitation applicable federal, state and local environmental justice regulations, including the new State of California General Plan Guidelines for 2003 issued by the Governor’s Office of Planning and Research).

4.2 Approval of Construction Plans. The Agency, the City and Developer shall comply with the Design Review and Document Approval Procedure (“DRDAP”) for Infrastructure Development and the Interagency Cooperation Agreement.

4.3 Conditions to Commencement of Construction. Prior to Commencing Construction of the Horizontal Improvements, Developer shall satisfy the following conditions precedent, to the extent not expressly waived by the Agency in writing:

(a) Developer shall have submitted Construction Documents to the Agency or its staff for review and shall have obtained the Agency approval of same pursuant to the Design Review and Document Approval Procedure (DRDAP) for Infrastructure Development, if and when agreed upon and effective;

(b) Agency staff shall have issued an Engineer's/Architect's Certificate Re Compliance of Design with Laws Re Access, in the form of Attachment 18;

(c) A Building Permit (or if the site permit type of Building Permit process is utilized, the first addendum to the site permit) for the Infrastructure proposed to be commenced shall have been issued;

(d) Developer shall have certified in writing to the Agency (i) the date Developer anticipates it will Commence Construction, (ii) that it is ready, willing and able to Commence Construction of the Infrastructure and Complete Construction of the Infrastructure in accordance with the terms and conditions of this Agreement and the approved Construction Documents and (iii) that the relevant conditions to Closing set forth in Section 6 have either been satisfied or waived in accordance with this Agreement; and

(e) There shall be no Developer Event of Default under this Agreement, nor any event, act or omission that with notice and the expiration of any cure period without cure would become a Developer Event of Default.

4.4 Issuance of Certificates of Completion.

(a) From and after the date on which Developer shall have Completed Construction of all of the Infrastructure, or portions of the Infrastructure serving individual Lots or Agency Parcels as described in the Infrastructure Plan, Developer may request Engineer or Architect to issue recordable "Engineer's/Architect's Certificates" verifying that Developer has Completed Construction of the specified Infrastructure, substantially in the forms of Attachments 19 and 20 (Attachment 20 relates to compliance of construction with laws regarding access). Within twenty (20) days after Developer's written request, Engineer or Architect will issue the appropriate Engineer's/Architect's Certificates to Developer and to the Agency in duplicate originals. Within twenty (20) days after its receipt of the Engineer's/Architect's Certificate, if the Agency agrees that Developer has Completed Construction of the specified Infrastructure, it will issue to Developer in a recordable form an appropriate, "Certificate of Completion" for the Infrastructure substantially in the form of Attachment 21, which Developer will promptly record in the City's official records. The Certificate of Completion shall be a determination that Developer has Completed Construction of the specified Infrastructure in accordance with this Agreement, except for latent defects, but such determination does not impair the Agency's right to indemnity under Section 17. Following recordation of the Certificate of Completion for the Infrastructure serving an individual Lot or Agency Parcel, any Person then owning or thereafter purchasing, leasing or otherwise acquiring any interest in such

Lot or Agency Parcel shall not, by virtue of such ownership, purchase, lease or acquisition, or by virtue of such person's actual or constructive knowledge of the contents of this Agreement, incur any obligation or liability under this Agreement with respect to the construction of the Infrastructure serving such Lot or Agency Parcel (but such Person will be subject to the Vertical DDA and the Attachments specifically incorporated in the Vertical DDA).

(b) The Agency's issuance of any Certificate of Completion does not relieve Developer or any other Person from any building, fire or other construction code requirements or conditions to occupancy of any improvement, which requirements or conditions must be complied with separately.

4.5 Failure to Issue Engineer's/Architect's Certificates or Certificates of Completion. If the Engineer or Architect refuses or fails to issue an Engineer's/Architect's Certificate, or the Agency refuses or fails to issue a Certificate of Completion, within the time periods specified in Section 4.4, then within such time periods the Engineer, Architect or the Agency, as the case may be, will deliver to Developer (and in the Engineer's or Architect's case to the Agency as well), a written statement setting forth in adequate detail the basis for such refusal or failure and the measures which Developer must undertake in order to obtain the requested Engineer's/Architect's Certificate or Certificate of Completion. Notwithstanding any other provision of this Agreement, disputes regarding the refusal or failure to issue an Engineer's/Architect's Certificates are Construction Disputes subject to the provisions of Section 12, but disputes regarding the Agency's refusal or failure to issue a Certificate of Completion are not Construction Disputes and are not subject to the provisions of Section 12.

SECTION 5. INSURANCE

5.1 Environmental Insurance. The Parties shall reasonably cooperate with each other to obtain environmental insurance in the manner set forth in Section I of Attachment 7. The costs of obtaining and maintaining such environmental insurance shall be allocated between the Parties as set forth in Section I of Attachment 7.

5.2 Other Insurance. Developer shall provide other insurance in the forms and amounts, and subject to the terms and conditions, described in Attachment 7.

SECTION 6. TERMS FOR CONVEYANCE OF PROJECT SITE TO DEVELOPER

6.1 General. Subject to all of the terms, covenants and conditions of this Agreement, the Agency agrees to convey the Project Site to Developer, and Developer agrees to acquire the Project Site from the Agency, for the purposes of developing and constructing the Infrastructure and then selling the Lots to Vertical Developers for the purpose of developing and constructing the Vertical Improvements. The Parties acknowledge that Parcel A-1 will very likely be ready for conveyance prior to Parcel B-1. Therefore, the parties shall bifurcate the Close of Escrow so that there are separate Closings for Parcel A-1 and for Parcel B-1.

6.2 Developer's Option. As set forth in Attachment 26, this Agreement grants to Developer an option for a limited period to purchase the Agency's interest in the Project Site through an up-front lump sum payment and the right to participate in revenues from Vertical Development. If the Developer timely exercises such option, then the provisions specified in

Attachment 26 will supersede the contrary provisions in this Agreement. This option does not affect the Agency's rights and interest in and to the Agency Parcels, comprising the Agency Housing Parcels, the Community Facility Parcels and the Open Space.

6.3 SLC Provisions. The Parties contemplate that the Pre-Exchange SLC Land will be removed from the public trust and the Post-Exchange SLC Land will be made subject to the public trust if the public trust exchange the Parties are pursuing is effected. The following provisions will govern if the public trust exchange has not been fully effected prior to the Close of Escrow on Parcel A-1 or Parcel B-1, as the case may be.

(a) **Parcel A-1.** If at the time for Close of Escrow on Parcel A-1, the applicable portions of Parcel A-1 have not been removed from the public trust to the extent shown in Schedule A of Attachment 2 (the "Post-Exchange SLC Land"), then the Agency and Developer shall exclude that portion of Parcel A-1 that is still subject to the public trust from the scheduled Closing and instead convey it as soon as practicable after it has been removed from the public trust. In that event, the Agency and Developer shall use commercially reasonable efforts to complete the public trust exchange as soon as practicable after the Close of Escrow on Parcel A-1. After the public trust exchange has been effected, Developer shall execute such instruments as may be necessary to subject any portion of Parcel A-1 that was initially conveyed to it to the public trust to the extent shown in Schedule A of Attachment 2, and the Agency shall deliver a quitclaim deed to Developer in mutually satisfactory form for any portion of Parcel A-1 that was excluded from the initial conveyance because it was subject to the public trust, but from which the public trust has been removed.

(b) **Parcel B-1.** It is a condition precedent to Close of Escrow on Parcel B-1, for both Developer and the Agency, that Parcel B-1 has been removed from the public trust, as shown on the Map depicting the Post-Exchange SLC Land attached hereto as Schedule A of Attachment 2, provided that, the Parties instead may elect to enter into a mutually acceptable lease, meeting the requirements of the State Lands Commission, covering that portion of Parcel B-1 then comprising part of the "Pre-Exchange SLC Land" as shown on Schedule A of Attachment 2 (the "SLC Lease" covering the "SLC Lease Land"). In that event, (i) the Closing for conveyance of Parcel B-1 from the Agency to Developer will be through a Quitclaim Deed for that portion of Parcel B-1 other than the SLC Lease Land, and through the SLC Lease for the SLC Lease Land and (ii) the Agency and Developer shall use commercially reasonable efforts to complete the public trust exchange, in order to remove the SLC Lease Land from the public trust, as soon as practicable after the scheduled Closing for Parcel B-1. The SLC Lease will terminate when the public trust exchange has been effected. Concurrently with termination, (i) Developer shall deliver a quitclaim deed to the Agency in mutually satisfactory form for any portion of Parcel B-1 that was initially conveyed to it and that became subject to the public trust after the exchange, to the extent shown in Schedule A of Attachment 2, and the Parties will then enter into a new SLC lease in mutually satisfactory form for such property from the Agency to Developer and (ii) the Agency shall deliver a quitclaim deed to Developer in mutually satisfactory form for the SLC Lease Land.

6.4 Escrow and Title.

(a) **Escrow.** Within two (2) Business Days after the Effective Date, Developer shall establish an escrow (“Escrow”) with Chicago Title Company (“Title Company”) and shall promptly notify the Agency in writing of the Escrow number and contact person.

(b) **Title.** Within ten (10) Business Days after the Effective Date, Developer shall cause the Title Company to deliver to the Agency and Developer preliminary title reports or commitments for title insurance for each of Parcel A-1 and B-1, together with copies of all documents relating to title exceptions shown in the “Title Report” (collectively, the “PTR Package”). Other than exceptions created by or on behalf of Developer (which shall be deemed to be Permitted Exceptions except to the extent required to be removed by Developer under this Agreement, in which event Developer will remove the exception), Developer may object to any exceptions shown on the PTR Package which materially and adversely affect Developer’s use of the Project Site as permitted under this Agreement. Developer must notify the Agency of any such objection within ten (10) days after Developer receives the PTR Package (the “Title Objection Period”). If Developer fails to so object within the ten (10) day period, then all of the exceptions shown on the PTR Package will be deemed to be Permitted Exceptions. If Developer does so object within the ten (10) day period, then the Agency at its cost will remove any exceptions created by or on behalf of the Agency prior to the Close of Escrow, and in its sole discretion may elect to remove or otherwise cause the Title Company not to show any other exception on the owner’s title insurance policy to be issued to Developer at Closing. If the Agency does so elect, it will notify Developer within thirty (30) days after receipt of Developer’s objection. If the Agency elects not to remove the exception, or fails to respond within the thirty (30) day period, then Developer shall have the right to (i) terminate this Agreement by written notice to the Agency delivered within ten (10) days after Developer receives the Agency’s written notice that it has elected not to remove the exception or expiration of the thirty (30) day period, whichever occurs earlier, or (ii) accept title to the Project Site subject to such exception. If Developer fails to so terminate within the ten (10) day period, then it shall be deemed to have elected clause (ii) above. Exceptions which the Agency elects not to remove, or is deemed to have elected not to remove, and which Developer elects to accept, or is deemed to have accepted, are also Permitted Exceptions.

(c) **Quiet Title Action.** Notwithstanding the Agency’s rights not to cure exceptions under Section 6.4(b), the Agency, with Developer’s cooperation, shall complete an action under the Destroyed Land Records Relief Law (California Code of Civil Procedure §§ 751.01 *et seq.*) to remove paper streets (and other exceptions customarily subject to removal by a quiet title action) that show on the PTR Package and to which Developer timely objected under Section 6.4(b) (the “Quiet Title Action”). In the event that Developer waives the provisions of Section 6.6(c)(6) hereof, or otherwise accepts title subject to exceptions that would be eliminated by such Quiet Title Action, the Agency, with Developer’s cooperation, shall complete the Quiet Title Action as soon as commercially reasonable and the Parties shall then undertake to cause the issuance of the title insurance prescribed in Section 6.6(c)(6), or an amendment or endorsement thereto, reflecting the elimination of such exceptions. The cost of the Quiet Title Action shall be deemed an Approved Expense to the extent included in an Approved Budget under the Financing and Revenue Sharing Plan. At each Closing, and subject

to Section 6.3, the Agency shall convey to Developer all of its right, title and interest to Parcel A-1 or Parcel B-1, as applicable, by an instrument substantially in the form of Attachment 3.

(d) **Title Policy.** It is a condition to the Parties' obligations to Close on each of Parcel A-1 and on Parcel B-1 that the Title Company shall be irrevocably committed to issue to Developer a CLTA owner's title insurance policy (or at Developer's option an ALTA owner's title insurance policy), with such endorsements, reinsurance and direct access agreements as Developer shall reasonably designate and the Title Company shall accept. The title policy will be in an amount designated by Developer and acceptable to the Title Company, and will insure that fee title to Parcel A-1 or Parcel B-1, as the case may be, and all easements appurtenant thereto are vested in Developer, subject only to the Permitted Exceptions and such other encumbrances as are contemplated by this Agreement. If Developer elects to obtain an ALTA owner's policy, Developer shall be responsible for securing any and all surveys, engineering studies and other documents required to obtain an ALTA owner's policy, in sufficient time to permit Close of Escrow as required by this Agreement, the cost of which shall be deemed an Approved Expense to the extent included in an Approved Budget under the Financing and Revenue Sharing Plan. The Parties shall use commercially reasonable efforts to obtain a pro-forma title policy for Parcel A-1 or Parcel B-1, as the case may be, prior to Close of Escrow on the relevant parcel, and any such pro-forma title policy shall be attached to this Agreement.

(e) **New Title Matters.** If after the Title Objection Period has expired, a new title exception not shown on the PTR Package arises which materially and adversely affects Developer's use of the Project Site as permitted under this Agreement, other than exceptions created by or on behalf of Developer (which shall be deemed to be Permitted Exceptions except to the extent required to be removed by Developer under this Agreement, in which event Developer will remove the exception), then Developer may object to such new exception by written notice to the Agency within ten (10) days after Developer first receives written notice of the new exception. If Developer fails to so object within the ten (10) day period, then the new exception will be deemed to be a Permitted Exception. If Developer does so object within the ten (10) day period, then the Agency at its cost will remove any exceptions created by or on behalf of the Agency prior to the Close of Escrow, and in its sole discretion may elect to remove or otherwise cause the Title Company not to show any other exception on the owner's title insurance policy to be issued to Developer at Closing. If the Agency does so elect, it will notify Developer within thirty (30) days after receipt of Developer's objection. If the Agency elects not to remove the exception, or fails to respond within the thirty (30) day period, then Developer shall have the right to (i) terminate this Agreement by written notice to the Agency delivered within ten (10) days after Developer receives the Agency's written notice that it has elected not to remove the exception or expiration of the thirty (30) day period, whichever occurs earlier, or (ii) accept title to the Project Site subject to such exception. If Developer fails to so terminate within the ten (10) day period, then it shall be deemed to have elected clause (ii) above. Exceptions which the Agency elects not to remove, or is deemed to have elected not to remove, and which Developer elects to accept, or is deemed to have accepted, are also Permitted Exceptions.

6.5 Agency Parcels. At the Close of Escrow on Parcel A-1, the Parties shall enter into a Short Term License Agreement in the form attached as Attachment 4 allowing for entry upon the Agency Parcels, for purposes of the design and construction of certain Infrastructure

serving the Agency Parcels or any other portions of the Project Site, as described in the Infrastructure Plan.

6.6 Conditions Precedent to Closing.

(a) **Developer Conditions to Closing.** The following are conditions precedent to Developer's obligation to Close Escrow for the conveyance of each of Parcel A-1 and Parcel B-1 (unless otherwise expressly specified), to the extent not expressly waived by Developer by written notice to the Agency:

(1) The Agency shall have performed all obligations under this Agreement required to be performed by the Agency prior to the date for the Close of Escrow on Parcel A-1 or Parcel B-1, as the case may be, as specified in this Agreement and in the Schedule of Performance for Infrastructure Development; and

(2) There shall have been no Event of Default by the Agency hereunder, nor any event, act or omission which with notice and the expiration of any cure period without cure would become an Event of Default by the Agency.

(b) **Agency Conditions to Closing.** The following are conditions precedent to the Agency's obligation to close Escrow for the conveyance of each of Parcel A-1 and Parcel B-1 (unless otherwise expressly specified), to the extent not expressly waived by the Agency by written notice to Developer (as authorized by the Agency Commission):

(1) Developer shall have performed all obligations under this Agreement required to be performed by Developer prior to the date for Close of Escrow of Parcel A-1 or Parcel B-1, as the case may be, as specified in this Agreement and in the Schedule of Performance for Infrastructure Development, including without limitation (i) paying all amounts owing from Developer to the Agency, (ii) providing the letters of credit or other credit enhancements required by Section 2.1 of Attachment 25 and (iii) executing and delivering the Reversionary Grant Deed and irrevocable instructions from Developer to the Title Company referenced in Section 13.3(c);

(2) Unless the Schedule of Performance for Infrastructure Development requires a more comprehensive approval by the Agency of Construction Documents as of the Date of Closing, at a minimum the Agency shall have approved Construction Documents for the Infrastructure that the Agency agrees are ninety percent (90%) complete and are consistent with the Infrastructure Plan;

(3) Unless the Schedule of Performance for Infrastructure Development requires Developer to be closer to Commencing Construction as of the Date of Closing, at a minimum Developer shall have provided, and the Agency shall have approved, a detailed construction cost estimate for the Infrastructure prepared by a cost estimator reasonably acceptable to the Agency, which estimate is consistent with the construction cost for the Infrastructure set forth in the Preliminary Budget;

(4) Developer shall have certified to the Agency that Developer is ready, willing and able to timely perform the tasks set forth in this Agreement and in the Schedule of Performance for Infrastructure Development;

(5) Developer shall have furnished certificates of insurance or duplicate originals of insurance policies required by this Agreement;

(6) There shall have been no Event of Default by Developer hereunder, nor any event, act or omission which with notice and the expiration of any cure period without cure would become an Event of Default by Developer;

(7) Consistent with Attachment 23, the Agency in consultation with the CAC shall have developed a plan for the CAC and the BVHP Representative Entity (as defined in Attachment 23) to consult on the annual Community Benefits Budget, which sets forth the proposed uses of the net revenues (net of the Agency's administrative costs) received by the Agency under Attachments 25 and 26; and

(8) A qualified, independent third-party shall have verified Developer's actual Qualified Predevelopment Costs and Qualified Pre-Agreement Costs to the Agency's reasonable satisfaction.

(c) Mutual Conditions to Closing. The following are conditions precedent to both Parties' obligations to Close Escrow for the conveyance of each of Parcel A-1 and Parcel B-1 (unless otherwise expressly specified), to the extent not expressly waived by both Developer and the Agency (as authorized by the Agency Commission) in writing:

(1) The applicable conditions in Section 6.3 regarding the public trust exchange have been met;

(2) The conditions in Section 8.2(b) regarding adoption of the Subdivision Map Ordinance and Regulations and implementation of the required subdivision have been met;

(3) The Community Builder Lots for the entire Project Site have been selected by mutual agreement of the Agency and Developer;

(4) The Agreement shall not have terminated;

(5) The Agency shall have fee title to Parcel A-1 or B-1, as the case may be.

(6) The Title Company shall be irrevocably committed to issue to Developer the title insurance required by Section 6.4(d) for Parcel A-1 or Parcel B-1, as the case may be; provided that, Developer may elect to take title subject to completion of the Quiet Title Action necessary to remove the exceptions subject to those actions, in which event the Agency will cause the City to complete the Quiet Title Action as soon as commercially reasonable following the Date of Closing;

(7) It is a Closing condition to Parcel B-1 that Closing has occurred on Parcel A-1;

(8) The Agency and Developer shall have agreed upon mutually satisfactory forms of the following documents prior to the Date of Closing for the initial Parcel to be conveyed from the Agency to Developer, each exercising its sole and absolute discretion in good faith, and the agreed-upon instruments shall have been formally adopted by the Agency Commission and the City's Board of Supervisors, where required:

(a) A Design Review and Document Approval Procedure (DRDAP) for Infrastructure, to be attached to this Agreement when and if agreed upon;

(b) an Interagency Cooperation Agreement, to be attached to this Agreement when and if agreed upon;

(c) a Subdivision Map Ordinance and Regulations, to be attached to this Agreement when and if agreed upon;

(d) a Plan for Environmental Investigation and Remediation During Development at Hunters Point Shipyard, substantially in the form of the draft Plan attached as Attachment 12, and implementing ordinances for each of Parcels A-1 and B-1 formally adopted by the City's Board of Supervisors; when and if agreed upon, the final version of the Plan will be attached as Attachment 12 in lieu of such draft;

(e) a form of Soil and Ground Water Management Plan, to be attached to this Agreement when and if agreed upon;

(f) all documents regarding the sale of the Mello-Roos Bonds, in commercially reasonable forms consistent with customary underwriting standards and Attachment 25;

(g) The Vertical DDA, incorporating the terms and conditions set forth in the Outline of Provisions of Vertical Disposition and Development Agreement attached to this DDA as Attachment 27; when and if agreed upon, the Vertical DDA will be attached as Attachment 27 in lieu of such Outline;

(h) an Amended Design for Development for Vertical Improvements, to be attached to this Agreement when and if agreed upon;

(i) a Design Review and Document Approval Procedure (DRDAP) for Vertical Improvements, to be attached to this Agreement when and if agreed upon;

(j) the Open Space Master Plan and a funding plan for maintaining and operating the Open Space, to be attached to this Agreement when and if agreed upon;

(k) all documents necessary or appropriate to implement the Additional Business, Employment, Construction Assistance/Opportunities and Community Benefits Program attached as Exhibit B to Attachment 24 shall be agreed upon and in effect; and

(l) an Acquisition Agreement for Public Financing, to be attached to Attachment 25 to this Agreement when and if agreed upon.

(9) It is a Closing condition to Parcel B-1 that the Agency Parcels for Parcel B-1 have been selected by mutual agreement of the Agency and Developer. Attachment 2 shows the Agency Parcels as tentatively agreed upon by the Agency and Developer as of the Effective Date, but the final selection will be based on the status and timing of the Navy's remediation efforts, access to Open Space, synergy with other Community Facilities Parcels, similar density between the Agency Parcels and related development and other matters to be identified by the Agency;

(10) It is a Closing condition to Parcel B-1 that the Agency and Developer have agreed upon a plan under which Developer will provide for artists who lease space on Parcel B-1 (as of the Closing Date for Parcel B-1) to continue to rent space in existing facilities at that portion of the Shipyard controlled by Developer until new facilities are built. The relocation facilities, and the new facilities, will provide sufficient space to accommodate at least the number of artists who lease space on Parcel B-1 as of the Effective Date. The plan will be developed in consultation with the artists affected;

(11) It is a Closing condition to each of Parcel A-1 and Parcel B-1, respectively, that the Agency, Developer and the CAC have (a) agreed upon a location for the Interim African Marketplace (which may, on an interim basis, be within the Community Facility Parcels or Open Space, but such interim usage will not reduce the total acreage required in this Agreement for Open Space and Community Facility Parcels) and (b) developed a plan, including a range of acceptable uses for, and the specific location of, the Community Facility Parcels to be located within the Parcel being Closed. The plan will reasonably maximize community participation in, and community benefits from, the Community Facility Parcels. The Parties acknowledge that if prospective uses for the Phase 1 Community Facility Parcels depend on conditions that can be determined only in connection with subsequent phases of development, then the Community Facility Parcels shall be reserved for community uses to be further defined in connection with those later phases;

(12) It is a Closing condition to Parcel A-1 that the Agency and Developer have agreed upon the Minimum Purchase Price for each Lot, which will be based upon the most current Preliminary Budget;

(13) It is a Closing condition to Parcel A-1 that the Agency and Developer have agreed upon the pre-approved Mediators, Arbiters, Appraisers and Brokers referenced in Sections 12.2.2(a) and (d), 15.2, 15.3(c), Attachment 25 and Attachment 26 of this Agreement;

(14) It is a Closing condition to Parcel A-1 that the Agency and Developer have agreed upon a "Demolition and Deconstruction Plan", which will include noise and time restrictions for work undertaken by Developer;

(15) It is a Closing condition to Parcel A-1 that the Agency and Developer have agreed upon an overall energy conservation and green construction plan; and

(16) It is a Closing condition to Parcel A-1 that the Agency and Developer have agreed upon legal descriptions for Phase 1, the Project Site and the Agency Parcels.

6.7 Closing.

(a) **Closing Deliveries.** At least fifteen (15) days prior to the date specified for Close of Escrow in the Schedule of Performance for Infrastructure Development for Parcel A-1 or Parcel B-1, as the case may be, each Party will furnish the Title Company with appropriate escrow instructions consistent with, and sufficient to implement the terms of, this Agreement, and will contemporaneously furnish a copy of these instructions to the other Party. At least two (2) Business Days prior to the date specified for the applicable Close of Escrow, each Party will deposit into Escrow all documents and instruments it is obligated to deposit under this Agreement, and at least one (1) Business Day prior to the date specified for Close of Escrow, each Party will wire transfer into Escrow all funds it is obligated to deposit under this Agreement.

(b) **Conveyance of Title and Delivery of Possession.** Provided that the conditions to the Agency's obligations and the conditions to Developer's obligations with respect to the Parcel A-1 or Parcel B-1, as the case may be, have been satisfied or expressly waived, and the mutual conditions have been satisfied, then the Agency shall convey to Developer, and Developer shall accept the conveyance of, Parcel A-1 or Parcel B-1, as the case may be, on or before the Close of Escrow as required by this Agreement.

(c) **Closing Costs and Prorations.** Developer shall pay to the Title Company or the appropriate payee thereof all title insurance premiums and endorsement charges, transfer taxes, recording charges and any and all escrow fees in connection with the conveyance of Parcel A-1 or Parcel B-1, as the case may be, to Developer, all of which shall be deemed to be Approved Expenses to the extent included in an Approved Budget under the Financing and Revenue Sharing Plan. Ad valorem taxes and assessments, if any, shall be prorated as of the applicable Close of Escrow. Any such taxes and assessments, including supplemental taxes and escaped assessments, levied, assessed, or imposed for any period up to recordation of the applicable Quitclaim Deed, shall be borne by the Agency (unless otherwise provided in the Interim Lease).

(d) **Outside Closing Dates.** Each of Developer and the Agency will use commercially reasonable efforts to satisfy the closing conditions set forth in Section 6.6 which are in its control, and will reasonably cooperate with the other Party to satisfy conditions that are in the other Party's control. If Close of Escrow is delayed because the Agency cannot perform its obligations to execute and deliver the Quitclaim Deed or SLC Lease (if applicable) and the

Agency claims Unavoidable Delay to excuse such delay, then the date specified for the applicable Close of Escrow will be extended for so long as the Agency is excused from performance by Unavoidable Delay. Subject to the preceding sentence and to Section 6.9, if any of the events set forth in the following clauses (i) through (iv) are not achieved by the specified date (the "Outside Closing Date"), then the Agency in its sole discretion may terminate this Agreement by written notice to Developer at any time after the relevant Outside Closing Date, but before all Closing conditions are either satisfied or waived:

(i) Close of Escrow for the initial Parcel comprising a portion of the Project Site has not occurred by the fourth anniversary of the Effective Date because the Agency has not acquired fee title to such Parcel;

(ii) Close of Escrow for the second Parcel comprising a portion of the Project Site has not occurred by the sixth anniversary of the Effective Date because the Agency has not acquired fee title to such Parcel;

(iii) Close of Escrow for the initial Parcel comprising a portion of the Project Site has not occurred by the second anniversary of the date the Agency acquired fee title to such Parcel because the City's Board of Supervisors has failed to approve and adopt or enact (as required) all of the following by that date: an Interagency Cooperation Agreement, a Subdivision Map Ordinance and Regulations, a Plan for Environmental Investigation and Remediation During Development at Hunters Point Shipyard (together with implementing ordinances) and a Soil and Ground Water Management Plan (these are the conditions to Closing specified in Section 6.6(c)(8)(b) through(e));

(iv) The Agency Commission and the City's staff have not approved each of the documents specified in clause (iii) by the first anniversary of the date the Agency acquired fee title to the initial Parcel comprising a portion of the Project Site; or

(v) Close of Escrow for either Parcel comprising a portion of the Project Site has not occurred by the first anniversary of the date the Agency acquired fee title to such Parcel because of a failure of any other condition to Closing set forth in Section 6.6 (excluding those specifically referenced in clauses (i), (ii), (iii) or (iv) above.

Upon such termination, the Parties shall have no further rights or obligations to each other under this Agreement, except for (1) rights and obligations which are expressly stated to survive termination of this Agreement and (2) if the termination is only as to the second Parcel comprising a portion of the Project Site, then this Agreement shall continue in full force and effect as to the initial Parcel.

6.8 Post-Closing Boundary Adjustments. The Agency Parcels as shown on Attachment 2 are not included in the Project Site and shall not be transferred to Developer. The Parties acknowledge that as development of the Project Site and Agency Parcels advances, the description of each Lot and or each Agency Parcel may require further refinements, which may require a boundary adjustment between the Lots and the Agency Parcels. The Parties agree to cooperate in effecting any boundary adjustments required, consistent with this Agreement.

6.9 Termination Notice. So long as a terminating Party under Section 6.7(d) shall have provided the other Party with no less than fifteen (15) days' prior written notice, which notice shall include a copy of the proposed notice of termination, then either Party may cause to be recorded in the City's official records a notice of termination of this Agreement at any time after the date of termination. The termination notice shall describe the portion of the Redevelopment Area to which the termination pertains. In addition, upon the Agency's request, Developer will execute, in recordable form, and deliver to the Agency a standard Title Company form quitclaim deed quitclaiming to the Agency all of Developer's right, title and interest in Parcel A-1 and/or Parcel B-1, as the case may be. However, this Section 6.9 will not prevent either Party from claiming that the failure of a condition arose from an Event of Default by the other Party, and from pursuing its legal and equitable rights and remedies against the other Party arising from the alleged Event of Default, including without limitation the right to specific performance.

SECTION 7. PROPERTY CONDITION

7.1 As Is.

(a) The Parties acknowledge that the Agency will receive the Project Site by quitclaim deed from the Navy. The parties further acknowledge that, following this conveyance to the Agency, Developer and the Agency will enter into an Interim Lease under which Developer will assume responsibility for operating the Project Site, as well as the Agency Parcels. Accordingly, except as expressly provided elsewhere in this Agreement, the Agency shall convey the Project Site in its present "as is," "where is" condition with all faults and defects, and shall not prepare or improve the Project Site in any manner whatsoever prior to conveyance to Developer. Developer agrees to accept the Project Site in its condition at the Close of Escrow, subject to the provisions of this Agreement.

(b) Developer has been and will continue to be given the opportunity to investigate the Project Site fully, using experts of its own choosing. In connection with such investigations, the Agency, at no cost to the Agency, shall cooperate reasonably with Developer and shall afford Developer access, upon not less than five (5) days' prior notice to the Agency, and otherwise at all reasonable times, to such non-privileged books and records as the Agency shall have in its possession or control relating to the prior use and/or ownership of the Project Site. Developer acknowledges that no Released Party (as defined below) has made any representation or warranty, express or implied, with respect to the Project Site, and Developer expressly releases the Agency, the City and their respective commissioners, members, supervisors, officers, agents, employees, attorneys, contractors and lenders (individually, a Released Party and collectively "Released Parties") from all Losses arising out of or relating to the condition of any improvements, the size, suitability or fitness of the land, the existence of Hazardous Substances, compliance with any Environmental Laws, or otherwise affecting or relating to the condition, use, value, occupancy or enjoyment of the Project Site. Developer expressly understands that the Project Site is being conveyed in an "as is, where is" condition with all faults and defects. The provisions of this Section 7.1 shall survive the Close of Escrow.

Developer acknowledges that it is familiar with Section 1542 of the California Civil Code which provides as follows:

A GENERAL RELEASE DOES NOT EXTEND TO CLAIMS WHICH THE CREDITOR DOES NOT KNOW OR SUSPECT TO EXIST IN HIS FAVOR AT THE TIME OF EXECUTING THE RELEASE, WHICH IF KNOWN BY HIM MUST HAVE MATERIALLY AFFECTED THIS SETTLEMENT WITH THE DEBTOR.

Developer waives and relinquishes any right or benefit which it has or may have under California Civil Code Section 1542 pertaining to the conveyance of the Project Site.

(c) Subject to Section 7.3, after Close of Escrow, Developer shall comply with all provisions of Environmental Laws applicable to the Project Site and all uses, improvements and appurtenances of and to the Project Site and, as between the Agency and Developer, shall perform all investigations, removal, remedial actions, cleanup and abatement, corrective action or other remediation that may be required under any Environmental Law, the reasonable cost of which shall be deemed an Approved Expense to the extent included in an Approved Budget under the Financing and Revenue Sharing Plan. The Released Parties shall have no responsibility or liability with respect thereto.

(d) The Agency releases Developer, its officers, agents and employees for any Losses suffered by the Agency relating to (i) the Navy's violation of any Environmental Law, or (ii) any Release of a Hazardous Substance, or any pollution, contamination or Hazardous Substance-related nuisance on, under or from the Project Site or Agency Parcels, or any other physical condition on the Project Site or Agency Parcels, to the extent the Release, pollution, contamination, nuisance or physical condition occurred or existed prior to the Close of Escrow on Parcel A-1, except to the extent such violation, Release, pollution, contamination, nuisance or physical condition was caused or exacerbated by Developer, its officers, employees, agents or others for whom Developer is responsible. This release does not extend to obligations assumed by Developer under this Agreement or any of its Attachments, including the Interim Lease, or any rights of entry or any other agreements under which Developer assumes responsibility for environmental or other physical conditions, as to which the Agency reserves its rights to enforce the agreements and to sue Developer.

7.2 Hazardous Substance Indemnification.

(a) Developer shall indemnify, defend and hold harmless the Agency, the City, and their respective commissioners, members, supervisors, officers, agents, employees, attorneys, contractors and lenders (individually, an "Indemnified Party" and collectively, the "Indemnified Parties") from and against any and all claims, liabilities, losses, damage, liens, obligations, interest, injuries, penalties, fines, lawsuits or other proceedings, judgments and awards and costs and expenses (including reasonable attorneys' and consultants' fees and costs and court costs) of whatever kind or nature, known or unknown, contingent or otherwise, present and future, including the reasonable costs to the Indemnified Party of carrying out the terms of any judgment, settlement, consent decree, stipulated judgment or other partial or complete termination of an action or procedure that requires the Indemnified Party to take any action (collectively, "Losses") incurred by or asserted against any Indemnified Party after the Close of Escrow on Parcel A-1 in connection with, arising out of, in response to, or in any manner relating

to (i) Developer's violation of any Environmental Law or (ii) any Release or threatened Release of a Hazardous Substance, or any condition of pollution, contamination or Hazardous Substance-related nuisance on, under or from the Project Site or Agency Parcels to the extent the Release, threatened Release, condition, contamination or nuisance occurred after the Close of Escrow on Parcel A-1 or Parcel B-1, as the case may be, or was caused or exacerbated by Developer, its officers, employees, agents or others for whom Developer is responsible, except, as to any particular Indemnified Party, to the extent such violation, Release, threatened Release, condition, contamination or nuisance was caused by the active negligence or willful misconduct of such Indemnified Party. Developer's obligations under this Section 7.2(a) shall (1) apply regardless of responsibility for passive negligence and the availability of insurance proceeds and (2) survive the expiration or other termination of this Agreement and the Agency's recordation of the Certificate of Completion for the Project Site. Developer specifically acknowledges and agrees that it has an immediate and independent obligation to defend the Indemnified Parties from any claim which actually or potentially falls within the indemnification provision of this Section 7.2(a), even if allegations are or may be groundless, false or fraudulent. Developer's obligation to defend shall arise at the time such claim is tendered to Developer and shall continue at all times thereafter.

(b) The term "Hazardous Substance" means any material, waste, chemical, compound, substance, mixture, or byproduct that is identified, defined, designated, listed, restricted or otherwise regulated under Environmental Laws as a "hazardous constituent," "hazardous substance," "hazardous waste constituent," "infectious waste," "medical waste," "biohazardous waste," "extremely hazardous waste," "pollutant," "toxic pollutant," or "contaminant," or any other formulation intended to classify substances by reason of properties that are deleterious to the environment, natural resources, wildlife or human health or safety, including without limitation, ignitability, infectiousness, corrosiveness, radioactivity, carcinogenicity, toxicity and reproductive toxicity. Hazardous Substance includes without limitation any form of natural gas, petroleum products or any fraction thereof, asbestos, asbestos-containing materials, polychlorinated biphenyls ("PCBs"), PCB-containing materials, and any substance that, due to its characteristics or interaction with one or more other materials, wastes, chemicals, compounds, substances, mixtures or byproducts, damages or threatens to damage the environment, natural resources, wildlife or human health or safety.

(c) The term "Environmental Laws" includes all present and future federal, state and local laws, statutes, rules, regulations, ordinances, standards, directives, interpretations and conditions of approval, all administrative or judicial orders or decrees and all guidelines, permits, license approvals or other entitlements, or rules of common law pertaining to the protection of the environment, natural resources, wildlife, human health or safety, or employee or community right-to-know requirements related to the work being performed under this Agreement. Environmental Laws specifically include the doctrine of environmental justice, under which a community or member thereof may claim that it, he or she has been adversely and disproportionately affected by environmental conditions.

(d) The term "Release" means any accidental or intentional spilling, leaking, pumping, pouring, emitting, emptying, discharging, injecting, escaping, leaching, dumping, or disposing into the air, land, surface water, groundwater or environment (including the

abandonment or discarding of barrels, containers, and other closed receptacles containing any Hazardous Substance).

7.3 Cooperation Regarding Environmental Matters. The Parties have agreed to obtain policies of environmental insurance covering the Project Site and Agency Parcels as specified in Section I of Attachment 7. The Agency will use commercially reasonable efforts to enforce its rights under the Conveyance Agreement and Developer will reasonably cooperate with the Agency in such efforts, including without limitation providing access to the Agency, Navy and their designated representatives and promptly delivering to the Agency non-privileged reports and other pertinent information. The Agency and Developer each will use commercially reasonable efforts to obtain the environmental insurance policy proceeds, and will reasonably cooperate with each other in connection with pursuing claims under the policy.

7.4 Risk of Loss. After Close of Escrow on Parcel A-1 or Parcel B-1, as the case may be, Developer shall bear all risk of loss with respect to the Project Site. Since Developer plans to redevelop the Project Site, the existing improvements thereon do not have significant value for Developer, and therefore damage to or destruction of such improvements will not affect the Parties' rights and obligations under this Agreement, which will continue in full force and effect without any modification; provided, however, that if permitted by applicable law the Agency shall assign to Developer at Closing any and all unexpended insurance proceeds and any uncollected claims and rights under insurance policies covering such loss, if any. However, if solely as a result of an earthquake, flood or other act of God prior to Close of Escrow on Parcel A-1 or Parcel B-1, as the case may be, the estimated cost to construct the Infrastructure, net of any available insurance proceeds, exceeds the construction costs set forth in the then Approved Budget by more than twenty percent (20%), then Developer's sole remedy shall be to terminate this Agreement as to the particular Parcel in question by written notice to the Agency. If an earthquake or other event referenced above occurs, Developer will promptly arrange to have an updated construction estimate prepared by a construction estimator mutually satisfactory to the Parties. The updated construction estimate will reflect any additional costs caused by the earthquake or other event referenced above. The estimator will deliver copies of its estimate to both Parties, each of whom will confirm receipt by written, dated notice to the other. If the updated construction estimate exceeds the "Infrastructure Construction Costs" category of the then Approved Budget (as reasonably allocated between Parcel A-1 and Parcel B-1, if required, based on supporting data acceptable to the Agency and Developer), by at least the percentage specified above, then Developer may terminate this Agreement as to such Parcel(s) by written notice to the Agency within thirty (30) days after receipt of the updated estimate. If the updated estimate does not exceed the "Infrastructure Construction Costs" category by such percentage, or Developer does not elect to terminate, or fails to respond, within the thirty (30) day period, then the Parties' rights and obligations under this Agreement will not be affected and this Agreement shall continue in full force and effect without any modification; provided, however, that if permitted by applicable law, the Agency shall assign to Developer at Closing any and all unexpended insurance proceeds and any uncollected claims and rights under insurance policies covering such loss, if any. Other than the potential assignment of insurance proceeds and claims under this Section, the Agency will have no obligation to repair any improvements on the Project Site nor any liability for their damage or destruction, however caused.

SECTION 8. COOPERATION AND ASSISTANCE

8.1 Interagency Cooperation Agreement. If and when an Interagency Cooperation Agreement is executed and delivered, the Agency shall use commercially reasonable efforts, consistent with the Interagency Cooperation Agreement, to cause the necessary City agencies to timely issue such Authorizations, and perform such other acts as may be required by the Agency and Developer, to permit the development and timely performance contemplated by this Agreement.

8.2 Issuance of Permits.

(a) Developer shall obtain all necessary building permits and subdivision maps and shall make application for such permits directly to the Central Permit Bureau of the City or other applicable City agency.

(b) Prior to Close of Escrow on Parcel A-1, the Agency will use commercially reasonable efforts to cause the City to enact the Subdivision Map Ordinance and Regulations and Developer will subdivide the Project Site to the maximum extent feasible consistent with Attachment 2; provided, however, that at a minimum Developer shall obtain a sufficient subdivision to create legal parcels comprising (i) Parcels A-1 and B-1 (and the remainders of Parcels A and B), (ii) the Agency Housing Parcels, (iii) the Communities Facilities Parcels, (iv) the Open Space and (v) SLC Land (both Post-Exchange and Pre-Exchange). Following Close of Escrow on Parcel A-1, and within the time frames shown on the Schedule of Performance for Infrastructure Development, Developer shall subdivide the Project Site into the Lots shown on Attachment 2. The Agency will reasonably cooperate with Developer in obtaining these subdivisions. Costs associated with subdivisions, other than those required to effect the level of subdivision set forth in clauses (i) through (v) above (which must be accomplished within the caps specified for the Qualified Predevelopment Costs and the Qualified Pre-Agreement Costs in Attachment 25), shall be deemed an Approved Expense to the extent included in an Approved Budget under the Financing and Revenue Sharing Plan.

(c) Developer is advised that the Central Permit Bureau will forward all building permits for the Shipyard to the Agency and the Department of Streets and Mapping will forward all maps for the Shipyard for the Agency's approval of compliance with Redevelopment Requirements and this Agreement. The Agency's review of such permits and maps does not include any review of compliance thereof with the requirements and standards other than as referred to in the Design Review and Document Approval Procedure (DRDAP) for Infrastructure Development and the Agency shall have no obligations or responsibilities for such compliance. Absent manifest error, a signature by an authorized representative of the Agency on the permit, map or other applicable document shall be conclusive evidence that there is no conflict with the Redevelopment Requirements and this Agreement arising out of such permit, map or other applicable document.

8.3 Authorization.

(a) Developer is responsible for obtaining any permit, approval, entitlement, agreement, permit to enter, utility service, subdivision map or other authorization

("Authorization") as may be necessary or desirable to effectuate and implement the contemplated development from any City agency or other governmental agency having or claiming jurisdiction over all or a portion of the Redevelopment Area. The Agency will reasonably cooperate with Developer on request in obtaining these Authorizations, including without limitation executing any such permits, applications or maps to the extent the Agency is required to execute the same as co-applicant or co-permittee, so long as such permits, applications and maps are consistent with this Agreement. Developer will not agree to the imposition of any conditions or restrictions in connection with obtaining any such Authorization if the same would create any obligations on the Agency's part not otherwise contemplated under this Agreement, without the Agency's prior written approval (which may be given or withheld in the Agency's sole discretion). In any event, the Agency will not bear any cost or expense in connection with such permits, applications or maps. All costs of obtaining such permits, other than those relating to matters to be accomplished within the caps specified for the Qualified Predevelopment Costs and the Qualified Pre-Agreement Costs in Attachment 25, shall be deemed an Approved Expense to the extent included in an Approved Budget under the Financing and Revenue Sharing Plan.

(b) Developer, at no cost or expense to the Agency, shall be solely responsible for ensuring that the design and construction of the Infrastructure complies with any and all conditions or restrictions imposed by any City agency or other governmental agency in connection with any Authorization, whether such conditions are to be performed on the Project Site or require the construction of improvements or other actions off the Project Site. Developer shall have the right to appeal or contest any condition in any manner permitted by law; provided, however, that the Agency shall have the right to approve such appeal or contest if the Agency is a co-applicant or co-permittee. Such consent shall not be unreasonably withheld or delayed if Developer can demonstrate to the Agency's reasonable satisfaction that such appeal will not impose any responsibility or liability on the Agency. In all other cases, the Agency shall have the right to withhold its consent in its sole discretion. Any fines, penalties or corrective actions imposed as a result of Developer's failure to comply with the terms and conditions of any such Authorization shall be paid or otherwise discharged by Developer and excluded as an Approved Expense under the Financing and Revenue Sharing Plan, and the Agency shall have no liability, monetary or otherwise, for such fines and penalties.

SECTION 9. INTERIM LEASE

Upon execution of this Agreement, the Agency and Developer shall enter into the Interim Lease requiring Developer to perform certain operation and maintenance obligations on the Project Site and the Agency Parcels.

SECTION 10. AGENCY ADMINISTRATION

The Agency shall from time to time establish a fee for service mechanism for Agency Costs incurred by it pursuant to this Agreement, and by City departments pursuant to the Interagency Cooperation Agreement, in connection with the Agency's or the City's review, approval and oversight in connection with development of the Infrastructure and the Vertical Improvements on the Project Site (which excludes costs associated with development of Vertical Improvements on the Agency Parcels). The Agency will use "commercially reasonable" efforts to recapture all such Agency Costs through the fee-for-service mechanism. Agency Costs in

connection with the Infrastructure shall be included in Approved Budgets or, if there are no Approved Budgets because Developer has elected the alternative set forth in Attachment 26, the Agency shall provide Developer with invoices for Agency Costs each quarter and, if requested, documentation substantiating the amounts claimed. So long as the invoices and substantiating documentation are consistent with the requirements and standards of this Agreement, such invoices shall be binding in the absence of manifest error.

SECTION 11. DEVELOPMENT OF AGENCY HOUSING PARCELS

The Agency shall Commence and Complete Construction on the Agency Housing Parcels in accordance with the Schedule of Performance for the Agency Housing Parcels included in the Vertical DDA. The Agency Housing Parcels and any improvements thereon shall be subject to, and devoted only to the uses permitted by, (a) the Redevelopment Plan, (b) the Amended Design for Development for Vertical Improvements (if agreed upon), (c) the Declaration of Restrictions and (d) this Agreement. The Redevelopment Plan and Declaration of Restrictions will be recorded against both the Project Site and the Agency Parcels. If necessary to create constructive notice to third parties, at the Close of Escrow on Parcel A-1 a memorandum of the Amended Design for Development for Vertical Improvements will also be recorded against both the Project Site and the Agency Parcels, in a form mutually satisfactory to the Agency and Developer.

SECTION 12. DISPUTE RESOLUTION.

12.1 Arbitration/Mediation of Certain Disputes. Notwithstanding the provisions of Section 13, disputes arising under Sections 4.1, 4.2, 4.3, 4.4 and 4.5 of this Agreement (excluding, however, disputes in any way relating to the Agency's failure or refusal to issue a Certificate of Completion) shall be subject to mediation and then to arbitration under Section 12.2 (collectively, "Construction Disputes"). All disputes that are not Construction Disputes will be subject to litigation, except to the extent another form of dispute resolution is specifically provided for in a particular Attachment, *e.g.*, as for Budget Disputes under Attachment 25.

12.2 Construction Disputes.

12.2.1 Good Faith Negotiation by Parties. The Parties shall attempt to resolve, through good faith negotiation among themselves, any Construction Dispute subject to this Section 12 for a period of ten (10) days after the Construction Dispute is raised by any Party in a written notice to the other Party. Each Party shall be represented in such negotiations by one or more representatives with decision making and settlement authority sufficient to resolve the Construction Dispute, subject to approval of the Party's governing body, where required.

12.2.2 Mediation and Arbitration. Any Construction Dispute that cannot be resolved by the Parties during such ten (10) day good faith negotiation period shall be submitted first to mediation within five (5) days after conclusion of the good faith negotiation period described in Section 12.2.2.

(a) The mediator ("Mediator") will be the first available Mediator from a list of at least three (3) pre-approved Mediators to be agreed upon by the Parties as a

condition to Closing, starting with the first named Mediator and continuing to cycle through the list as Mediators are required, provided that no Mediator will mediate consecutive disputes. If none of the Mediators listed is able or willing to serve, a single neutral Mediator shall be appointed by JAMS/Endispute in San Francisco, California. The Mediator appointed must have at least ten (10) years of experience in resolving disputes similar to the dispute at issue.

(b) The mediation shall be conducted according to the rules established by JAMS/Endispute; provided that, the mediation must be completed within thirty (30) days after the Mediator is appointed.

(c) If a dispute has not been resolved through an agreement in principle among the Parties within the period specified in Section 12.2(b) above, the matter will be submitted to arbitration.

(d) The arbitrator ("Arbiter") will be the first available arbitrator from a list of at least three (3) pre-approved Arbiters to be agreed upon by the Parties as a condition to Closing, starting with the first named Arbiter and continuing to cycle through the list as Arbiters are required, provided that no Arbiter will arbitrate consecutive disputes. If none of the Arbiters listed is able or willing to serve, a single neutral Arbiter shall be appointed by JAMS/Endispute in San Francisco, California. The Arbiter appointed must have at least ten (10) years of experience in resolving disputes similar to the dispute at issue.

(e) The arbitration shall be conducted according to the rules established by JAMS/Endispute. Judgment upon the Arbiter's decision may be entered in any court of competent jurisdiction.

(f) Initially, each Party will advance fifty percent (50%) of the fees and costs of the Mediator and the Arbiter, if any. The non-prevailing Party in the arbitration shall pay the Mediator's and Arbiter's fees and costs.

(g) The provisions of this Section 12 shall constitute the sole and exclusive provisions for the resolution of any and all Construction Disputes subject to this Section 12, whether arising before or after the Effective Date.

12.3 Acknowledgment.

NOTICE: BY INITIALING IN THE SPACE BELOW YOU ARE AGREEING TO HAVE ANY DISPUTE ARISING OUT OF THE MATTERS INCLUDED IN SECTION 12.2 DECIDED BY NEUTRAL ARBITRATION AS PROVIDED BY CALIFORNIA LAW AND YOU ARE GIVING UP ANY RIGHTS YOU MIGHT POSSESS TO HAVE THE DISPUTE LITIGATED IN A COURT OR JURY TRIAL. BY INITIALING IN THE SPACE BELOW YOU ARE GIVING UP YOUR JUDICIAL RIGHTS TO DISCOVERY AND APPEAL UNLESS THOSE RIGHTS ARE SPECIFICALLY INCLUDED IN SECTION 12.2. IF YOU REFUSE TO SUBMIT TO ARBITRATION AFTER AGREEING TO THIS PROVISION YOU MAY BE COMPELLED TO ARBITRATE UNDER THE AUTHORITY OF THE CALIFORNIA CODE OF CIVIL PROCEDURE. YOUR AGREEMENT TO THIS PROVISION IS VOLUNTARY. WE HAVE READ AND UNDERSTAND THE FOREGOING AND

AGREE TO SUBMIT DISPUTES ARISING OUT THE MATTERS INCLUDED IN SECTION 12.2 TO NEUTRAL ARBITRATION IN ACCORDANCE WITH THOSE SECTIONS.

Agreed to and accepted by: Agency: MR Developer: DM

12.4 Proceeding Pending Resolution of a Dispute. Pending agreement or other resolution of any Construction Dispute, or other dispute hereunder, Developer will proceed in accordance with (i) elements of this Agreement that are not subject to dispute and (ii) all elements of this Agreement that are subject to dispute in accordance with Developer's positions, pending resolution of the dispute, unless the Agency in its sole and absolute discretion directs otherwise; provided, however, that if proceeding with Developer's position in any Construction Dispute is infeasible because the Construction Dispute involves the Agency's disapproval or conditional approval of Construction Documents, or an alleged design defect or code violation that could result in the Infrastructure being installed having to be demolished and replaced, then Developer may elect not to proceed until such Construction Dispute is resolved. If Developer proceeds pending resolution of a dispute, then as part of the ultimate agreement or resolution between Developer and the Agency they shall prepare a written reconciliation of the amounts paid by Developer and the amounts that should have been paid in accordance with the final agreement or resolution, and Developer and the Agency shall then make any necessary adjustments between them based on the reconciliation.

SECTION 13. DEFAULTS AND REMEDIES

13.1 General.

(a) Except as otherwise expressly provided in this Agreement, in the event of any default in or breach of this Agreement by either Developer or the Agency, the non-defaulting Party may deliver a notice of default to the other Party regarding such default or breach. The notice of default shall state with reasonable specificity the nature of the alleged default, the provisions under which the default is claimed to arise and the manner in which the failure of performance may be satisfactorily cured. Upon receipt of such notice of default, unless a shorter time is provided for in this Agreement, either Developer or the Agency, as applicable, shall commence within a reasonable time not to exceed sixty (60) days to cure or remedy such default or breach, and shall thereafter pursue such cure or remedy diligently to completion.

(b) Upon delivery of a notice of default, the Agency and Developer shall promptly meet to discuss the alleged default or breach and the manner in which the defaulting Party can cure or remedy the same so as to satisfy the aggrieved Party's concerns. Developer and the Agency shall continue meeting regularly, discussing, investigating and considering alternatives during the cure period permitted under this Agreement for the particular default. If, at any time, the aggrieved Party no longer holds the view that the other Party is in default the aggrieved Party shall issue a written acknowledgement of the other Party's cure or remedy of the matter which was the subject of the notice of default.

If (i) remedial action is not diligently taken or pursued, or the default or breach shall not be cured or remedied within the cure period permitted under this Agreement or

(ii) either Developer or the Agency shall refuse to meet and discuss as described above, then the aggrieved Party may institute such proceedings (except as otherwise provided in this Agreement) as may be necessary or desirable in its opinion to cure such default or breach, including without limitation, proceedings to compel specific performance by the Party in default or breach of its obligations. Nothing in this Section 13.1(b) shall require a Party to postpone instituting any injunctive proceeding if it believes in good faith that such postponement will cause irreparable harm to such Party.

(c) Notwithstanding any other provision herein to the contrary, neither Developer nor any Transferee shall be deemed in default with respect to the portion of the Redevelopment Area owned by Developer or Transferee so long as Developer or Transferee performs all of its obligations under this Agreement in accordance with the provisions of this Agreement; provided, however, that nothing in this Section 13 shall be deemed to supersede or preclude the Agency's, City's or any City agencies' rights and remedies under any permit, approval, subdivision map, or other entitlement granted for the development and use of the Project Site, or with respect to any other project, which rights and remedies shall be in addition to the rights and remedies under this Section 13.

13.2 Default by Developer or Guarantor(s). The occurrence of any one of the following events or circumstances shall constitute an "Event of Default" by Developer under this Agreement:

(a) Developer causes or permits a Transfer not permitted under this Agreement, or a Significant Change, to occur;

(b) Developer allows any other person or entity (except Developer's authorized representatives) to occupy or use all or any part of the Project Site in violation of this Agreement, and such event or condition shall not have been cured within thirty (30) days following Developer's receipt of written notice thereof from the Agency;

(c) Developer fails to pay real estate taxes or assessments on the Project Site when due or places any mortgages, encumbrances or liens upon the Project Site or improvements or any part thereof in violation of this Agreement, and such event or condition shall not have been cured within thirty (30) days following Developer's receipt of written notice thereof from the Agency, subject, as to encumbrances and liens, to Developer's right to contest the validity or amount of any tax, assessment, encumbrance or lien and to pursue any remedies associated with such contest; provided, however, that such contest and pursuit of remedies does not subject the Project Site, the Horizontal Improvements or any portion of them to sale or forfeiture, nor impair any of Developer's obligations under this Agreement;

(d) Developer fails to Commence Construction or to Complete Construction of the Infrastructure within the times set forth in the Schedule of Performance for Infrastructure Development, or Abandons or substantially suspends construction of the Infrastructure for more than ten (10) consecutive days, or a total of thirty (30) days, and such failure, Abandonment or suspension continues for a period of thirty (30) days following Developer's receipt of written notice thereof from the Agency as to an Abandonment, suspension or failure to Commence Construction or to Complete Construction;

(e) Developer causes or permits, within its reasonable control, a default as defined in and occurring under any agreement attached hereto or referenced herein, including without limitation the Interim Lease and ENA, and fails to cure the same in accordance with such other agreement; provided, however, that the Agency's remedies for a default under such other agreement between the Agency and Developer shall be limited to the remedies set forth therein, but such restriction shall not impair the Agency's remedies under this Agreement;

(f) Developer fails to pay any amount required to be paid hereunder, and such failure continues for a period of ten (10) Business Days following Developer's receipt of written notice thereof from the Agency;

(g) Developer does not accept conveyance of either Parcel A-1 or Parcel B-1 in violation of this Agreement upon tender by the Agency pursuant to this Agreement, and such failure continues for a period of three (3) Business Days following Developer's receipt of written notice thereof from the Agency;

(h) Developer is in default under the Prevailing Wage Requirements, the Card Check Agreement, the Minimum Compensation Policy, the Healthcare Accountability Policy, the Equal Benefits Policy or the Equal Opportunity Program and Community Benefits Provided by Developer (attached hereto as Attachments 13, 14, 15, 16, 17 and 24 respectively, and fails to cure the same in accordance with such other agreements), subject, however, to any rights to cure and the Agency's remedies for any default under the Equal Opportunity Program and Community Benefits Provided by Developer;

(i) Developer fails to obtain appropriate Authorizations for the Infrastructure to be constructed on the Project Site within the periods of time specified in this Agreement and the Schedule of Performance for Infrastructure Development, and such failure continues for a period of thirty (30) days following Developer's receipt of written notice thereof from the Agency;

(j) Developer does not submit to the Agency all Construction Documents as required by this Agreement within the periods of time specified in this Agreement and the Schedule of Performance for Infrastructure Development, and such failure continues for a period of thirty (30) days following Developer's receipt of written notice thereof from the Agency;

(k) Developer shall not have certified in writing to the Agency that Developer is ready, willing and able in accordance with this Agreement to Commence Construction of the Infrastructure by the time set forth in the Schedule of Performance for Infrastructure Development, and such failure shall continue for a period of ten (10) Business Days following receipt of written notice thereof from the Agency;

(l) Developer defaults in the performance of or violates any covenant, or any part thereof, set forth in the Quitclaim Deed, and such default or violation continues for a period of thirty (30) days following Developer's receipt of written notice thereof from the Agency;

(m) Developer fails to perform any other agreements or obligations on Developer's part to be performed under this Agreement, and such failure continues for the period of time for any cure or the expiration of any grace period specified in this Agreement therefor, or if no such time or grace period is specified, within sixty (60) days after Developer's receipt of

written notice thereof from the Agency, or in the case of a default that is curable but is not susceptible of cure within sixty (60) days, Developer fails promptly to commence to cure such default and thereafter diligently to prosecute such cure to completion within a reasonable time, but in no event to exceed one hundred and twenty (120) days; or

(n) Either or both Guarantor(s) default under the Guaranty.

13.3 Agency's Remedies.

(a) **Termination.** If there is an Event of Default by Developer, the Agency may terminate this Agreement and record a notice of termination as set forth in Section 6.9.

(b) **Liquidated Damages.** THE AGENCY AND DEVELOPER ACKNOWLEDGE AND AGREE THAT IT IS DIFFICULT OR IMPOSSIBLE TO DETERMINE WITH PRECISION THE AMOUNT OF DAMAGES THAT WOULD OR MIGHT BE INCURRED BY THE AGENCY AS A RESULT OF DEVELOPER'S FAILURE TO ACHIEVE CLOSE OF ESCROW, COMMENCE CONSTRUCTION AND COMPLETE CONSTRUCTION BY THE DATES SPECIFIED IN THE SCHEDULE OF PERFORMANCE FOR INFRASTRUCTURE DEVELOPMENT, AS THE SAME MAY BE EXTENDED BY UNAVOIDABLE DELAY OR OTHERWISE AS PERMITTED BY THIS AGREEMENT. THEREFORE, AS AN ALTERNATIVE TO TERMINATION, THE AGENCY IN ITS SOLE AND ABSOLUTE DISCRETION MAY ASSESS, AND DEVELOPER SHALL PAY WITHIN TEN (10) DAYS AFTER DELIVERY OF AN INVOICE FROM THE AGENCY (OR SOONER IF REQUIRED BY THIS AGREEMENT), THE PER DIEM AMOUNT SPECIFIED BELOW FOR EACH DAY CLOSE OF ESCROW, COMMENCEMENT OF CONSTRUCTION OR COMPLETION OF CONSTRUCTION, OR ANY OF THEM, ARE DELAYED BY REASON OF AN EVENT OF DEFAULT BY DEVELOPER OR OTHERS FOR WHOM IT IS RESPONSIBLE BEYOND THE DATE SPECIFIED IN THE SCHEDULE OF PERFORMANCE FOR INFRASTRUCTURE DEVELOPMENT, TO THE EXTENT NOT EXCUSED BY UNAVOIDABLE DELAY, AT THE RATE OF EIGHTEEN THOUSAND DOLLARS (\$18,000.00) PER DAY FOR EACH DAY OF DELAY. THE PARTIES SPECIFICALLY ACKNOWLEDGE AND AGREE THAT (1) THE AGENCY WILL BE DAMAGED BY DEVELOPER'S FAILURE TO MEET ITS OBLIGATIONS UNDER THE SCHEDULE OF PERFORMANCE FOR INFRASTRUCTURE DEVELOPMENT, (2) ANY SUMS PAYABLE UNDER THIS SECTION ARE IN THE NATURE OF LIQUIDATED DAMAGES AND NOT A PENALTY AND (3) SUCH PAYMENT REPRESENTS A REASONABLE ESTIMATE OF FAIR COMPENSATION FOR THE LOSSES THAT MAY REASONABLY BE ANTICIPATED FROM SUCH FAILURE. BY PLACING THEIR INITIAL IN THE SPACE BELOW, THE PARTIES SPECIFICALLY ACKNOWLEDGE AND ACCEPT THE PROVISIONS OF THIS SECTION. THE AGENCY'S ELECTION TO ASSESS LIQUIDATED DAMAGES UNDER THIS SECTION SHALL NOT IN ANY WAY IMPAIR THE AGENCY'S ABILITY TO TERMINATE THIS AGREEMENT BECAUSE OF AN EVENT OF DEFAULT BY DEVELOPER. THE AGENCY MAY EXERCISE SUCH ELECTION BEFORE OR AFTER ASSESSING LIQUIDATED DAMAGES, BUT THE AGENCY'S RIGHT TO ASSESS LIQUIDATED DAMAGES WILL TERMINATE CONCURRENTLY WITH TERMINATION OF THIS AGREEMENT. DEVELOPER'S LIABILITY FOR LIQUIDATED DAMAGES UNDER THIS SECTION 13.3(b) WILL NOT

EXCEED TWENTY-SIX MILLION DOLLARS (\$26,000,000.00); PROVIDED THAT, DEVELOPER MAY FURTHER LIMIT ITS LIQUIDATED DAMAGES BY GIVING NOTICE TO THE AGENCY THAT IT IS QUITCLAIMING ALL OF ITS RIGHT, TITLE AND INTEREST IN AND TO PARCELS A-1 AND B-1, AS WELL AS TO ANY OTHER PORTION OF SHIPYARD. LIQUIDATED DAMAGES WILL THEN BE ASSESSED AT THE RATE OF SIX MILLION FIVE HUNDRED THOUSAND DOLLARS (\$6,500,000.00) PER YEAR FOR ONE (1) YEAR AFTER THE AGENCY RECEIVES SUCH NOTICE AND A QUITCLAIM DEED OR OTHER DOCUMENT REASONABLY ACCEPTABLE TO DEVELOPER AND THE AGENCY EVIDENCING DEVELOPER'S QUITCLAIM. NEITHER SUCH NOTICE, NOR THE PAYMENT OF LIQUIDATED DAMAGES UNDER THIS SECTION 13.3(b), WILL RELIEVE DEVELOPER OF ANY INDEMNITY OR OTHER OBLIGATIONS THAT ARE INTENDED TO SURVIVE EXPIRATION OF THIS AGREEMENT.

 Developer

 Agency

(c) **Conveyance of Title.** As additional security and to facilitate and implement the Agency's rights under the Quitclaim Deed and this Section in case of an Event of Default by Developer after conveyance of either Parcel A-1 or Parcel B-1, and as a condition precedent to the Agency's obligation to convey either Parcel A-1 or B-1 to Developer, Developer shall have executed and delivered to the Title Company a recordable grant deed in the form attached hereto as Attachment 6 (the "Reversionary Grant Deed") conveying title to the Project Site (or to Parcel A-1, if the Event of Default by Developer is after the conveyance of Parcel A-1, but before the conveyance of Parcel B-1) from Developer to the Agency. The Reversionary Grant Deed will be delivered with irrevocable instructions from Developer to the Title Company, reasonably acceptable to the Agency, directing the Title Company to comply with the Agency's direction to record the Reversionary Grant Deed upon the Agency's written notice that Developer has committed an Event of Default. In the event the Agency believes that the Agency is entitled to exercise the Agency's option to cause title to the Project Site (or to Parcel A-1, as the case may be) to vest in the Agency, then the Agency, without limiting its remedies under this Agreement, may direct the Title Company to record the appropriate Reversionary Grant Deed and to notify Developer of such recordation. The Title Company's recordation of the Reversionary Grant Deed shall not affect in any manner Developer's rights (whether before or after such recordation) to exercise any and all remedies available to Developer to contest the Agency's rights to cause the recordation of the Reversionary Grant Deed or from otherwise asserting some right, title or interest in or to the Project Site (or to Parcel A-1, if applicable). Provided that Developer has received notice as provided herein, Developer must bring any action contesting the Agency's right to record the Reversionary Grant Deed within sixty (60) days following recordation of the Reversionary Grant Deed, or Developer shall be precluded from challenging the Agency's action. If not used, the Agency will return the Reversionary Grant Deed to Developer within two (2) Business Days after recordation of the final Certificate of Completion for the Project Site and, in any event, will not be entitled to record the Reversionary Grant Deed after recordation of the final Certificate of Completion for the Project Site.

(d) **Specific Performance.** Subject to Section 13.8 below, the Agency shall have the right to institute an action for specific performance of this Agreement or of the Quitclaim Deed, including without limitation the right to institute any action for specific performance of

Developer's obligations under this Agreement or the Quitclaim Deed to construct the Infrastructure.

(e) **Other Remedies.** The remedies provided for herein are in addition to and not in limitation of other remedies, including without limitation, (i) those provided in the Quitclaim Deed and elsewhere for violation of the covenants set forth in Section 19; (ii) the remedies set forth in the Equal Opportunity Program and (iii) the remedies set forth in the Prevailing Wage Requirements, the Card Check Agreement, the Minimum Compensation Policy, the Healthcare Accountability Policy and the Equal Benefits Policy.

13.4 Default by Agency.

The occurrence of any one of the following events or circumstances shall constitute an Event of Default by the Agency under this Agreement:

(a) The Agency fails to convey Parcel A-1 or Parcel B-1, as the case may be, in violation of this Agreement, and such failure continues for a period of ten (10) Business Days following the Agency's receipt of written notice thereof from Developer; or

(b) The Agency fails to perform any other agreements or obligations on the Agency's part to be performed under this Agreement, and such failure continues for the period of time for any cure or the expiration of any grace period specified in this Agreement therefor, or if no such time or grace period is specified, within sixty (60) days after the Agency's receipt of written notice thereof from Developer, or, in the case of a default that is curable but is not susceptible of cure within sixty (60) days, if the Agency fails promptly to commence to cure such default and thereafter diligently to prosecute such cure to completion within a reasonable time, but in no event to exceed one hundred and twenty (120) days.

13.5 Developer's Remedies. For an Event of Default by the Agency hereunder, Developer shall have the following remedies:

(a) **Limitation on Damages.** The Agency shall not be liable to Developer for monetary damages caused by any Event of Default by the Agency, or required to expend money to cure any Event of Default by the Agency, except as provided in Section 13.5(d) below, subject to the limitation contained in Section 13.8 below.

(b) **Specific Performance.** Subject to Section 13.8 below, Developer shall have the right to institute an action for specific performance of this Agreement.

(c) **Other Remedies.** Subject to Sections 13.1, 13.5(a), (b) and (d), Developer shall be entitled to exercise all other remedies permitted by law.

(d) **Agency Liability.** The Agency shall be liable for reasonable attorneys' fees and costs and other payments allowed under Section 22.7 incurred by Developer if Developer prevails in enforcing its rights hereunder, and is entitled to the same under Section 22.7. In addition, if all conditions to the Close of Escrow have been satisfied or waived in accordance with this Agreement, but the Agency willfully fails to transfer either Parcel A-1 or B-1 to Developer in violation of this Agreement (and the Agency fails to cure such Event of Default

within the period permitted in Section 13.4(a)), then Developer may terminate this Agreement and pursue the Agency in litigation for recovery of the amount of Developer's unpaid Qualified Predevelopment Costs and Qualified Pre-Agreement Costs (as defined in Attachment 25), to the extent that Developer proves it could have recovered the same if the Agency had complied with its obligation to convey Parcel A-1 or Parcel B-1, as the case may be; provided, however, that (i) in no event will the Agency be liable for monetary damages in excess of Twenty Million Dollars (\$20,000,000.00) and (ii) Developer may recover any damages awarded only from the net proceeds resulting from a Transfer of the Agency's interest in Parcel A-1 or Parcel B-1, as the case may be, and not from any of the Agency's other assets. Except as expressly set forth in this Section 13.5(d) and in Section 22.7, the Agency shall have no liability whatsoever for monetary damages, and in no event will the Agency be liable for lost opportunities, lost profits or other damages of a consequential nature.

13.6 Rights and Remedies Cumulative. Except with respect to any provision in this Agreement to the contrary, the rights and remedies of the Parties, whether provided by law or this Agreement, shall be cumulative, and the exercise by either Party of any one or more of such remedies shall not preclude the exercise by it, at the same or different times, of any other remedies for the same Event of Default by the other Party.

13.7 No Implied Waiver. No waiver made by a waiving Party with respect to the performance or manner or time thereof (including an extension of time for performance) of any obligations of the other Party, or of any condition to the waiving Party's own obligations, shall be considered a waiver of the waiving Party's rights with respect to any obligation of the other Party or any condition to the waiving Party's own obligations beyond those expressly waived in writing.

13.8 Limitation on Liability. No commissioners, members, supervisors, officers, agents or employees of the Agency or City (or of their successors or assigns) shall be personally liable to Developer, nor shall any officers, directors, shareholders, agents or employees of Developer (or of its successor or assigns) be personally liable to the Agency in the event of any Event of Default under this Agreement by the Agency or Developer or for any amount which may become due to Developer or the Agency or any obligations under this Agreement (except as expressly provided in the Guaranty).

13.9 Criteria For Specific Performance. Both Parties recognize that the obligations of the Agency to convey Parcels A-1 and B-1, and of Developer to construct the Infrastructure and to Transfer the Lots pursuant to this Agreement, are special, unique and of extraordinary character, and if either Party fails to perform such obligations, the other Party will not have an adequate remedy at law. Under such circumstances, either Party, in addition to any other rights which it may have, shall be entitled to injunctive relief to enforce any such obligations. In the event proceedings are brought in equity to enforce such obligations, neither Party shall raise as a defense that there is an adequate remedy at law as to such obligations.

SECTION 14. TRANSFERS OF OBLIGATIONS TO COMPLETE IMPROVEMENTS

14.1 The Agency's Right to Transfer. The Agency shall have the right to Transfer all or any portion of the Redevelopment Area or its rights and obligations under this Agreement without Developer's consent.

14.2 Developer's Right to Transfer. Developer shall not assign this Agreement or Transfer all or any portion of the Project Site to any Person during the Term of this Agreement, except for sales thereof in accordance with Section 15. This restriction does not apply to subsequent Transferees receiving portions of the Project Site under Section 15 (all of whom will be subject to the Vertical DDA); provided, however, that this restriction will apply to Developer if any portion of the Project Site reverts to Developer following a sale under Section 15.

SECTION 15. TRANSFER OF LOTS

The Parties contemplate that the Lots will be sold to Affiliates of Developer, including without limitation Developer/Community Builder Ventures, Community Builders and Qualified Buyers to construct Vertical Improvements on each of the Lots. Developer and the Agency each has a financial interest in the purchase price for the Lots as described in the Financing and Revenue Sharing Plan, and the Agency has other interests relating to the identity, characteristics and qualifications of the buyers of the Lots. The following conditions apply to all sales.

15.1 Minimum Purchase Price. The "Minimum Purchase Price" for each Lot will be set forth on a schedule to the Preliminary Budget and Project Pro Forma attached as Exhibit A to the Financing and Revenue Sharing Plan attached as Attachment 25. The Minimum Purchase Price assumes a full cash purchase price to seller. Unless both Parties mutually agree otherwise, in their respective sole discretion, each Lot will be sold for at least the Minimum Purchase Price designated for that Lot, on a full cash purchase price basis, in accordance with this Section 15.

15.2 Restricted Use Appraisal Report. After issuance of a Certificate of Completion for a particular Lot (or prior thereto, if each Party so agrees, in its sole discretion), both Parties may elect to sell the Lot under Section 15.3. However, if one Party desires to sell the Lot and the other Party does not agree within fifteen (15) days after receipt of a written request to sell, then the Party desiring to sell the Lot may initiate a "Restricted Use Appraisal Report." The Restricted Use Appraisal Report will be performed by an Appraiser mutually acceptable to the Agency and Developer. If the Agency and Developer cannot agree on a mutually acceptable Appraiser within ten (10) days after the initiating Party delivers written notice to the other Party of its election to proceed with a Restricted Use Appraisal Report, then the Appraiser will be the first available Appraiser from a list of at least five (5) pre-approved Appraisers to be agreed upon by the Parties as a condition to Closing, starting with the first named Appraiser and continuing to cycle through the list as Appraisers are required, provided that no Appraiser will appraise more than three (3) consecutive Lots. If none of the Appraisers listed is able or willing to serve, then within ten (10) days after either Party accurately informs the other in writing that no listed Appraiser is able or willing to serve, each Party will prepare a list of three (3) Appraisers acceptable to that Party and exchange its list with the other Party. Within ten (10) days after receipt of the other Party's list, each Party will strike two (2) names and return the modified list. The Parties will then promptly apply to the Presiding Judge of the Superior Court of the City and

County of San Francisco to select the Appraiser from the two names remaining, and his or her decision will conclusively determine the Appraiser. The Restricted Use Appraisal Report will determine whether the Lot could be sold for at least the Minimum Purchase Price designated for that Lot, assuming it is marketed in accordance with this Section 15. The initiating Party will instruct the Appraiser to (i) prepare a written Restricted Use Appraisal Report and deliver it to both Parties within thirty (30) days after request, (ii) include comparables supporting the Appraiser's conclusion, (iii) take into account the benefits accruing to the Lot under the Vertical DDA and the obligations imposed on the Lot under the Vertical DDA, including without limitation the Schedule of Performance for Vertical Improvements and (iv) consider the carrying costs required if Vertical Improvements on the Lot are not able to be developed promptly after the purchase closes because of market conditions (subject to buyer's compliance with the Schedule of Performance for Vertical Improvements). However, the Restricted Use Appraisal Report will not be as comprehensive as the Complete Appraisal contemplated in Section 15.3 since the intent is not to determine the Fair Market Value for the Lot, but rather whether the Lot could be sold for at least the Minimum Purchase Price under the criteria specified in this Section 15.2. Each Party will confirm its receipt of the Restricted Use Appraisal Report by written, dated notice to the other Party. The cost of the Restricted Use Appraisal Report will be borne by the initiating Party unless the Restricted Use Appraisal Report concludes that the Lot could be sold for the Minimum Purchase Price, in which event the other Party will bear the cost of the Restricted Use Appraisal Report.

15.3 Affiliate Lot.

(a) If the Lot to be sold is an [?]Affiliate Lot and both Parties elect to sell, they will confirm that election in a dated writing. An Affiliate of Developer (to be designated by Developer) may elect to buy the Affiliate Lot by delivering written notice to the Agency within fifteen (15) days after the confirmation date. If the designated Affiliate of Developer does so elect, the Parties will initiate a Complete Appraisal under Section 15.3(b). If the designated Affiliate of Developer does not so elect within the fifteen (15) day period, the Parties will initiate a Third-Party Sale under Section 15.3(c). If the Lot to be sold is an Affiliate Lot and Developer initiated a Restricted Use Appraisal Report which concluded that the Affiliate Lot could be sold for at least the Minimum Purchase Price, then an Affiliate of Developer may elect to buy the Affiliate Lot by delivering written notice to the Agency within fifteen (15) days after Developer receives the Restricted Use Appraisal Report. If the designated Affiliate of Developer does so elect, the Parties will initiate a Complete Appraisal under Section 15.3(b). If the designated Affiliate of Developer does not so elect within the fifteen (15) day period, the Parties will initiate a Third-Party Sale under Section 15.3(c). If the Lot to be sold is an Affiliate Lot and the Agency initiated a Restricted Use Appraisal Report which concluded that the Affiliate Lot could be sold for at least the Minimum Purchase Price, then an Affiliate of Developer may elect to buy the Affiliate Lot by delivering written notice to the Agency within thirty (30) days after Developer receives the Restricted Use Appraisal Report. If the designated Affiliate of Developer does so elect, the Parties will initiate a Complete Appraisal under Section 15.3(b). If the designated Affiliate of Developer does not so elect within the thirty (30) day period, the Parties will initiate a Third-Party Sale under Section 15.3(c).

(b) **Complete Appraisal and Sale to Affiliate of Developer.** If the Parties are proceeding under this Section 15.3(b), they will promptly initiate a "Complete Appraisal" of the

Affiliate Lot in question by the same Appraiser, if any, who performed the Restricted Use Appraisal Report. If there was no Restricted Use Appraisal Report, or if the Appraiser who performed the Restricted Use Appraisal Report is not available, the Appraiser for the Complete Appraisal will be selected using the same procedure as set forth in Section 15.2, including the requirement that no Appraiser will appraise more than three (3) consecutive Lots; provided, however, that the ten (10) day period for the Parties to agree on a mutually acceptable Appraiser will be measured from the date the designated Affiliate of Developer delivers written notice of its election to purchase, rather than the date the initiating Party delivers written notice of its election to proceed with a Restricted Use Appraisal Report. The Parties will instruct the Appraiser to prepare a Complete Appraisal and deliver copies to both Parties within sixty (60) days after request. The Complete Appraisal will address all of the items in Section 15.2 above, and will also determine the Fair Market Value of the Affiliate Lot in question. Each Party will confirm its receipt of the Complete Appraisal by written, dated notice to the other Party. The Appraiser's determination of Fair Market Value will be conclusive on both Parties, and so long as the Fair Market Value is at least the Minimum Purchase Price, the designated Affiliate of Developer will buy the Affiliate Lot "as is," "where is" from Developer for the Fair Market Value, payable in full cash to seller at closing. This transaction must close within thirty (30) days after the date of the last Party's confirmation of receipt of the Complete Appraisal through an escrow with the Title Company, and in accordance with an agreement between the Developer and its Affiliate in a form mutually acceptable to the Agency and the Developer Affiliate (the "Affiliate Purchase and Sale Agreement"). If the Complete Appraisal determines that the Fair Market Value is less than the Minimum Purchase Price, then the Affiliate Lot will not be sold at that point, unless the Parties mutually agree otherwise, in each Party's sole discretion. The Parties will bear the cost of the Complete Appraisal in equal shares.

(c) **Third-Party Sale.** If the Parties are proceeding under this Section 15.3(c), they will promptly initiate a marketing program for the Lot in question through a Broker mutually acceptable to both of them. If the Parties cannot agree on a mutually acceptable Broker within ten (10) days after the receipt by either Party of a written proposal of a Broker by the other Party, then the Broker will be the first available Broker from a list of at least five (5) pre-approved Brokers to be agreed upon by the Parties as a condition to Closing, starting with the first named Broker and continuing to cycle through the list as Brokers are required, provided that no Broker shall represent Developer in more than three (3) consecutive sales of Affiliate Lots. If none of the Brokers listed is able or willing to serve, then within ten (10) days after either Party accurately informs the other in writing that no listed Broker is able or willing to serve, each Party will prepare a list of three (3) Brokers acceptable to that Party and exchange its list with the other Party. Within ten (10) days after receipt of the other Party's list, each Party will strike two (2) names and return the modified list. The Broker will be one (1) of the two (2) names remaining on the list, with each Party's final selection to be chosen in turn. The initial selection will be determined by a coin toss. Developer will retain the Broker selected through a listing agreement in a form mutually acceptable to the Agency, Developer and the Broker (the "Real Estate Brokerage Agreement"). The "Marketing Period" during which the Lot will be actively marketed will be six (6) months. If during the Marketing Period a Qualified Buyer offers to buy the Lot "as is," "where is" for Fair Market Value (but in no event less than the Minimum Purchase Price), payable in full cash to seller at closing, then Developer will enter into a purchase and sale agreement with the Qualified Buyer in a form mutually acceptable to the Agency, Developer and the Qualified Buyer (the "Third-Party Purchase and Sale Agreement"),

and upon request Developer will quitclaim any rights to such Lot arising under this Agreement, if the Lot is an Affiliate Lot. If (i) no Qualified Buyer offers to buy the Affiliate Lot during the Marketing Period for Fair Market Value (but in no event less than the Minimum Purchase Price), (ii) the Parties and the Qualified Buyer cannot agree on the form of Third-Party Purchase and Sale Agreement or (iii) any such Qualified Buyer defaults under the Third-Party Purchase and Sale Agreement, then the Affiliate Lot in question will not be sold to the specified Qualified Buyer and instead will again be available for purchase by an Affiliate of Developer under this Section 15; provided, however, that if either Party so elects within ten (10) days after notice of a default by the Qualified Buyer for Developer to pursue specific performance against the Qualified Buyer, then Developer will initiate and diligently prosecute an action for specific performance. The initiating Party will bear the reasonable cost of the specific performance action if it is unsuccessful, but if it is successful then both Parties will bear the cost in equal shares.

15.4 Community Builder Lot. If the Lot to be sold is a Community Builder Lot, and if Developer and a Community Builder have entered into a joint venture or other arrangement consistent with Section 15.6 (a “Developer/Community Builder Venture”) within ten (10) days following (a) confirmation of the Parties’ mutual agreement to sell the Lot in question or (b) the date Developer receives the Restricted Use Appraisal Report, as the case may be (the “Joint Venture Election Date”), then the Developer/Community Builder Venture will have the same rights, and be subject to the same obligations, in connection with the transfer of a Community Builder Lot as an Affiliate of Developer has in connection with an Affiliate Lot. If the Lot to be sold is a Community Builder Lot, and if Developer and a Community Builder have not entered into a joint venture or other arrangement consistent with Section 15.6 on or before the Joint Venture Election Date and if either (i) both Parties elected to sell or (ii) the Restricted Use Appraisal Report, if any, concluded that the Community Builder Lot could be sold for at least the Minimum Purchase Price designated for that Lot, assuming it is marketed consistent with the marketing procedures for Sales of Community Builder Lots included in Section 15.6, then the Community Builder Lot will be sold under this Section 15.4. Developer will market the Community Builder Lot to Community Builders consistent with Section 15.6. If a Community Builder offers to buy the Community Builder Lot “as is,” “where is” for the Fair Market Value (but in no event less than the Minimum Purchase Price), payable in full cash to seller at closing, then Developer will enter into a purchase and sale agreement with the Community Builder in a form mutually acceptable to the Agency, Developer and the Community Builder (the “Community Builder Purchase and Sale Agreement”). If (1) no Community Builder offers to buy the Community Builder Lot during the Marketing Period for the Fair Market Value (but in no event less than the Minimum Purchase Price), (2) the Parties and the Community Builder cannot agree on the form of Community Builder Purchase and Sale Agreement or (3) any such Community Builder defaults under the Community Builder Purchase and Sale Agreement, then the Community Builder Lot in question will not be sold to the specified Community Builder and instead will be available for purchase by another Community Builder under this Section 15.4; provided, however, that, if either Party so elects within ten (10) days after notice of a default by the Community Builder to pursue specific performance against the Community Builder, then Developer will initiate and diligently prosecute an action for specific performance. The initiating Party will bear the reasonable cost of the specific performance action if it is unsuccessful, but if it is successful, then both Parties will bear the cost in equal shares. Notwithstanding the above, if any Community Builder Lot has been subject to the marketing procedures for Sales of

Community Builder Lots in Section 15.6 twice, and has still not been sold to a Community Builder, then the Agency may elect to purchase the Community Builder Lot by delivering written notice to Developer within one hundred eighty (180) days after the agreement with the second Community Builder has formally terminated (as evidenced by written notice from Developer to the Agency, which notice will include reasonable documentation supporting the termination date). If the Agency does so elect, then the Agency may purchase such Lot on substantially the same terms and conditions as in the agreement with the second Community Builder, with reasonable adjustments to reflect the Agency's status as buyer and the extended time frame. If the Lot has been offered to Community Builders under this Section 15.4 twice, and no agreement has been entered into with a Community Builder, then the one hundred eighty (180) day period for the Agency's option will be measured from the end of the Marketing Period for the second offer to Community Builders, and the terms of the option will be equivalent to the terms offered to Community Builders on the second round, with reasonable adjustments to reflect the Agency's status as buyer and the extended time frame, or on other terms mutually satisfactory to Developer and the Agency. If the Agency does not elect to purchase the Lot within the one hundred eighty (180) day period, then the Parties will initiate a Third-Party Sale under Section 15.3(c).

15.5 New DDA. At closing of the purchase and sale of a Lot, all Transferees shall execute, deliver and record a Vertical DDA for the Lot(s) conveyed incorporating the terms and conditions included in Attachment 27, which will be recorded immediately prior to the grant deed conveying the Lot in question. Except as expressly provided otherwise in this Agreement or in the Guaranty, no Transferee shall be liable for an Event of Default by Developer or another Transferee in the performance of its respective obligations under this Agreement, and Developer shall not be liable for the default by any Transferee in the performance of its respective obligations under such Vertical DDA.

15.6 Criteria for Developer/Community Builder Ventures and Marketing Procedures. The criteria for Developer/Community Builder Ventures, and marketing procedures for Community Builder Lots, are set forth in Section 3.2 of Exhibit B of Attachment 24.

SECTION 16. RELOCATION ASSISTANCE

In the event there are tenants or other lawful occupants on any portion of the Project Site who require relocation, Developer shall comply with the requirements of the California Relocation Act (California Government Code §§ 7260 *et seq.*) to the extent it is applicable to such tenant. Developer shall consult with the Agency regarding, and the Agency and Developer shall cooperate in effecting, such relocations in an efficient manner, and all reasonable out-of-pocket costs incurred in connection with the same shall be included as Approved Expenses to the extent included in the Approved Budget under the Financing and Revenue Sharing Plan; provided, however, that all relocation costs attributable to leases entered into by Developer shall be at Developer's sole cost.

SECTION 17. INDEMNITY

17.1 General Indemnity. Except as provided in Section 17.2, Developer shall defend, indemnify and hold harmless the Indemnified Parties and their successors and assigns from and against all Losses arising from or as a result of (a) the noncompliance of Developer with this Agreement, (b) the noncompliance of the Infrastructure with any federal, state or local laws or regulations, including those relating to access, or any patent or latent defects therein or (c) the death of any person or any accident, injury, loss or damage whatsoever caused to any person or to the property of any person which shall occur in the Redevelopment Area and which shall be directly or indirectly caused by the negligent or willful act or omission of Developer or its officers, employees, agents, contractors, subcontractors or others for whom it is responsible, except (as to any particular Indemnified Party) to the extent caused by the willful misconduct or the active negligence of that Indemnified Party.

In addition to the above, Developer shall defend, indemnify and hold harmless the Indemnified Parties and their successors and assigns from and against all Losses arising directly or indirectly out of or connected with contracts or agreements entered into by Developer in connection with its performance under this Agreement, except (as to any particular Indemnified Party), to the extent caused by the willful misconduct or the active negligence of that Indemnified Party.

17.2 Common Law Remedies. The agreement to indemnify, defend and hold harmless set forth in Section 17.1 is in addition to, and in no way shall be construed to limit or replace, any other obligations or liabilities which Developer may have to the Agency in this Agreement, at common law or otherwise except as same may be limited by the provisions of Section 13.

17.3 Defense of Claims. The Agency will give prompt notice to Developer with respect to any suit or claim initiated or threatened against the Agency which the Agency believes is likely to give rise to a claim for indemnity hereunder. In no event will such notice be given later than the earlier of (a) ten (10) days after valid service of process as to any filed suit or (b) fifteen (15) days after receiving written notification of the filing of such suit or the assertion of such claim. If notice is not given to Developer within the time periods specified above, then Developer's liability hereunder shall continue except to the extent Developer can show that it was prejudiced as a result of such delay. At its option, but subject to the reasonable consent and approval of the Agency, Developer shall be entitled to control the defense, compromise or settlement of any such matter through counsel of Developer's own choice; provided, however, that in all cases the Agency shall be entitled to participate in such defense, compromise or settlement at its own expense. If Developer shall fail, however, in the Agency's reasonable judgment, within a reasonable time following notice from the Agency alleging such failure (which in no event will exceed thirty (30) days after Developer's receipt of such notice), to take reasonable and appropriate action to defend, compromise or settle such suit or claim, then the Agency shall have the right promptly to hire counsel at Developer's sole expense to carry out such defense, compromise or settlement, which expense shall be immediately due and payable to the Agency upon the Agency's delivery to Developer of a properly detailed invoice therefor.

SECTION 18. MORTGAGEE PROVISIONS

The Parties anticipate that the Mello-Roos Bonds, together with the revenues from Lot sales and any other financing Developer may acquire that is not secured by the Project Site or this Agreement, will provide sufficient financing for construction of the Horizontal Improvements. Therefore, Developer shall not have the right to grant any Mortgages on the Project Site. Nothing in this Section shall prohibit a Transferee of a Lot from granting any Mortgage under the terms and conditions provided in the Vertical DDA.

SECTION 19. RESTRICTIONS ON THE SITE AND DEVELOPMENT

19.1 General Restrictions. The Project Site, the Horizontal Improvements and the Agency Housing Parcels and the improvements thereon shall be devoted only to the uses permitted by (a) the Redevelopment Plan, (b) the Declaration of Restrictions, (c) the Amended Design for Development for Vertical Improvements and (d) this Agreement. After the Effective Date, and except as may be required by a Conflicting Law, the Agency shall not amend the Redevelopment Plan, nor the Amended Design for Development for Vertical Improvements (in the form agreed upon and adopted in satisfaction of the closing condition specified in Section 6.6(c)(8)(h)), in a manner that materially and adversely affects Developer's rights and obligations under this Agreement in connection with Phase 1, without Developer's prior written consent. The Agency reserves the right in its sole discretion to amend the Redevelopment Plan and the Amended Design for Development for Vertical Improvements in connection with Phases of the Shipyard other than Phase 1. In addition, after the Effective Date, the Agency will not enact a new exaction applicable to the Vertical Improvements in addition to those in existence as of the Effective Date, excluding new exactions to operate and maintain the Open Space to the extent the Agency and Developer do not agree upon an alternative funding plan for such operation and maintenance that is satisfactory to the Agency. This restriction does not prevent the Agency from collecting the Agency Costs relating to Vertical Improvements, nor does it prevent the City from enacting new exactions applicable to the Vertical Improvements.

19.2 Restrictions Before Conveyance. Prior to conveyance of the Project Site to Developer, the Project Site shall be used only for the uses permitted under the Interim Lease.

19.3 Nondiscrimination.

(a) There shall be no discrimination against or segregation of any person or group of persons on account of age, race, color, creed, sex, sexual orientation, gender identity, marital or domestic partner status, disabilities (including AIDS or HIV status), religion, national origin or ancestry by Developer or any occupant or user of the Project Site in the sale, lease, rental, sublease, Transfer, use, occupancy, tenure or enjoyment of the Project Site, or any part thereof. Neither Developer itself (nor any person or entity claiming under or through it), nor any occupant or user of the Project Site or any Transferee, successor, assign or holder of any interest in the Project Site or any person or entity claiming under or through such Transferee, successor, assign or holder, shall establish or permit any such practice or practices of discrimination or segregation in connection with the Project Site, including without limitation, with reference to the selection, location, number, use or occupancy of buyers, tenants, vendees or others. However, Developer shall not be in default of its obligations under this Section where there is a

judicial action or arbitration involving a bona fide dispute over whether Developer is engaged in discriminatory practices and Developer promptly acts to satisfy any judgment or award against Developer.

(b) Any Transferee, successor, assign, or holder of any interest in the Project Site, or any occupant or user thereof, whether by contract, lease, rental, sublease, license, deed, deed of trust, Mortgage or otherwise, and whether or not any written instrument or oral agreement contains the above prohibitions against discrimination, shall be bound hereby and shall not violate in whole or in part, directly or indirectly, the nondiscrimination requirements set forth above.

19.4 Effect, Duration and Enforcement of Covenants.

(a) The covenants provided in this Section 19 shall be covenants running with the land and they shall be, in any event and without regard to technical classification or designation, legal or otherwise, and except only as otherwise specifically provided in this Agreement (i) binding for the benefit and in favor of the Agency, as beneficiary, as to all covenants set forth in this Section 19; and the City and the owner of any other land or of any interest in any land in the Redevelopment Area (as long as such land remains subject to the land use requirements and restrictions of the Redevelopment Plan and the Declaration of Restrictions), as beneficiary, as to the covenants provided in Sections 19.1 and 19.3, and their respective successors and assigns; and (ii) binding against Developer, its successors and assigns to or of the Project Site and any improvements thereon or any part thereof or any interest therein, and any party in possession or occupancy of the Project Site or the improvements thereon or any part thereof. The covenants provided in this Section 19 (except for the covenants provided in Section 19.1(a) through (d)) shall remain in effect without limitation as to time, and the covenants in Section 19.1(a) through (d) shall remain in effect for the duration of the periods provided for in such documents; provided, however, that such agreements and covenants shall be binding on Developer itself, each successor in interest or assign, and each party in possession or occupancy, respectively, only for such period as it shall have title to or an interest in or possession or occupancy of the Project Site or any part thereof. In addition, if the Agency becomes the fee owner of the Project Site or any portion thereof, whether voluntarily or involuntarily, then the covenants contained in this Section 19 (except those contained in Section 19.3, the Redevelopment Plan, the Declaration of Restrictions and the Amended Design for Development for Vertical Improvements, if still in effect) shall terminate and be of no further force or effect as to the Project Site or the portion thereof which the Agency owns.

(b) In amplification, and not in restriction, of the provisions of the preceding Sections, the Agency, the City and their respective successors and assigns, as to the covenants provided in this Section 19 of which they are stated to be beneficiaries, shall be beneficiaries both for and in their own right and also for the purposes of protecting the interest of the BVHP Area and other parties, public or private, and without regard to whether the Agency or the City has at any time been, remains, or is an owner of any land or interest therein to which, or in favor of which, such covenants relate. The Agency, the City and their respective successors and assigns shall have the right, as to any and all of such covenants of which they are stated to be beneficiaries, to exercise all the rights and remedies, and to maintain any actions at law or suits in equity or other proper proceedings, to enforce such covenants to which it or any other

beneficiaries of such covenants may be entitled including without limitation, restraining orders, injunctions and/or specific enforcement, judicial or administrative. Any owner of land or of any interest in land in the Redevelopment Area shall also have such rights as to the covenants contained in Sections 19.1(a) and (b) as shall be permitted by law.

(c) The conveyance of the Project Site by the Agency to Developer shall be made and accepted upon and subject to the express covenants contained in this Section 19 which, except for those contained in Section 19.3, also shall be conditions subsequent in the Quitclaim Deed. In addition to any other remedies that the Agency may have and at the Agency's option, the violation of such conditions subsequent shall cause title to the Project Site (or title to Parcel A-1, if the violation occurs after the Close of Escrow on Parcel A-1 and before the Close of Escrow on Parcel B-1) and any improvements thereon to be conveyed to the Agency, which shall have the right of immediate re-entry onto the Project Site (or Parcel A-1, as the case may be), in the event of any such breach; provided, however, that any such re-entry shall be subject to the provisions of the Quitclaim Deed and of Section 13.

(d) Developer shall be entitled to notice and shall have the right to cure any breach or violation of all or any of the above in accordance with Section 13.

(e) The provisions of this Section 19 shall not be affected by Agency's issuance of a Certificate of Completion.

19.5 Lead-Based Paint Prohibition. Developer shall comply with the regulations issued by the Secretary of Housing and Urban Development set forth in 37 F.R. 22732-3 and all applicable rules and orders issued thereunder which prohibit the use of lead-based paint in residential structures undergoing federally-assisted construction or rehabilitation and requiring the elimination of lead-based paint hazards.

SECTION 20. MITIGATION MEASURES

In order to mitigate the significant environmental impacts of the development contemplated by this Agreement, construction and subsequent operation of all or any part of the Infrastructure shall be in accordance with (a) the EIR Mitigation Measures (Attachment 11), including the commitments for implementing the Mitigation Measures as specified in this Section 20 and in the Environmental Impact Report and (b) the Plan for Environmental Investigation and Remediation During Development at Hunters Point Shipyard, together with implementing ordinances and a soil and groundwater management plan, if and when enacted by the City's Board of Supervisors. In addition to the EIR Mitigation Measures, Developer shall comply with all applicable environmental laws. As appropriate, mitigation measures and applicable provisions of environmental laws shall be incorporated by Developer into any contract or subcontract for the construction or operation of the Horizontal Improvements.

Since certification of the EIR and with development of the Phase 1 program, additional information has become available about the specific implementation of the EIR Mitigation Measures. As set forth in this Section 20 and the Environmental Impact Report, the EIR Mitigation Measures will be implemented in accordance with the following (unless otherwise indicated, Section references are to Attachment 11):

(a) **Section 2.B.** This measure shall be implemented for each construction site and its immediate surroundings during site clearing, grading, excavation and trucking of soil and demolition debris and for all unpaved and inactive areas at each construction site. In addition to the BAAQMD guidelines specified in Section 2.B, contractors shall water or treat with dust suppression solutions construction and vehicular dust including all unpaved, active portions of the construction site on an as-needed basis, but no less frequently than twice daily. Contractors' trucks shall be covered before leaving the area of the construction site or when storing loose soil or sand in a parked position;

(b) **Section 2.C.** The standards imposed are in addition to BAAQMD standards, and, therefore, permits and variances obtained from BAAQMD will not satisfy these standards;

(c) **Section 3.A.** Contractors shall comply with the City's applicable ordinances on noise control, which limit the hours during which heavy demolition, certain construction activities and truck traffic may occur in order to prevent unreasonable noise and/or vibration from impacting nearby residents (see also Closing condition Section 6.6(c)(14), requiring Agency and Developer to have incorporated into the Demolition and Deconstruction Plan noise and time restrictions for work undertaken by Developer);

(d) **Section 7.A.** (1) Developer will prepare and distribute to applicable lessees an "environmental safety manual" describing restricted or prohibited activities, including the rationale therefor, and with particular notice about any hazards posed as a result of digging by such lessees' pets, (2) Developer will give notifications, including Proposition 65 warnings, as required by applicable law, (3) signs will be well-placed and easily seen throughout areas in use prior to complete remediation and (4) areas in reuse prior to complete remediation will be surrounded by buffer zones separating them from adjoining areas of incomplete remediation in accordance with the requirements of applicable regulatory agencies;

(e) **Section 7.B.** Contractors shall store hazardous substances, construction materials and waste resulting from demolition in compliance with applicable law, including without limitation the Resource Conservation and Recovery Act and the Clean Water Act. Compliance procedures shall be set forth in the Environmental Safety Manual;

(f) **Section 7.D.** Contractors shall perform lead and asbestos abatement, storage and transportation off-site in compliance with applicable law, including without limitation the Resource Conservation and Recovery Act. Compliance procedures shall be set forth in the Environmental Safety Manual;

(g) **Section 7.E.** Developer shall prepare a construction contingency plan for unanticipated hazardous materials that includes the elements set forth in the Environmental Impact Report;

(h) **Section 7.F.** Developer will implement best management practices ("BMPs") to prevent discharges to wetland areas including measures to trap or filter sediments in runoff such as silt fences, straw bale barriers or sand bag barriers; measures to divert runoff such as temporary drains or swales; physical stabilization of construction areas by means such as

spraying with water; and preventing release of construction pollutants like concrete, fuel and lubricating oils;

(i) **Section 8.B.** (1) The environmental safety manual referenced in clause (d) will include recommendations on earthquake preparedness, including a section identifying particular liquefaction sensitivity and dangers resulting from liquefaction and (2) a prohibition on constructing improvements on areas deemed liquefaction sensitive until such activity is determined to meet appropriate seismic standards under the City's building code and other applicable laws (any fill activities will also be subject to all applicable laws, but use of fill will not be limited solely to enhancing seismic stability, since fill may be desirable and necessary for the redevelopment effort);

(j) **Section 9.A.** Developer shall study the potential for separating the storm and sanitary water transport systems within the southern hillside portion of Parcel A-1 known as Lot 48;

(k) **Section 9.B.** Developer working with the San Francisco Public Utilities Commission shall develop a storm water management plan that contains the measures set forth in the Environmental Impact Report, including soil runoff controls, educational components to control waste discharges to storm sewers, instructional materials to lessees recommending means of proper disposal of waste and housekeeping elements such as street sweeping to keep silt and trash on streets from entering storm sewers;

(l) **Section 10.** In addition to the requirements of Section 3 of this Agreement, and pursuant to Section 6.6(c)(15), Developer shall study the feasibility of (1) using sustainable and other environmentally sound construction materials, (2) using LED emitters and other alternative technologies, (3) using solar collection panels, wind turbines, tidal power (from off pier stations), and other potential alternative energy generation sources, to satisfy the energy needs of the Shipyard and (4) in conjunction with City agencies studying this issue, locating a small package plant on site to handle the sanitary waste collection and treatment needs generated by reuse of the Shipyard, as opposed to shunting that material back into the Bayview Water Treatment Plant system;

(m) **Section 12.D.** Contractors shall comply with the Native American Graves, Patrimony and Repatriation Act, including consulting with a Native American consultant to the extent required by such Act. Developer will include the Planning Department's Alert Sheet in each set of construction specifications and require contractors and subcontractors to return the Alert Sheet to Planning with an indication that it has been read and understood; and

(n) **Section 12.D.** Contractors shall comply with all applicable laws governing Shipyard historic resources, including without limitation the Memorandum of Agreement with the State Historic Preservation Office.

SECTION 21. EQUAL OPPORTUNITY AND OTHER PROGRAMS

Developer shall comply with the requirements of the Prevailing Wage Requirements, the Card Check Agreement, the Minimum Compensation Policy, the Health Care Accountability Policy, the Equal Benefits Policy, the Community Ownership, Financing and

Benefits, the "Equal Opportunity Program and Additional Business, Employment, Construction Assistance/Opportunities and Community Benefits Program" provided by Developer and related requirements contained in Attachments 13, 14, 15, 16, 17, 23 and 24 respectively.

SECTION 22. MISCELLANEOUS

22.1 Incorporation of Attachments and Recitals. Each Attachment attached to this Agreement is incorporated herein and made a part hereof as if set forth in full.

22.2 Notices. A notice or communication under this Agreement by either Party to the other shall be sufficiently given or delivered if dispatched by hand, a nationally recognized courier, or by registered or certified mail, postage prepaid, addressed as follows:

In the case of a notice of communication to the Agency:

San Francisco Redevelopment Agency
770 Golden Gate Avenue
San Francisco, California 94102-3102
Attn: Executive Director
Facsimile: (415) 749-2525

with a copy to:

San Francisco Redevelopment Agency
770 Golden Gate Avenue
San Francisco, California 94102-3102
Attn: Legal Division
Facsimile: (415) 749-2575

In the case of a notice or communication to Developer:

Lennar/BVHP Partners
c/o Lennar Partners
18401 Von Karman, Suite 540
Irvine, California 92612
Attn: Hunters Point Asset Manager
Facsimile: (949) 442-6175

with copies to:

Lennar Partners
18401 Von Karman, Suite 540
Irvine, California 92612
Attn: General Counsel
Facsimile: (949) 442-6175

and

Sheppard, Mullin, Richter & Hampton, LLP
Four Embarcadero Center, 17th Floor
San Francisco, California 94111-4106
Attn: Robert A. Thompson, Esq.
Facsimile: (415) 434-3947

For the convenience of the Parties, copies of notices may also be given by facsimile, but such copies do not constitute official notice.

Every notice given to a Party hereto, pursuant to the terms of this Agreement, must state (or must be accompanied by a cover letter that states) substantially the following:

(a) the Section of this Agreement pursuant to which the notice is given and the action or response required, if any;

(b) if applicable, the period of time within which the recipient of the notice must respond thereto;

(c) if applicable, that the failure to object to the notice within a stated time period will be deemed to be the equivalent of the recipient's approval or disapproval of or consent to the subject matter of the notice;

(d) if approval is being requested, shall be clearly marked "Request for Approval"; and

(e) if a notice of a disapproval or an objection which requires reasonableness, shall specify with particularity the reasons therefor.

Any mailing address or facsimile number may be changed at any time by giving written notice of such change in the manner provided above at least ten (10) days prior to the effective date of the change. All notices under this Agreement shall be deemed given, received, made or communicated on the date personal receipt actually occurs or, if mailed, on the delivery date or attempted delivery date shown on the return receipt. No Party may give official or binding notice by facsimile. The effective time of a notice shall not be affected by the receipt, prior to receipt of the original, of a facsimile copy of the notice.

22.3 Time for Performance.

(a) Except as provided herein, all performance (including cure) dates expire at 5:00 p.m. California time on the performance or cure date. Provisions in this Agreement relating to number of days shall be calendar days, unless otherwise specified, provided that if the last day of any period to give notice, reply to a notice or to undertake any other action is not a Business Day, then the last day for undertaking the action or giving or replying to the notice shall be the next succeeding Business Day.

(b) Time is of the essence in the performance of all the terms and conditions of this Agreement.

22.4 Non-Merger in Deed. None of the provisions of this Agreement are intended to, or shall be, merged by reason of the Quitclaim Deed transferring title to all or any portion of the Project Site from the Agency to Developer or any successor in interest, and any such Quitclaim Deed shall not be deemed to affect or impair the provisions and covenants of this Agreement.

22.5 Unavoidable Delays.

(a) **Postponement.** A Party who is subject to Unavoidable Delay in the performance of an obligation hereunder, or in the satisfaction of a condition to the other Party's performance hereunder, shall be entitled to a postponement of the time for performance of such obligation or satisfaction of such condition during the period of enforced delay attributable to an event of Unavoidable Delay, subject to the provisions of this Section 22.5.

(b) **Notice of Enforced Unavoidable Delay.** The Unavoidable Delay provisions of this Section shall not apply unless (i) the Party seeking to rely upon such provisions shall have given notice to the other Party, within thirty (30) days after obtaining knowledge of the beginning of an Unavoidable Delay, of such delay and the cause or causes thereof, to the extent known and (ii) the Party claiming the Unavoidable Delay must at all times be acting diligently and in good faith to avoid foreseeable delays in performance, and to remove the cause of the delay or to develop a reasonable alternative means of performance.

(c) **Extensions.** The Agency or Developer may extend time for the other Party's performance of any term, covenant or condition of this Agreement or permit the curing of any default upon such terms and conditions as it determines appropriate; provided, however, that any such extension or permissive curing of any particular default shall not operate to release any of the other Party's obligations, nor constitute a waiver of the extending Party's rights with respect to any other term, covenant or condition of this Agreement or any other Event of Default under this Agreement. Developer acknowledges that changes in the Schedule of Performance and any other amendments to this Agreement will require Agency Commission approval.

In addition to matters set forth in the immediately preceding paragraph, the Parties may extend the time for performance by either or both Parties of any term, covenant or condition of this Agreement by a written instrument signed by authorized representatives of both Parties without the execution of a recorded amendment to this Agreement, and any such written instrument shall have the same force and effect and impart the same notice to third parties as a recorded amendment to this Agreement.

22.6 Attorneys' Fees.

(a) Should either Party institute any action or proceeding in court to enforce any provision hereof, or should the Agency institute any action or proceeding in court for damages by reason of an alleged breach of any provision of this Agreement, the prevailing Party shall be entitled to receive from the losing Party court costs or expenses incurred by the prevailing Party, including without limitation expert witness fees, document copying expenses, exhibit preparation costs, carrier expenses and postage and communication expenses, and such amount as the court may adjudge to be reasonable attorneys' fees for the services rendered the prevailing Party in such action or proceeding. Attorneys' fees under this Section 22.6 include attorneys' fees on any

appeal, and, in addition, a Party entitled to attorneys' fees shall be entitled to all other reasonable costs and expenses incurred in connection with such action.

(b) For purposes of this Agreement, reasonable fees of attorneys and any in-house counsel for the Agency or Developer shall be based on the fees regularly charged by private attorneys with an equivalent number of years of professional experience in the subject matter area of the law for which the Agency's or Developer's in-house counsel's services were rendered who practice in the City in law firms.

22.7 Successors and Assigns/No Third-Party Beneficiary. Subject to the provisions of Sections 14 and 15, this Agreement shall be binding upon and inure to the benefit of the successors and assigns of the Agency and the Developer, and where the term "Agency" or "Developer" is used in this Agreement, it shall mean and include their respective successors and assigns. This Agreement is made and entered into only for the protection and benefit of the Parties and their successors and assigns. Except as expressly provided otherwise in this Agreement, as for instance in regard to the City, no other Person shall have or acquire any right or action of any kind based upon the provisions of this Agreement.

22.8 Estoppel Certificates. The Agency or Developer, within fifteen (15) days after receipt of written notice from the other, shall execute and deliver to the requesting Party an estoppel certificate certified by Developer or the Agency, as applicable, and containing the following information:

(a) Whether or not this Agreement is unmodified and in full force and effect. If there has been a modification of this Agreement, the certificate shall state that this Agreement is in full force and effect as modified, and shall set forth the modification, and if this Agreement is not in full force and effect, the certificate shall so state;

(b) Whether or not the Agency or Developer contends that the other Party has committed an Event of Default under this Agreement, or whether any event, act or omission has occurred that, with notice and the expiration of any cure period without cure, would become an Event of Default by the other Party; and

(c) Whether or not there are then existing set-offs or defenses against the enforcement of any right, remedy, duty or obligation of the other Party.

22.9 Brokers. Developer and the Agency each represents and warrants to the other that it has not employed a broker or a finder in connection with the transactions contemplated by this Agreement, and agrees to defend, indemnify and hold the other harmless from any Losses arising from or in connection with the claims of any broker or finder asserted through the indemnifying Party.

22.10 Governing Law. This Agreement shall be governed by and construed in accordance with the internal laws of the State of California.

22.11 Authority and Enforceability. Developer and the Agency each represents and warrants to the other that the execution and delivery of this Agreement, and the performance of its respective obligations hereunder, have been duly authorized by all necessary action on its

part, will not conflict with, result in any violation of, or constitute a default under, any provision of any agreement or other instrument binding upon or applicable to it, nor of any present law or governmental regulation or court decree binding upon or applicable to it.

22.12 Further Assurances. Developer and the Agency each covenant, on behalf of itself and its successors and assigns, to take all actions and to do all things, and to execute, with acknowledgment or affidavit if required, any and all documents and writings that may be reasonably necessary or proper to achieve the purposes and objectives, or to correct inadvertent errors, in the drafting of this Agreement. The Agency's Executive Director is authorized to execute on behalf of the Agency any closing or similar documents and any contracts, agreements, memoranda or similar documents with state, regional and local entities or enter into any tolling agreement with any Person that are necessary or proper to achieve the purposes and objectives of this Agreement, if the Executive Director determines that the document or Agreement is necessary or proper and is in the Agency's best interests.

22.13 Eminent Domain. The exercise by the Agency of its eminent domain power with regard to any portion of the Redevelopment Area owned by Developer in a manner which precludes performance by Developer of any of its material obligations (or would otherwise give rise to an Event of Default by Developer) hereunder shall constitute a breach by the Agency of its obligations under this Agreement.

22.14 Severability. Invalidation of any provision of this Agreement, or of its application to any Person, by judgment or court order shall not affect any other provision of this Agreement or its application to any other Person or circumstance, and the remaining portions of this Agreement shall continue in full force and effect, unless enforcement of this Agreement as invalidated would be unreasonable or grossly inequitable under all relevant circumstances or would frustrate the fundamental purposes of this Agreement.

22.15 Entire Agreement; Supersedure. This Agreement (including all Attachments), the Redevelopment Plan and the Interagency Cooperation Agreement contain all the representations and the entire agreement between Developer and the Agency with respect to the subject matter of this Agreement. Any prior correspondence, memoranda, agreements, warranties or representations relating to such subject matter are superseded in total by this Agreement. No prior drafts of this Agreement or changes from those drafts to the executed version of this Agreement shall be introduced as evidence in any litigation or other dispute resolution proceeding by either Developer or the Agency or other Person and no court or other body shall consider those drafts in interpreting this Agreement.

22.16 No Party Drafter. Although certain provisions of this Agreement were drafted by the Agency and certain provisions were drafted by Developer, the provisions of this Agreement shall be construed as a whole according to their common meaning and not strictly for or against either Party in order to achieve the objectives and purposes of the parties.

22.17 Approvals and Consents. Unless otherwise expressly provided in this Agreement, whenever approval, consent or satisfaction is required of either Developer or the Agency pursuant to this Agreement, it shall not be unreasonably withheld or delayed. The reasons for disapproval of consent shall be stated in reasonable detail in writing. Approval by

Developer or the Agency of any act or request by the other shall not be deemed to waive or render unnecessary approval to or of any similar or subsequent acts or requests. Unless otherwise expressly provided in writing, approvals or consents of the Agency will be given by the Agency's Executive Director; provided that, only the Agency Commission has authority to amend this Agreement. The requirements for approvals under this Agreement shall extend to and bind the partners, officers, directors, shareholders, trustees, beneficiaries, agents, elective or appointive boards, commissions, employees and other authorized representatives of Developer and the Agency, and each such Person shall make or enter into, or take any action in connection with, any approval in accordance with these requirements.

22.18 Represented By Counsel. Developer and the Agency each acknowledges, warrants and represents that it has been fully informed with respect to, and represented by counsel of its choice in connection with the rights and remedies of and waivers by it contained in this Agreement and after such advice and consultation has presently and actually intended, with full knowledge of its rights and remedies otherwise available at law or in equity, to waive and relinquish those rights and remedies to the extent specified in this Agreement, and to rely solely on the remedies provided for in this Agreement with respect to any Event of Default by the other Party, or any other right that either Developer or the Agency seeks to exercise. The language of this Agreement must be construed as a whole according to its fair meaning.

22.19 Recordation. After complete execution, the Agency may record this Agreement in the City's official records. If this Agreement is terminated pursuant to its terms, either Party may record a notice of termination as provided in Section 6.9.

22.20 Counterparts. This Agreement may be executed in counterparts, each of which shall be deemed to be an original, and such counterparts may be assembled to form a single document.

22.21 Modification. Any modification or waiver of any provision of this Agreement or any amendment to it must be in writing and signed by a Person having authority to do so, on behalf of both the Agency and Developer.

IN WITNESS WHEREOF, the parties have executed this Agreement as of the date first set forth above.

Authorized by Agency Resolution
No. 179, adopted December 2, 2003

APPROVED AS TO FORM:

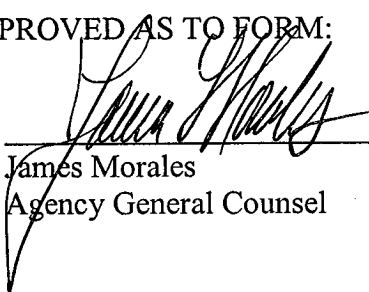
By: 
James Morales
Agency General Counsel

AGENCY:
Redevelopment Agency of the City and
County of San Francisco

By: 
[Executive Director]

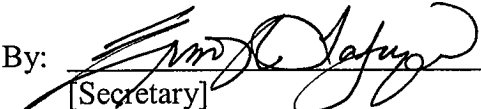
By: 
[Secretary]

DEVELOPER:
LENNAR/BVHP, LLC, a California limited
liability company

By: Lennar Southland I, Inc., a California
limited liability company, its managing
member.

By: 

Its: VICE PRESIDENT

CALIFORNIA ALL-PURPOSE ACKNOWLEDGMENT

State of California

County of SAN FRANCISCO

} ss.

On December 18, 2003, before me, Jennie Chin - Notary,
Date Name and Title of Officer (e.g., "Jane Doe, Notary Public")

personally appeared Gregory HAROLD McWilliam,
Name(s) of Signer(s)

- personally known to me
- proved to me on the basis of satisfactory evidence

to be the person(s) whose name(s) is/are subscribed to the within instrument and acknowledged to me that he/~~she~~/they executed the same in his/~~her~~/their authorized capacity(ies), and that by his/~~her~~/their signature(s) on the instrument the person(~~s~~), or the entity upon behalf of which the person(~~s~~) acted, executed the instrument.



WITNESS my hand and official seal.

Jennie Chin
Signature of Notary Public

Place Notary Seal Above

OPTIONAL

Though the information below is not required by law, it may prove valuable to persons relying on the document and could prevent fraudulent removal and reattachment of this form to another document.

Description of Attached Document

Title or Type of Document: Disposition & Development Agreement

Document Date: December 18, 2003 Number of Pages: _____

Signer(s) Other Than Named Above: _____

Capacity(ies) Claimed by Signer

Signer's Name: _____

- Individual
- Corporate Officer — Title(s): _____
- Partner — Limited General
- Attorney in Fact
- Trustee
- Guardian or Conservator
- Other: _____

Signer Is Representing: _____

RIGHT THUMBPRINT OF SIGNER

Top of thumb here

CALIFORNIA ALL-PURPOSE ACKNOWLEDGMENT

State of California }
County of SAN FRANCISCO } ss.

On December 18, 2003, before me, Jennie Chin - Notary,
Date Name and Title of Officer (e.g., "Jane Doe, Notary Public")
personally appeared Marcia Aita Rosen,
Name(s) of Signer(s)

- personally known to me
- proved to me on the basis of satisfactory evidence

to be the person(s) whose name(s) is/are subscribed to the within instrument and acknowledged to me that ~~he/she/they~~ executed the same in ~~his/her/their~~ authorized capacity(ies), and that by ~~his/her/their~~ signature ~~(s)~~ on the instrument the person ~~(s)~~, or the entity upon behalf of which the person ~~(s)~~ acted, executed the instrument.

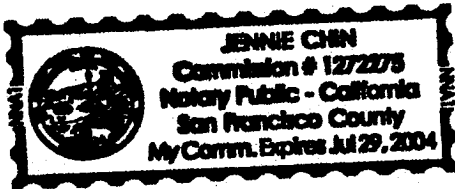

WITNESS my hand and official seal.

Jennie Chin
Signature of Notary Public

Place Notary Seal Above

OPTIONAL

Though the information below is not required by law, it may prove valuable to persons relying on the document and could prevent fraudulent removal and reattachment of this form to another document.

Description of Attached Document

Title or Type of Document: Disposition + Development Agreement

Document Date: December 18, 2003 Number of Pages: _____

Signer(s) Other Than Named Above: _____

Capacity(ies) Claimed by Signer

Signer's Name: _____

- Individual
- Corporate Officer — Title(s): _____
- Partner — Limited General
- Attorney in Fact
- Trustee
- Guardian or Conservator
- Other: _____

Signer Is Representing: _____

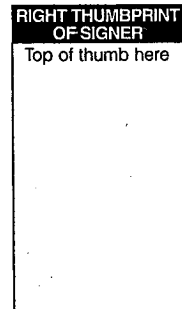

DUPLICATE

**RECORDING REQUESTED BY AND
WHEN RECORDED RETURN TO:**

**San Francisco Redevelopment Agency
770 Golden Gate Avenue
San Francisco, CA 94102
Attention: Development Services**

This document is exempt from payment of a recording fee pursuant to Government Code Section 2738.

Recorder's Stamp

DISPOSITION AND DEVELOPMENT AGREEMENT

**HUNTERS POINT SHIPYARD
PHASE 1**

by and between

**THE REDEVELOPMENT AGENCY
OF THE CITY AND COUNTY OF SAN FRANCISCO**

and

LENNAR/BVHP, LLC

Dated: December 2 , 2003

ATTACHMENTS

ATTACHMENTS

1. Legal Description of Phase 1 and of the Project Site (which excludes the Agency Parcels)
2. Map of Project Site and of Agency Parcels, showing Agency Housing Parcels and Community Facilities Parcels

Schedule A - Map showing SLC Land, including Pre-Exchange SLC Land and Post-Exchange SLC Land

Schedule B - Land Use Plan
3. Quitclaim Deed from Agency to Developer
4. Short Term License Agreement (Agency Parcels)
5. Redevelopment Area Declaration of Restrictions
6. Reversionary Grant Deed
7. Insurance (includes environmental insurance)
8. Guaranty
9. Infrastructure Plan

Exhibit A Demolition and Deconstruction

Exhibit B Grading and Landslide Repair

Exhibit C Infrastructure Within the Rights of Way (including streets and utilities)

Exhibit D Public Open Space
10. Schedule of Performance for Infrastructure Development
11. EIR Mitigation Measures
12. Plan for Environmental Investigation and Remediation During Development at Hunters Point Shipyard
13. Prevailing Wage Requirements
14. Form of Card Check Agreement
15. Minimum Compensation Policy

16. Health Care Accountability Policy
17. Equal Benefits Policy
18. Form of Engineer's/Architect's Certificate Re Compliance of Design with Laws re Access
19. Form of Engineer's/Architect's Inspection Certificate
20. Form of Engineer's/Architect's Certificate Re Compliance of Construction with Laws re Access
21. Form of Certificate of Completion
22. Affordable Housing Program
 - Exhibit A Distribution of Affordable Housing Units
 - Exhibit B Declaration of Rental Use Restriction
 - Exhibit C Declaration of Restrictions for For-Rent Affordable Housing Units
 - Exhibit D Declaration of Restrictions for For-Sale Affordable Housing Units
 - Exhibit E Memorandum of Option
 - Exhibit F Release of Option Rights
 - Exhibit G Major Phase Housing Data Table
 - Exhibit H Project Housing Data Table
 - Exhibit I Marketing and Operating Obligations
23. Community Ownership, Financing and Benefits Policies and Procedures
24. Equal Opportunity Program and Additional Business, Employment, Construction Assistance/Opportunities and Community Benefits Program (including African Marketplace)
 - Exhibit A Equal Opportunity Program
 - Rider 1 Construction Work Force
 - Rider 2 Equal Opportunity for Women and Minority Owned Business Enterprises
 - Rider 3 Permanent Work Force of Developer and Retail Tenants

Rider 4 First Source Referral Hiring and Job Training

Exhibit B Additional Business, Employment, Construction Assistance/Opportunities
and Community Benefits Program (including African Marketplace)

25. Financing and Revenue Sharing Plan

Exhibit A Preliminary Budget and Project Pro Forma

Exhibit B Description of Qualified Predevelopment Costs

Exhibit C Description of Qualified Pre-Agreement Costs

Exhibit D Tables: Agency Land Return/Developer Equity Return Formulas and
Examples

26. Option: Alternative Financing and Revenue Sharing Plan with Accelerated
Compensation for Land Value

27. Outline of Provisions of Vertical Disposition and Development Agreement

28. Transportation Management Plan

29. Interim Lease

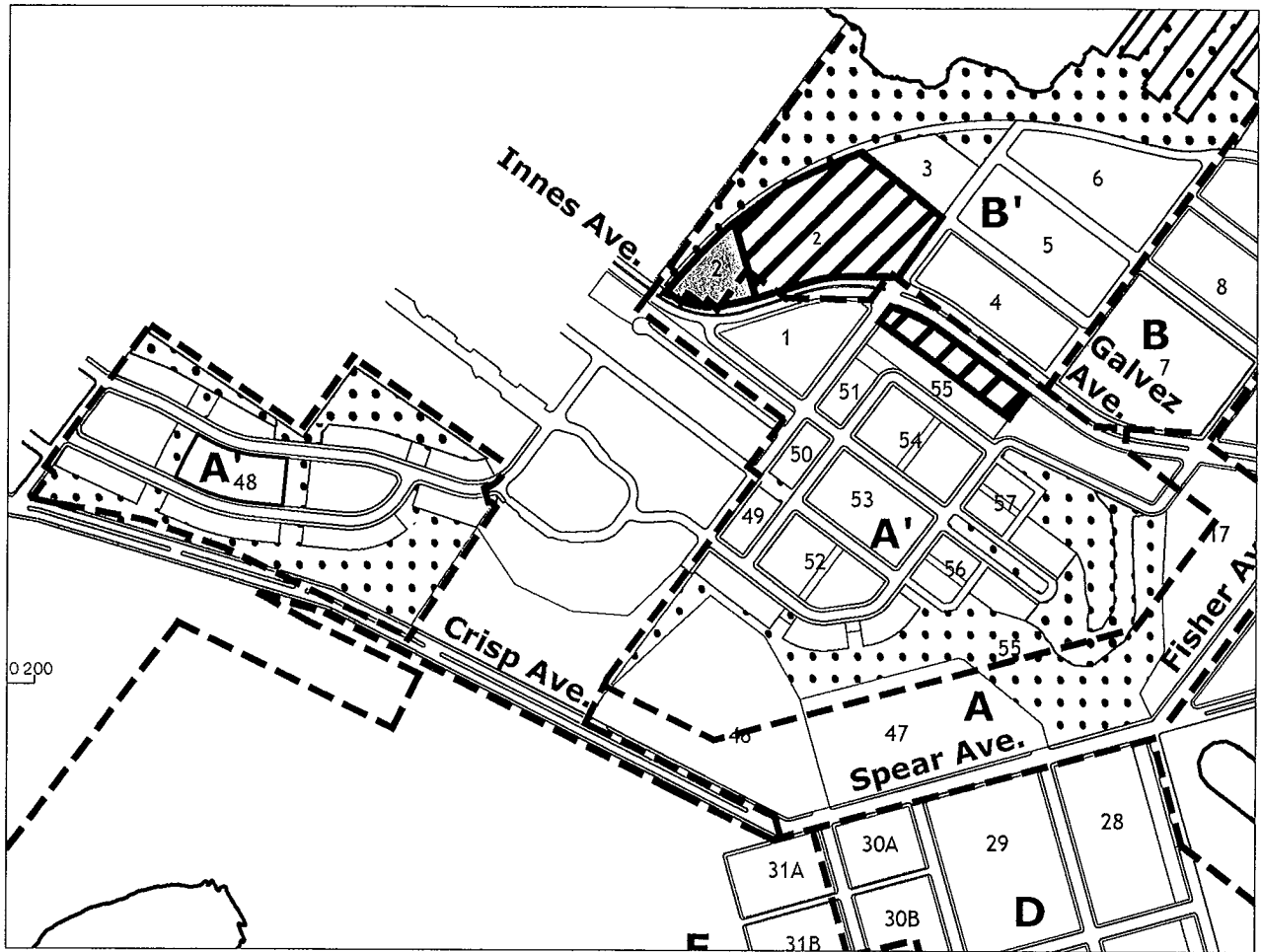



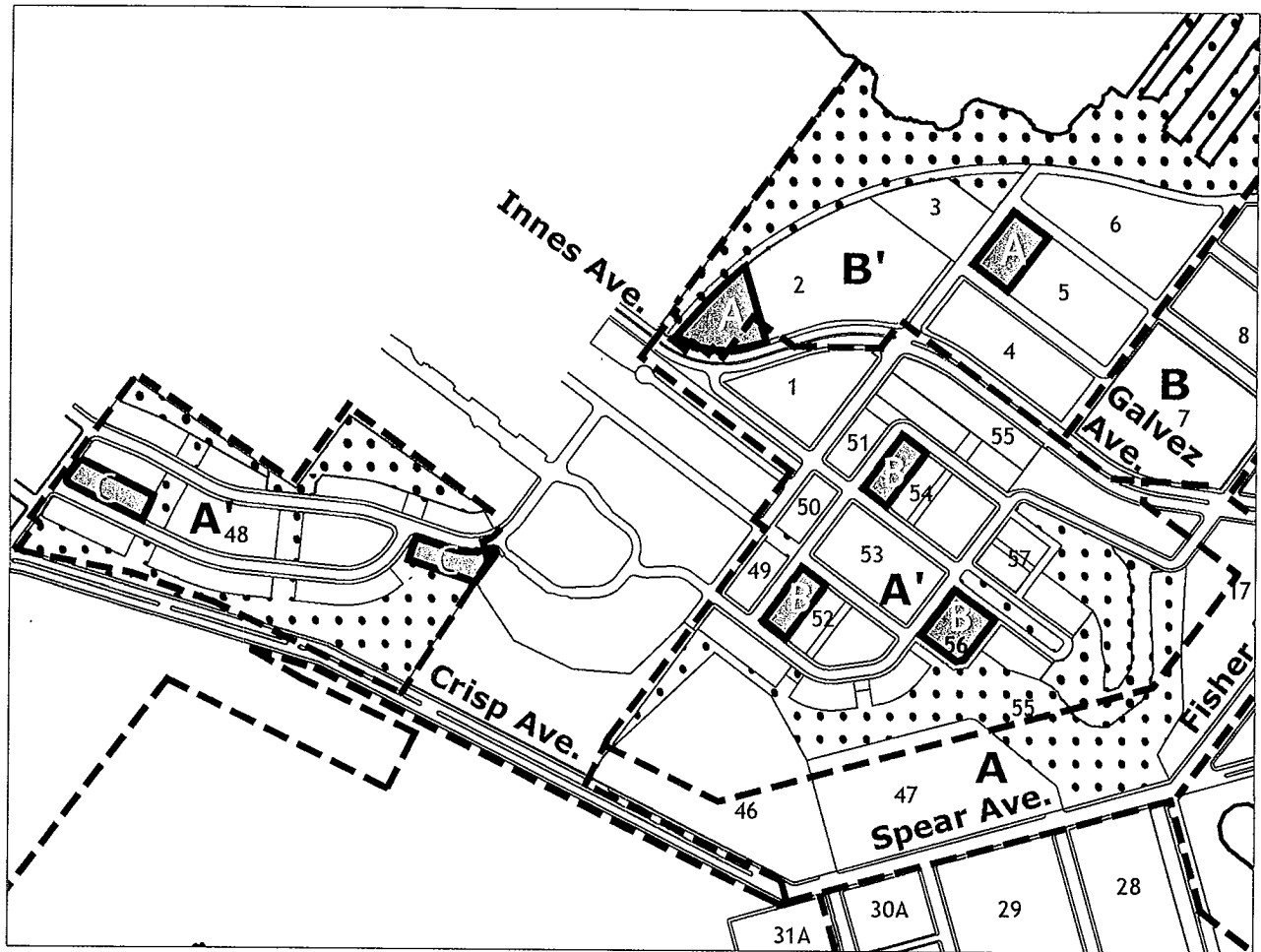

 Community Parcels

 Open Space

**Attachment 2 - "Map of Project Site and Community Parcels"
(Community Facilities Parcels)**



-  Affordable Housing Parcels
-  Lockwood Landing: 102 Units
-  Hilltop Parcels : 143 Units
-  Hillside Parcels: 75 Units

Total : 320 Units

-  Open Space

**Attachment 2 - "Map of Project Site and Agency Parcels"
(Agency Housing Parcels)**

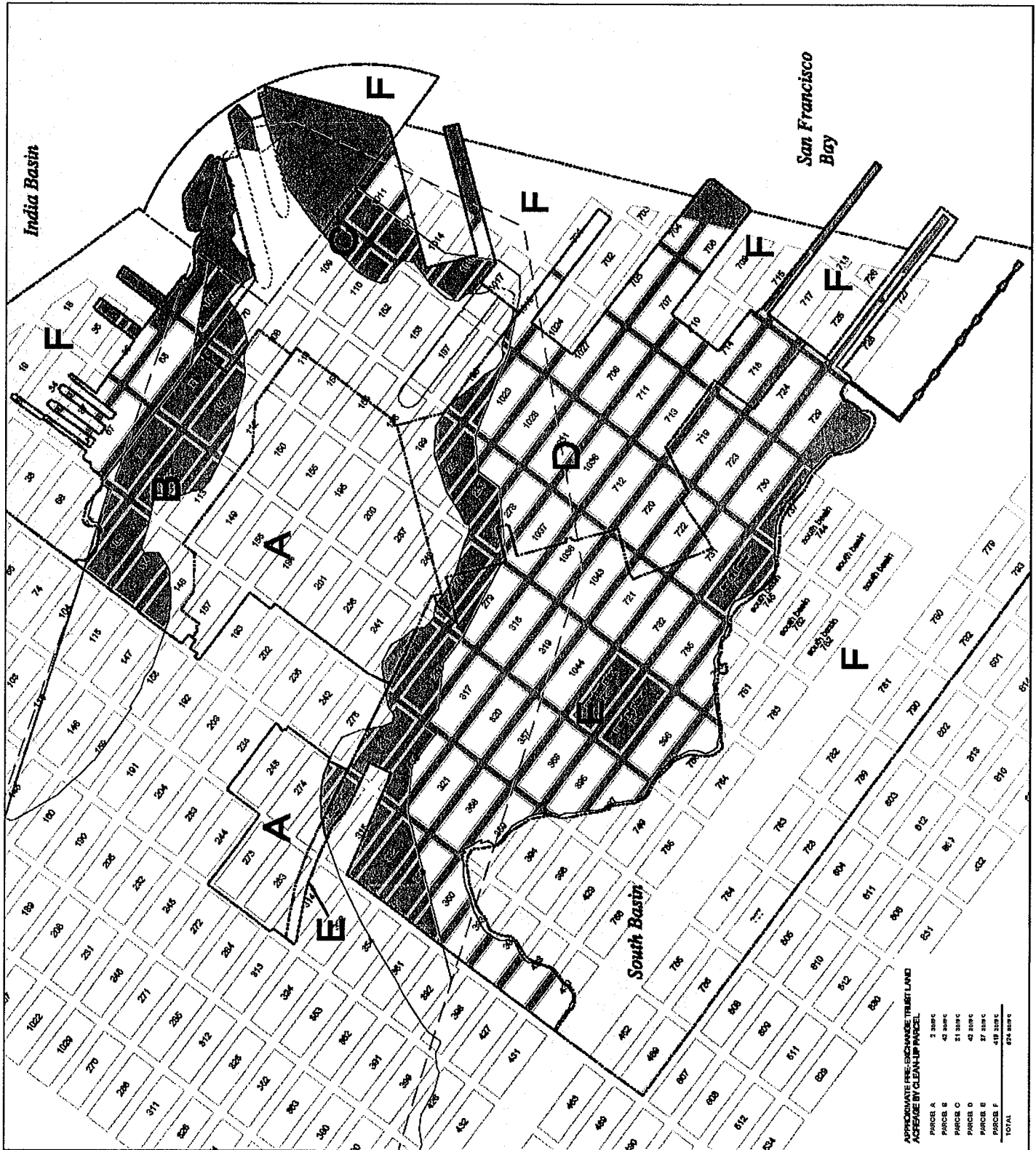

APPROXIMATE PRE-EXCHANGE TRUST LAND ACRES BY CLEAN-UP PARCEL

PARCEL A	3.00 AC
PARCEL B	42.00 AC
PARCEL C	21.00 AC
PARCEL D	42.00 AC
PARCEL E	27.00 AC
PARCEL F	418.00 AC
TOTAL	624.00 AC

**HUNTERS POINT SHIPYARD
EXISTING TRUST LAND**

- UPLANDS PRESENTLY SUBJECT TO TRUST
- HISTORIC SHORELINE (1869)
- STATUTORY HOMESTEAD ASSIGNMENT BOUNDARY
- DISBURSED HOMESTEAD ASSIGNMENT BOUNDARY
- STATUTORY DRY DOCK CO. BOUNDARY
- CLEAN-UP PARCEL BOUNDARY
- HISTORIC BLOCKS
- EXISTING SUBMERGED LANDS
- FORMER UPLANDS CURRENTLY SUBMERGED

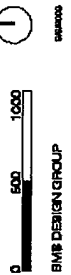

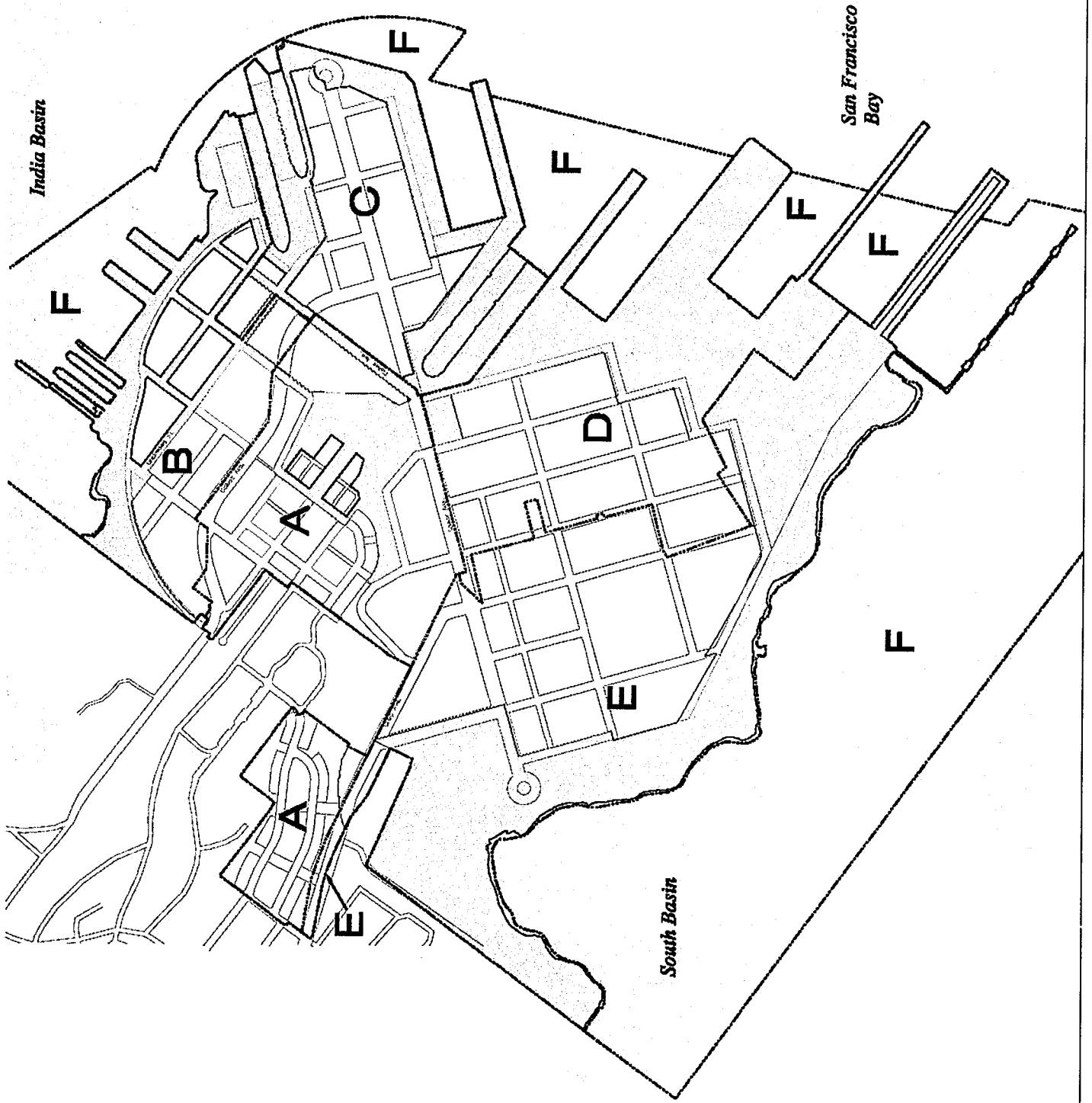





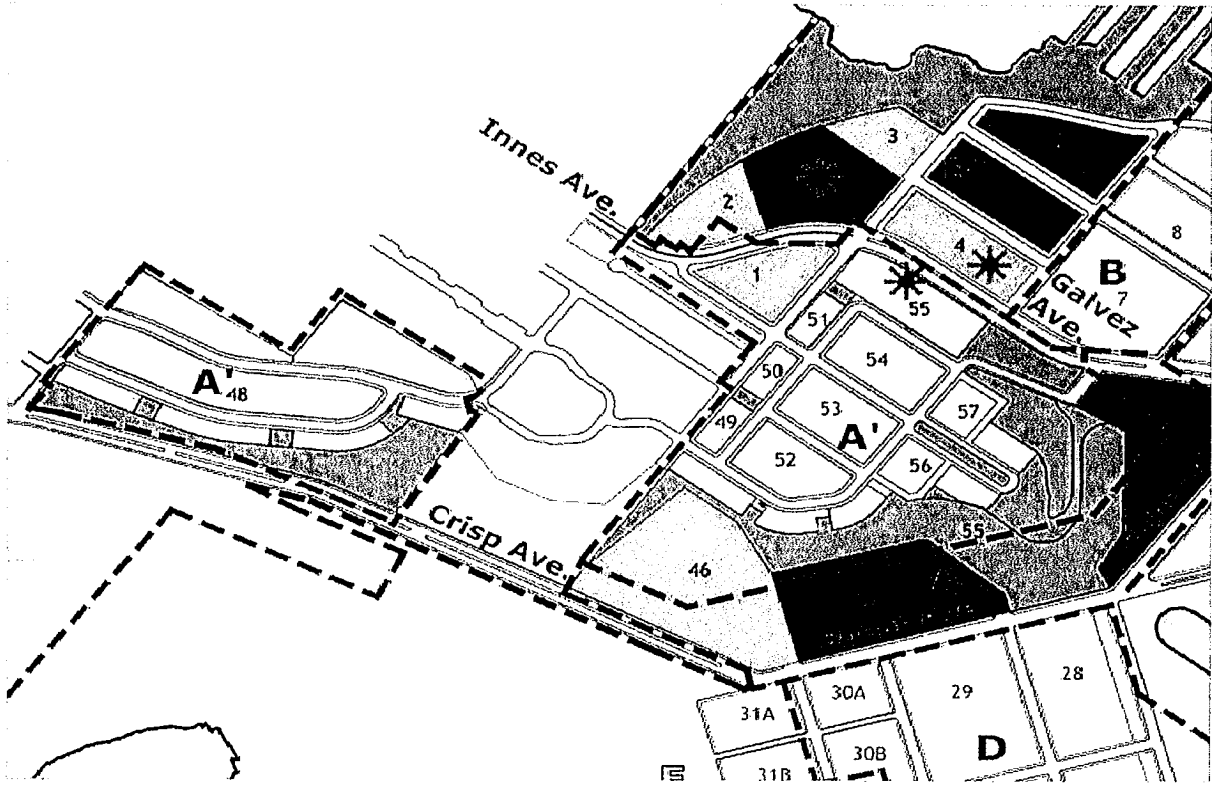

**HUNTERS POINT SHIPYARD
POST-EXCHANGE TRUST
LAND CONFIGURATION**

POST-EXCHANGE TRUST
 LAND CONFIGURATION

0 500 1000
 S&B DESIGN GROUP
 1/17/06



-  Residential
-  Mixed Use
-  Research & Development
-  Open Space

 Potential Community Sites
 Note that the precise location of these sites may be refined as Phase I is implemented.

Phase 1 Land Use Plan

November 18, 2003

ATTACHMENT 3

FORM OF QUITCLAIM DEED

Recording Requested By:

Redevelopment Agency of the
City and County of San Francisco

When Recorded Mail To:

Lennar/BVHP Partners
[address]

Mail Tax Statements To:

Same as above

This document is exempt from payment of
a recording fee pursuant to Government Code
Section 2738

Space Above Line Reserved for Recorder's Use

QUITCLAIM DEED

FOR VALUABLE CONSIDERATION, receipt of which is hereby acknowledged, the REDEVELOPMENT AGENCY OF THE CITY AND COUNTY OF SAN FRANCISCO, a public body, corporate and politic, of the State of California (the "Agency"), does hereby quitclaim to LENNAR/BVHP, LLC, a California limited liability company doing business as Lennar/BVHP Partners ("Transferee"), all of the Agency's right, title and interest in and to the real property in the City and County of San Francisco, State of California (the "City"), more particularly described on the attached Exhibit A and incorporated by this reference (the "Property").

SUBJECT, however, to: (a) the Disposition and Development Agreement between the Agency and Transferee dated _____, 2003, and recorded on _____, 200_ as Document No. _____ in the Official Records of the City, as amended from time to time (the "DDA"); (b) the Redevelopment Plan prepared by the Agency and approved by the City, acting through its Board of Supervisors, by Ordinance No. _____ adopted on July 14, 1977 and recorded on _____, _____ as Document No. _____ in the Official Records of the City, as amended from time to time (the "Redevelopment Plan"); (c) the Declaration of Restrictions [describe], and recorded on _____, _____ as Document No. _____ in the Official Records of the City, as amended from time to time (the "Declaration of Restrictions); and (d) the exceptions, covenants, conditions and restrictions listed on the attached Exhibit B and incorporated by this reference.

The Agency and Transferee have executed this Quitclaim Deed as of _____, 200_.

Authorized by Agency Resolution
No. ____ adopted _____

REDEVELOPMENT AGENCY OF THE CITY
AND COUNTY OF SAN FRANCISCO, a public
body, corporate and politic

Form Approved:

By _____
Deputy Executive Director

Agency General Counsel

By _____
Secretary

Agency Development Services Division
Approval:

Development Services Manager

TRANSFeree ACCEPTANCE:

Transferee hereby acknowledges and accepts the terms and conditions subject to which the Agency is transferring the Property.

LENNAR/BVHP, LLC,
a California limited liability company

By: Lennar Southland, LLC, a California limited
liability company, its managing member

By: _____
Its: _____

EXHIBIT A
LEGAL DESCRIPTION

EXHIBIT B

EXCEPTIONS, COVENANTS, CONDITIONS AND RESTRICTIONS

[Track DDA re exceptions, covenants , conditions and restrictions, including without limitation nondiscrimination, permitted uses, the Agency's reversionary rights and the like.]

ATTACHMENT 4

SHORT TERM LICENSE AGREEMENT

This Short Term License Agreement (the "Agreement") is made as of _____, 200__ (the "Effective Date"), between the Redevelopment Agency of the City and County of San Francisco, a public body corporate and politic (the "Agency") and Lennar/BVHP, LLC, a California limited liability company doing business as Lennar/BVHP Partners ("Licensee").

Section 1. Recitals.

A. The Agency and Licensee entered into a Disposition and Development Agreement dated as of _____, 2003 (as amended from time to time, the "DDA"). Terms not defined in this Agreement have the meanings given to them in the DDA.

B. Under the DDA, Licensee is required to construct certain Infrastructure, as defined in the DDA, on both (i) the Project Site, as defined in the DDA, which is owned by Licensee, and (ii) the Agency Parcels, as defined in the DDA and more particularly described in the attached Exhibit A (the "Property"), which is owned by the Agency.

C. Licensee desires to enter the Property in order to construct the Infrastructure as required by, and subject to the terms of, the DDA. The Agency is willing to grant a license to Licensee for such purposes on the terms and conditions set forth in the DDA and in this Agreement.

THEREFORE, the parties agree as follows:

Section 2. License to Enter. The Agency hereby grants to Licensee, its contractors, agents and other duly authorized representatives a license to enter upon and use the Property solely for the purposes of constructing the Infrastructure and subject to all of the terms and conditions set forth in the DDA and in this Agreement.

Section 3. Term. The license granted by this Agreement shall be for a term beginning on the Effective Date and ending as to a particular Agency Housing Parcel, Community Facility Parcel or Open Space parcel (all as defined in the DDA) on the date the Agency issues a Certificate of Completion on that particular parcel, unless sooner terminated as provided in Section 13 below.

Section 4. Condition of Property.

(a) No Agency Representations. The Agency shall have no duty to inspect the Property and no duty to warn any person of any latent or patent defect, condition or risk that may exist in or on the Property or that might be incurred in the exercise of the rights granted herein.

(b) Licensee's Inspection and Acceptance. Licensee has made, or before using the Property will make, its own tests and inspections to determine the suitability of the Property for the purposes of Licensee's use hereunder. Licensee hereby accepts the Property "AS IS."

Section 5. Use and Care.

(a) Permitted Use. During the term of this Agreement, Licensee shall use the Property only for the purpose of constructing the Infrastructure and for no other use or purpose whatsoever.

(b) Government Permits. Licensee shall obtain, at its sole cost, all governmental permits and authorizations of whatever nature required by any and all applicable governmental agencies for Licensee's use of the Property. If requested Licensee will furnish to the Agency evidence of such permits and authorizations.

(c) Compliance with Laws. Licensee shall not use the Property nor suffer or permit anything to be done in or about the Property that will in any way conflict with any law, statute, zoning restriction, permit, ordinance or governmental law, rule, regulation or requirement of any duly constituted public authority having jurisdiction over the Property (including, without limitation, any Environmental Laws, as defined in the DDA, and the state and federal OSHA) now or hereafter in force, or any conditions, easements or restrictions now or hereafter encumbering the Property. Licensee shall not commit any public or private nuisance or any other act or things that might or would disturb the quiet enjoyment of the Agency or of any occupant of nearby property.

(d) Maintenance and Care. Licensee shall, at its sole cost, maintain the Property in good repair and in a clean, safe and sanitary condition at all times. This obligation shall include, without limitations, the obligation not to permit trash, rubbish or other waste to accumulate on the Property and to dispose of the same in a clean, safe and sanitary manner.

Section 6. Alterations and Improvements. Other than the Infrastructure, Licensee shall not alter, construct, install or place any buildings, structures, fences, signs, exterior lighting or other improvements on, in or about the Property.

Section 7. Utilities. Licensee shall, at its sole cost, determine the availability of and shall cause to be installed on the Property all facilities necessary to supply water, sewage, gas, electric, telephone and/or other utilities and services required in connection with Licensee's operations on the Property. Licensee shall pay all charges for all such utilities and services.

Section 8. The Agency's Right to Enter and Use Property. The Agency and its authorized contractors, subcontractors and representatives shall have the right to use and enter upon the Property, including any improvement thereon, at any time or times during the term of this Agreement and without any hindrance from or liability to Licensee or its employees, agents or contractors: (a) to inspect the Property, the Infrastructure and Licensee's work and operations thereon; (b) to post and maintain such notices on the Property as may be necessary to protect the Agency against loss or liability from mechanic's liens or otherwise; (c) to use the Property for

any purpose that does not unreasonably interfere with Licensee's use thereof; and (d) if Licensee fails to care for the Property properly as provided in this Agreement, to enter the Property and perform such work thereof as the Agency deems necessary for the proper care thereof, and in such event, Licensee agrees to reimburse the Agency upon demand for all costs and expenses incurred for such work.

Section 9. Liens. Licensee shall not suffer or permit to be enforced against the Property, or any part thereof, any mechanics', materialmen's, contractor's or subcontractor's liens or any claim for damage arising from any work performed by or on behalf of Licensee or its contractors, subcontractors or others for whom Licensee is responsible, and Licensee shall pay or cause to be paid all of such liens, claims or demands before any action is brought to enforce the same against the Property. Licensee agrees that the General Indemnity in Section 17 of the DDA from Licensee to the Agency applies to any and all Losses (as defined in the DDA) arising from or as a result of such liens, claims and demands.

Section 10. Indemnification and Waiver. Licensee agrees that the Hazardous Substances Indemnification in Section 7.2 of the DDA and the General Indemnity in Section 17 of the DDA, both from Licensee to the Agency, apply to any and all Losses arising from or relating to any acts or omissions by Licensee relating to the Property under this Agreement, including without limitation any use of the Property by Licensee or its contractors, agents or others for whom Licensee is responsible. Licensee, as a material part of the consideration of this Agreement, waives all claims or demands against the Agency for any loss, damage or injury of Licensee or Licensee's property. In both cases the indemnity excludes, as to any particular Indemnified Party, Losses to the extent caused by the active negligence or willful misconduct of such Indemnified Party

Section 11. Insurance. Licensee shall comply with the insurance obligations attached to the DDA as Attachment 7.

Section 12. Assignability. Because this Agreement grants Licensee only a license to use the Property, Licensee may not assign, encumber or otherwise transfer this Agreement or any interest in it, and Licensee shall not permit the use of the Property, or any part thereof, except in strict compliance with the provisions of the DDA and this Agreement. Any attempt to do any of the foregoing shall be null and void and shall constitute a breach of the Agreement.

Section 13. Termination and Remedies.

(a) Termination. This Agreement and the license granted hereunder shall terminate concurrently with termination of the DDA. In addition, the Agency shall have the right to terminate this Agreement immediately by written notice to Licensee if Licensee breaches any of its obligations hereunder. Licensee acknowledges that this Agreement is solely in the nature of a license and that Licensee has no rights as an owner, purchaser or tenant by virtue hereof. Upon termination of this Agreement, Licensee shall promptly vacate the Property and the Agency may reenter and take exclusive possession thereof and remove all persons and things therefrom, without legal process to the maximum extent permitted by law, or by such legal process as the Agency may deem appropriate.

(b) Remedies. If this Agreement is terminated because of Licensee's breach of any provision hereof, the Agency may seek any remedy available at law or in equity, including but not limited to a suit for damages for any compensable breach or noncompliance with this Agreement or an action for specific performance or injunction. All remedies provided herein or by law or equity shall be cumulative and not exclusive. No termination or expiration of this Agreement shall relieve Licensee of its obligations to perform those acts required to be performed either before or after its termination.

(c) Agency Payment of Claims. In addition to and not in limitation of the Agency's other rights and remedies under this Agreement, if Licensee fails within ten (10) days of a written request from the Agency either (a) to pay and discharge any lien or claim arising out of Licensee's use of the Property as provided Section 9 or (b) to indemnify and defend the Indemnified Parties from and against any Losses as provided above in Section 10, then in any such case the Agency may, at its option, pay any such lien or claim or settle or discharge any action therefor or satisfy any judgment thereon, and all Losses incurred by the Agency in connection with the same shall be paid to the Agency by Licensee upon written demand, together with interest thereon at the highest rate permitted by law from the date incurred or paid until repaid, and any default either in such initial failure to pay or subsequent repayment to the Agency shall at the Agency's option constitute a breach under this Agreement.

Section 14. Restoration and Removal. Subject to Section 6 above, Licensee shall, at its sole expense, within not more than ten (10) days after the termination of this Agreement (a) remove from the Property all lumber, materials, equipment, and similar items stored or placed thereon by Licensee, its contractors, subcontractors or others for whom it is responsible, and (b) restore the Property to a clean and orderly condition. Such removal and restoration shall include, without limitation, the filling in all temporary excavations, removing from the Property all rubbish and debris, and leaving the Property free and clear of liens.

Section 15. Miscellaneous and Procedural.

(a) Notices. All notices or communications under this Agreement shall be governed by the provisions for notices in Section 22.2 of the DDA.

(b) Recording. Neither this Agreement nor any memorandum hereof shall be recorded in any public office and any attorneys' fees or other costs incurred in clearing such a cloud on title to the Property shall be Licensee's responsibility.

(c) Attorney's Fees. Provisions for attorneys' fees under this Agreement shall be governed by Section 22.6 of the DDA.

(d) Interpretation. Interpretation of this Agreement shall be governed by Section 1.2 of the DDA.

(e) Modification. Any modification or waiver of any provision of this Agreement or any amendment to it must be in writing and signed by a person having authority to do so, on behalf of both the Agency and Licensee.

(f) Successors and Assigns/No Third Party Beneficiaries. Subject to the provisions of Section 12, this Agreement shall be binding upon and inure to the benefit of the successors and assigns of the Agency and Licensee, and where the term "Agency" or "Licensee" is used in this Agreement, it shall mean and include their respective successors and assigns. This Agreement is made and entered into only for the protection and benefit of the parties and their successors and assigns. Except as expressly provided otherwise in this Agreement, as, for instance in regard to the City, no other person shall have or acquire any right or action of any kind based upon the provisions of this Agreement.

(g) Authority and Enforceability. Licensee and the Agency each represents and warrants to the other that the execution and delivery of this Agreement, and the performance of its respective obligations hereunder, have been duly authorized by all necessary action on its part, will not conflict with, result in any violation of, or constitute a default under, any provision of any agreement or other instrument binding upon or applicable to it, nor of any present law or governmental regulation or court decree binding upon or applicable to it.

(h) Counterparts. This Agreement may be executed in counterparts, each of which shall be deemed to be an original, and such counterparts may be assembled to form a single document.

(i) DDA Controls. In the event of a conflict between this Agreement and the DDA, the DDA will control.

The Agency and Licensee have executed this Agreement as of the Effective Date.

Authorized by Agency Resolution
No. _____, adopted _____, _____

AGENCY:
Redevelopment Agency of the City and
County of San Francisco

APPROVED AS TO FORM:

By _____
James Morales,
Agency General Counsel

By: _____
[Executive Director]
By: _____
[Secretary]

LICENSEE:

LENNAR/BVHP, LLC, a California limited liability company

By: Lennar Southland I, Inc., a California limited liability company, its managing member.

By: _____

Its _____

EXHIBIT A

LEGAL DESCRIPTION

REC'T # 0002336074
November 21, 2003 16:02:30

San Francisco Assessor-Recorder
Habel S. Teng, Assessor-Recorder

Document # 03-H595997-00
REEL 1519 IMAGE 1666
Account Number 26
SFDC Redevelopment Agency
Free Issue

Total fee \$0.00
Amount Tendered... \$0.00
Change \$0.00
Rec'd ER/4

DUPLICATE

QUANT TO
SECTION 27383
HEN

the City
o
102
vices

CONFORMED COPY of document recorded on,

as No. 11/21/2003, 2003H595997
This document has not been
SAN FRANCISCO ASSESSOR-RECORDER

(Space above the line reserved for Recorder's Use)

DECLARATION OF RESTRICTIONS

HUNTERS POINT SHIPYARD REDEVELOPMENT PROJECT AREA

This Declaration of Restrictions ("Declaration") is executed by the Redevelopment Agency of the City and County of San Francisco, a public body corporate and politic under the laws of the State of California ("Redevelopment Agency") in reference to the facts and circumstances set forth below.

1. **Property Subject to this Declaration.** The Board of the Supervisors of the City and County of San Francisco ("Board of Supervisors") established the Redevelopment Project Area described in the Hunters Point Shipyard Redevelopment Plan ("Redevelopment Plan") by the adoption of Ordinance No. 285-97 on July 14, 1997, which was recorded with the Redevelopment Plan in the Office of the Recorder of the City and County of San Francisco ("Recorder") on November 21, 2003 as Document No. 2003-H595996 and is incorporated by this reference as a part of this Declaration. The real property subject to this Declaration is the Hunters Point Shipyard Redevelopment Project Area located in the City and County of San Francisco, and is more particularly described in Attachment I of the Redevelopment Plan or pursuant to any Redevelopment Plan amendment hereafter approved ("Plan Area").

2. **Notice of Restrictions.** The Community Redevelopment Law, codified as California Health & Safety Code §§ 33000 et seq. (the "CRL"), requires adequate safeguards to be imposed so that redevelopment will be carried out in accordance with the Redevelopment

Plan and the retention of controls and the establishment of restrictions and covenants running with the land. This Declaration provides record notice that properties in the Project Area are subject to the Redevelopment Plan and the restrictions, reservations and covenants set forth below (the "Restrictions") for the benefit of the Project Area and the Redevelopment Plan, to ensure that each parcel of real property in the Project Area is held, transferred, sold, conveyed and developed subject to the Restrictions.

3. **Nondiscrimination Provisions.** There shall be no discrimination or segregation based upon race, color, creed, religion, sex, gender identity, sexual orientation, age, marital or domestic partner status, national origin or ancestry, or disability, including HIV/AIDS status, in the sale, lease, sublease, transfer, use, occupancy, tenure or enjoyment of any property in the Project Area.

4. **Duration of Restrictions.** Except for Section 3 which will remain in effect in perpetuity, these Restrictions run with the land and apply to and bind all real properties in the Project Area as well as their owners and their successors-in-interest and assignees until the latest of the following: the termination on July 15, 2096 of the Redevelopment Plan adopted on July 14, 1997 by Ordinance No. 285-97, or any later date to which the Redevelopment Plan is extended by the Board of Supervisors; provided, however these Restrictions shall be deemed automatically extended for a term of ten (10) years after the termination of the Redevelopment Plan unless an instrument signed by a majority of the owners of real property in the Project Area agreeing to modify these Restrictions has been first submitted to and approved by the Redevelopment Agency and recorded with the Recorder.

5. **Foreclosure and Enforcement of Liens.** The provisions of this Declaration do not create, limit or expand the right of any mortgagee or obligee ("Obligee") to foreclose or otherwise enforce any mortgage, deed of trust or other encumbrance upon property in the Project Area or the right of an Obligee to pursue any remedies for the enforcement of any pledge or lien upon real property in the Project Area; *provided, however*, that in the event of a foreclosure sale under any mortgage, deed of trust or other lien or encumbrance, or a sale pursuant to any power of sale contained in any mortgage or deed of trust, the purchaser or purchasers, their successors and assigns and the property will continue to be subject to all of the Restrictions and the Redevelopment Plan.

6. **Amendments.** If the Redevelopment Plan is amended in any manner permitted by the CRL after the date on which this Declaration is recorded with the Recorder, this Declaration will be deemed to be automatically amended to incorporate the amended Redevelopment Plan on the effective date of the amendment to the Redevelopment Plan, whether or not such amendment or amended Redevelopment Plan is recorded with the Recorder.

7. **Dissolution.** If the Redevelopment Agency is dissolved or its designation changed by or pursuant to law before completing the Redevelopment Plan, its powers, duties, rights, and functions under this Declaration will be transferred by or pursuant to any applicable provisions of law.

8. **Severability of Provisions.** If any provision of this Declaration or the application of any provision to any real property, real property owner(s) is held invalid by a final judgment of any court, the remainder of this Declaration will remain valid and continue to apply to real properties and property owners in the Project Area.

IN WITNESS WHEREOF, the undersigned has executed this instrument on behalf of the Redevelopment Agency of the City and County of San Francisco as of November 21, 2003.

REDEVELOPMENT AGENCY OF THE
CITY AND COUNTY OF SAN FRANCISCO, a
public body, corporate and politic

Approved as to Form:

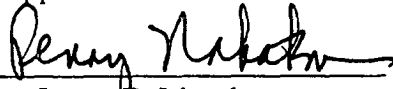
for James B. Morales
Agency General Counsel

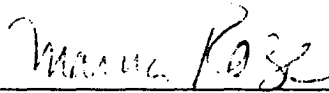
By: 
Marcia Rosen
Executive Director

Attest:

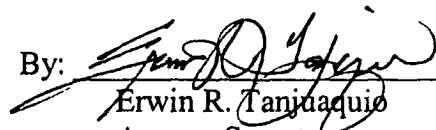
By: 
Erwin R. Tanjaquio
Agency Secretary

STATE OF CALIFORNIA }
 } ss.
COUNTY OF SAN FRANCISCO }

On November 21, 2003, before me, Alma D. Basurto, Notary Public, personally appeared Marcia Rosen and Erwin R. Tanjuaquio, personally known to me (or proved to me on the basis of satisfactory evidence) to be the person(s) whose name(s) is/are subscribed to the within instrument and acknowledged to me that he/she/they executed the same in his/her/their authorized capacity(ies), and that by his/her/their signature(s) on the instrument the person(s), or the entity upon behalf of which the person(s) acted, executed the instrument.

WITNESS my hand and official seal

Signature Alma D Basurto

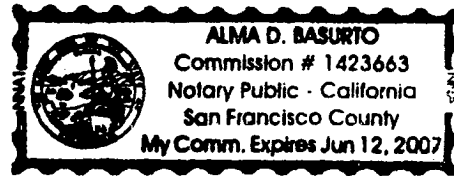

OPTIONAL

Description of Attached Document (HPSY)

Title or Type of Document: Declaration of Restrictions Hunters Point Shipyard and Redevelopment Project Area.

Document Date: November 21, 2003 Number of Pages: 3

Signer(s) Other Than Named Above: N/A

Capacity(ies) Claimed by Signer(s)

Signer's Name: Marcia Rosen

Signer's Name: Erwin R. Tanjuaquio

Title: Executive Director

Title: Agency ^{AS} Assistant Secretary

Signer is Representing:

S.F.R.A.

Right Thumb
Print

Signer Is Representing:

S.F.R.A.

Right Thumb
Print

ATTACHMENT 6

FORM OF REVERSIONARY GRANT DEED

WHEN RECORDED MAIL TO:

Redevelopment Agency of the City and
County of San Francisco
770 Golden Gate Avenue
San Francisco, CA 94102

Parcel _____, Assessor's Block _____, Lot(s) _____

Space Above This Line Reserved for Recorder's Use

Exempt from documentary transfer tax
pursuant to California Revenue and
Taxation Code § 11922.

GRANT DEED

FOR VALUABLE CONSIDERATION, receipt of which is hereby acknowledged, Lennar/BVHP
LLC, a California limited liability company doing business as Lennar/BVHP Partners, hereby
GRANTS to the REDEVELOPMENT AGENCY OF THE CITY AND COUNTY OF SAN
FRANCISCO, a public body, corporate and politic, of the State of California, the real property in the
City and County of San Francisco, State of California, described in the attached Exhibit A.

SUBJECT, however, to: (a) the Disposition and Development Agreement between the Agency and
Transferee dated _____, 2003, and recorded on _____, 200_ as Document No. _____ in
the Official Records of the City, as amended from time to time (the "DDA"); (b) the Redevelopment
Plan prepared by the Agency and approved by the City, acting through its Board of Supervisors, by
Ordinance No. _____ adopted on July 14, 1977 and recorded on _____, _____ as Document
No. _____ in the Official Records of the City, as amended from time to time (the
"Redevelopment Plan"); (c) the Declaration of Restrictions [describe], and recorded on _____,
_____ as Document No. _____ in the Official Records of the City, as amended from time to
time (the "Declaration of Restrictions); and (d) the exceptions, covenants, conditions and restrictions
listed on the attached Exhibit B and incorporated by this reference.

Dated _____
STATE OF CALIFORNIA }
COUNTY of _____ }

Lennar/BVHP LLC, a California limited
liability company

On _____
before me, the understated, a Notary Public in and for said State,
personally appeared _____
personally known to me (or proved to me on the basis of satisfactory
evidence) to be the person(s) whose name(s) is/are subscribed to the
within instrument and acknowledged to me that he/she/they
executed the same.
WITNESS my hand and official seal.

By: _____
Its: _____

Signature _____

Attachment 7

Insurance Requirements

SECTION I. Environmental Insurance.

(A) General. The Parties will reasonably cooperate with each other to obtain environmental insurance providing coverage to the Parties for defense costs and loss associated with third party claims arising from pollution conditions, as well as first party coverage for clean-up costs associated with pollution conditions, as set forth below. Terms used in this Attachment have the meanings set forth in the Disposition and Development Agreement between the Agency and Developer to which this Attachment 7 is attached (the "Agreement").

(1) Parcel A. On or before the Agency accepts title to Parcel A, the Parties will obtain a bound environmental insurance policy providing the above-described coverage to all of Parcel A (not just Parcel A-1) in the amount of 25 million dollars in the aggregate and 25 million dollars per claim, for a fifteen year term, with a deductible requirement of 250 thousand dollars per incident. The Agency will be the First Named Insured, and the Developer will be an Additional Named Insured. The Parties may mutually agree upon conferring Additional Named Insured or Additional Insured status on other related parties.

(2) Parcel A-1. Effective upon the Close of Escrow transferring title of Parcel A-1 from the Agency to Developer, the Parties will obtain endorsements to the above-described environmental insurance policy increasing the policy limit to 50 million dollars in the aggregate and 50 million dollars per incident, and changing the First Named Insured for Parcel A-1 to Developer, with the Agency becoming an Additional Named Insured for Parcel A-1.

(3) Parcel B-1. Effective upon the Close of Escrow transferring title of Parcel B-1 from the Agency to Developer, the Parties will obtain endorsements to the above-described environmental insurance policy increasing the policy limit to 150 million dollars in the aggregate and 50 million dollars per incident.

(4) Order of Conveyance. This Section I(A) assumes that Parcel A will be the first Parcel of the Shipyard conveyed from the Navy to the Agency, and that Parcel A-1 will be the first Parcel conveyed from the Agency to Developer, with Parcel B-1 to follow. If for any reason this order of conveyance is changed, then the Parties will review the insurance requirements in this Section I(A) to determine, in good faith, whether modifications of the insurance requirements are reasonably necessary given the changed order of conveyance. The Parties' intent is for the types of insurance specified in this Section I(A) to be in place when any portion of the Shipyard is conveyed from the Navy to the Agency.

(B) Cost Allocation. The Parties agree to allocate the costs of premiums and deductible payments for the above-described environmental insurance policy as described below. For purpose of this cost allocation agreement, the term "deductible payment" includes costs associated with a claim under the policy that are expended in satisfaction of the deductible requirement pursuant to the terms of the policy.

(1) Initial Premium. Developer is entitled to recover eighty percent of the initial premium amount (and associated brokerage fees and taxes) as described in Section I(A)(1), as a Soft Cost pursuant to the Financing and Revenue Sharing Plan attached as Attachment 25 to the Agreement. The balance of the premium amount (and associated brokerage fees and taxes) will be considered a recoverable cost under Net Operating Income pursuant to the Interim Lease attached as Attachment 29 to the Agreement.

(2) Subsequent Premiums. Developer is entitled to recover one hundred percent of the premium (and associated brokerage fees and taxes) necessary to obtain the increased coverage described in both Sections I (A)(2) and (A)(3) above as a Soft Cost pursuant to Attachment 25.

(3) Deductible During Infrastructure Build-Out. Any deductible payment associated with Parcel A-1 will be considered a Soft Cost pursuant to Attachment 25 during the period Infrastructure is being constructed and Lots are being sold.

(4) Deductible After Infrastructure Build-Out. The following cost allocation will be applied to deductible payments after Infrastructure has been completed and all Lots have been sold, for the respective parcel for which the deductible payments are incurred, during the remainder of the 15-year policy term:

(a) For third party claims, if one Party is named and not the other, that "named" Party will pay the deductible, except to the extent the Party has secured an agreement from other non-Party insureds named in the third party claim to contribute to payment of the deductible.

(b) For third party claims where both Parties are named, each Party shall pay one-half of the amount of the deductible, but the Parties agree to cooperate in good faith to secure contributions, which the Parties will share equally, from other non-Party insureds named in the third party claim.

(c) For first party cleanup claims, the deductible will be paid by the owner of the property for which the cleanup costs will be incurred. If the cleanup costs relate to a plume or other environmental condition that is located on properties owned by different owners, then the affected owners will determine, in good faith, a reasonable allocation of the deductible based on the

cleanup costs reasonably attributable to that portion of the environmental condition on each party's respective property.

(C) Changes. The Parties acknowledge that this agreement to obtain environmental insurance in the manner described above has been informed by the progress made by the Parties prior to execution of the Agreement in mutually agreeing to select Chubb Environmental Solutions as the insurance carrier, and in securing the indication containing premium quotes for various coverage options dated February 4, 2003. The Parties further acknowledge that changes in Chubb's organization in personnel since that time may require the use of another environmental insurer. Even if the insurer is changed, the Parties intend to maintain the agreements, including the coverage limits and policy terms, specified in this Section I. However, the Parties acknowledge that changing the insurer, or other changes in conditions, may require the Parties to determine, in good faith, whether different coverage limits, policy terms and other terms and conditions are reasonably required or appropriate in light of the premium costs and the then insurance market.

SECTION II. Other Insurance.

(A) Developer's Insurance. Developer shall procure and maintain for the duration of the Agreement, including any extensions (and, for completed operations and errors and omissions insurance, for the additional periods specified), insurance against claims for injuries or death to persons or damages to property which may arise from or in connection with the Agreement and the performance of any work pursuant to the Agreement by Developer, its agents, representatives, employees, contractors or subcontractors.

(1) Minimum Scope of Insurance. Coverage shall be at least as broad as:

(a) Insurance Services Office Commercial General Liability coverage (occurrence form CG 0001);

(b) Insurance Services Office form number CA 00 01 covering Automobile Liability, code 1 (any auto); and

(c) Workers' Compensation insurance as required by the State of California and Employers Liability insurance.

(2) Minimum Limits of Insurance. Developer shall maintain limits no less than:

(a) General Liability: \$25,000,000 combined single limit per occurrence for bodily injury, personal injury and property damage. If Commercial General Liability Insurance or other form with a general aggregate limit is used, either the general aggregate limit shall apply separately to Phase 1 or the general aggregate limit shall be twice the required occurrence limit;

(b) **Automobile Liability:** \$10,000,000 combined single limit per accident for bodily injury and property damage; and

(c) **Workers' Compensation and Employers Liability:** Workers' Compensation limits as required by the State of California and Employer's Liability limits of \$2,000,000 per accident for bodily injury or disease.

(3) **Deductibles and Self-Insured Retentions.** Any deductibles or self-insured retentions must be declared to and approved by the Agency. At the Agency's option, either the insurer shall reduce or eliminate such deductibles or self insured retention(s) as respects the Agency, the City and their respective Commissioners, Supervisors, officers, agents and employees, or Developer shall procure a bond guaranteeing payment of losses and related investigations, claim administration and defense expenses.

(4) **Other Insurance Provisions.** The policies are to contain, or be endorsed to contain, the following provisions:

(a) **General Liability and Automobile Liability Coverages:**

(i) The Agency, the City and their respective Commissioners, Supervisors, officers, agents and employees are to be covered as insureds as respects: liability arising out of activities performed by or on behalf of Developer, products and completed operations of Developer, premises owned, occupied or used by Developer, or automobiles owned, leased, hired or borrowed by Developer. The coverage shall contain no special limitations on the scope of protection afforded to the Agency, the City and their respective Commissioners, Supervisors, officers, agents and employees;

(ii) Developer's insurance coverage shall be primary insurance as respects the Agency, the City and their respective Commissioners, Supervisors, officers, agents and employees. Any insurance or self-insurance maintained by the Agency, the City and their respective Commissioners, Supervisors, officers, agents or employees shall be excess of Developer's insurance and shall not contribute with it;

(iii) Any failure to comply with reporting provisions of the policies shall not affect coverage provided to the Agency, the City and their respective Commissioners, Supervisors, officers, agents or employees; and

(iv) Developer's insurance shall apply separately to each insured against whom claim is made or suit is brought, except with respect to the limits of the insurer's liability.

(b) **Worker's Compensation and Employers Liability Coverage.** The insurer shall agree to waive all rights of subrogation against the Agency, the City and their respective Commissioners, Supervisors, officers,

agents and employees for losses arising from work performed by or for Developer.

(c) All Coverages. Each insurance policy required by this Section II shall be endorsed to state that coverage shall not be suspended, voided, canceled by either party, or reduced in coverage or in limits, except after thirty (30) days' prior written notice by certified mail, return receipt requested, has been given to the Agency.

(2) Increases. Not more often than every five (5) years and upon not less than sixty (60) days prior written notice, the Agency may require Developer to increase the insurance limits set forth above if the Agency finds in its reasonable judgment that it is the general commercial practice in San Francisco to carry insurance in amounts substantially greater than those amounts carried by Developer with respect to risks comparable to those associated with Developer's activities.

(3) Acceptability. Insurance is to be placed with insurers with a current A. M. Best's rating of no less than A:VII, unless otherwise approved by the Agency.

(4) Verification of Coverage. Developer must furnish the Agency with certificates of insurance and with original endorsements evidencing coverage required by this Section II. The certificates and endorsements for each insurance policy are to be signed by a person authorized by that insurer to bind coverage on its behalf. The certificates and endorsements may be on forms provided by the Agency. All certificates and endorsement are to be received and approved by the Agency before work commences. The Agency reserves the right to require complete, certified copies of all required insurance policies, including endorsements demonstrating the coverage required by these specifications at any time.

B. Contractor's Insurance. Developer shall cause its contractors, subcontractors and design professionals to have insurance coverage of the types and amounts (and as to contractors and subcontractors, performance and completion bonds) reasonably determined by the Agency and Developer, given the contractor's, subcontractors or design professional's scope of work, the then insurance markets and the Additional Business, Employment, Construction Assistance/Opportunities and Community Benefits Program set forth in Exhibit B of Attachment 24 attached to the Agreement. For design professionals, this will include Professional Errors & Omissions Liability Insurance, which will be in effect for the duration of the applicable statute of limitations (or such shorter period as the Agency and Developer determine is commercially reasonable given the then insurance market) and the retroactive date of which will precede the date services were first performed by the design professional under its scope of work. With respect to general liability coverage, Developer will utilize a General Liability Owner Consolidated Insurance Program ("OCIP") as a single wrap-up

insurance program covering Developer and its related entities, and eligible and enrolled contractors and subcontractors, as described in the document appended to this Attachment 7 entitled *General Liability Owner Consolidated Insurance Program "OCIP) Lennar Corporation – Western Region*. Bonding requirements will incorporate the Agency's Surety Bond Program, and Developer's supplement thereto under Exhibit B of Attachment 24.

DUPLICATE

GUARANTY AGREEMENT

THIS GUARANTY AGREEMENT (this "Guaranty") dated as of December 2, 2003, is made jointly and severally by LENNAR CORPORATION, a Delaware corporation ("Lennar Corporation"), and LNR PROPERTY CORPORATION, a Delaware corporation ("LNR Property Corporation") (Lennar Corporation and LNR Property Corporation are collectively and individually referred to herein as "Guarantor"), to and for the benefit of the REDEVELOPMENT AGENCY OF THE CITY AND COUNTY OF SAN FRANCISCO (the "Agency"). Unless otherwise defined in this Agreement, all initially capitalized terms used in this Agreement shall have the meanings given to them in the DDA (as described in Paragraph A of the Recitals, below).

THIS GUARANTY is made with reference to the following facts and circumstances:

A. The Agency and Lennar/BVHP, LLC, a California limited liability company doing business as Lennar/BVHP Partners (the "Developer" and the "Obligor"), are entering into a Disposition and Development Agreement for Hunters Point, Phase 1 (including all Attachments thereto, and as amended from time to time, the "DDA").

B. Guarantor will derive material financial benefit from the DDA. As an essential inducement for the Agency to enter into the DDA, the Guarantor is entering into this Guaranty, under which Guarantor agrees to guaranty payment and performance of Developer's obligations under the DDA.

ACCORDINGLY, in consideration of the matters described in the above Recitals, and for other good and valuable consideration, the receipt and sufficiency of which are mutually acknowledged, the Guarantor agrees as follows:

1. Guaranty

1.1 Guaranty of Obligations. Guarantor unconditionally and irrevocably guarantees to the Agency the due and punctual payment (and not merely the collectibility) and performance of the Guaranteed Obligations (as defined in Section 1.2 below), as and when the same shall become due and/or payable, on the terms provided in this Guaranty. In addition, Guarantor shall pay, and upon the Agency's request shall promptly reimburse the Agency for, all costs and expenses (including, without limitation, collection charges and Attorneys' Fees and Costs, as defined in Section 8.8 below) incurred by the Agency (collectively, the "Reimbursement Amount") in connection with the enforcement of the Agency's rights, powers, or remedies under this Guaranty, whether or not suit is brought. Any delinquent payment for the Guaranteed Obligations and the Reimbursement Amount shall be accompanied by interest on such amounts at the lesser of ten percent (10%) per annum or the maximum amount permitted by law, from the date due through and including the date of payment of such amounts (calculated on the basis of a 365-day year for the actual number of days elapsed). Guarantor's guaranty of payment of the Guaranteed Obligations shall be discharged and satisfied only as provided in Section 6 relating to termination of this Guaranty.

1.2 Definition of Guaranteed Obligations. For purposes of this Guaranty, "Guaranteed Obligations" shall mean all of the obligations of Developer under the DDA, including all Attachments thereto.

1.3 Acknowledgments by Guarantor. Guarantor acknowledges, confirms, and agrees that: (a) it has received fair and adequate consideration for its execution of this Guaranty; (b) it will derive material financial benefit from the Agency's execution of the DDA; (c) the Agency's agreement to enter into the DDA and take the actions required in connection with the DDA are in consideration of, and in reliance upon, the Guarantor's execution and delivery of this Guaranty; and (d) there are no conditions to the full effectiveness of this Guaranty other than those expressly set forth in this Guaranty.

1.4 Independent Obligations; Continuing Guaranty. This Guaranty is a primary and original obligation of Guarantor and is an absolute, unconditional, continuing and irrevocable guaranty of payment and of performance.

2. Indemnity

2.1 Indemnity. Guarantor agrees to indemnify, defend and hold the Agency, the City and County of San Francisco (the "City") and their respective commissioners, supervisors, officers, agents, employees, attorneys, contractors and lenders (collectively, the "Indemnified Parties") harmless from and against any and all liabilities, losses, damages, liens, obligations, interest, injuries, penalties, fines, lawsuits or other proceeding, judgments and awards and costs of any kind or nature whatsoever (including, without limitation, Attorneys' Fees and Costs as defined in Section 8.8) arising from any investigative, administrative or judicial proceeding, that may be imposed on, incurred by or asserted against any such Indemnified Party, in any manner relating to or arising out of or in connection with the payment or enforcement of this Guaranty (collectively, the "Indemnified Liabilities"). Guarantor agrees to defend the Indemnified Parties against any claims that are actually or potentially within the scope of the indemnity provisions of this instrument, even if such claims may be groundless, fraudulent or false.

2.2 Notice. Each Indemnified Party agrees to give prompt notice to Guarantor with respect to any suit or claim initiated or threatened against the Indemnified Party, at the address for notices of Guarantor set forth in this Guaranty, and in no event later than the earlier of (a) ten (10) days after valid service of process as to any suit or (b) fifteen (15) days after receiving written notification of the filing of such suit or the assertion of such claim, which the Indemnified Party has reason to believe is likely to give rise to a claim for indemnity hereunder. If prompt notice is not given to Guarantor, then Guarantor's liability hereunder shall nevertheless continue, except to the extent, and only to the extent, Guarantor can show that failure to give timely notice prejudiced the Guarantor. The Guarantor shall, at its option but subject to the reasonable consent and approval of the Indemnified Party, be entitled to control the defense, compromise or settlement of any such matter through counsel of the Guarantor's own choice; provided, however, that in all cases the Indemnified Party shall be entitled to participate in such defense, compromise, or settlement at its own expense, and no such settlement shall result in any liability of, or continuing obligations imposed on, any Indemnified Party. If the Guarantor shall fail, however, in the Indemnified Party's reasonable judgment, within a reasonable time following notice from the Indemnified Party alleging such failure, to take reasonable and appropriate action to defend, compromise or settle such suit or claim, the Indemnified Party shall

have the right promptly to hire counsel at the Guarantor's sole expense to carry out such defense, compromise or settlement, which expense shall be immediately due and payable to the Indemnified Party upon receipt by the Guarantor of a properly detailed invoice therefor.

3. Waivers by Guarantor

3.1 Waivers. Guarantor hereby waives: (a) notice of acceptance of this Guaranty; (b) demand of payment, notice of nonperformance, notice of dishonor, presentation, protest, and indulgences and notices of any kind whatsoever; (c) all right to assert or plead any statute of limitations relating to this Guaranty and the DDA (and Guarantor agrees that any act which shall toll any statute of limitations applicable to the DDA shall similarly operate to toll the statute of limitations applicable to Guarantor's liability hereunder); (d) any right to require the Agency to proceed against Developer or any other person or entity liable to the Agency; (e) any right to require the Agency to pursue any other remedy the Agency may have before proceeding against Guarantor; (f) any right to require the Agency to apply to any default any letter of credit or other security it may hold under the DDA; (g) any right of subrogation and any right to enforce any remedy which the Agency now has or may later have against Developer; (h) any and all right to participate in any letter of credit or other security now or later held by the Agency; and (i) any defense that may arise by the reason of (1) the incapacity, lack of authority, death, disability or other defense of Developer or any other guarantor, (2) the revocation or repudiation of this Guaranty by Guarantor, (3) failure of the Agency to file or enforce a claim against the estate (either in administration, bankruptcy or any other proceeding) of Developer or any others, (4) any election by the Agency in any proceeding instituted under the federal Bankruptcy Code, (5) any borrowing or granting of a security interest under Section 364 of the federal Bankruptcy Code, (6) the Agency's election of any remedy against Guarantor or Developer or both, (7) the Agency's taking, modification, or releasing of any collateral or guaranties, or any failure to perfect any security interest in, or the taking of or failure to perfect any other action with respect to any collateral securing performance of Developer's obligations under the DDA, or (8) any offset by Guarantor against any obligation now or later owed to Guarantor by Developer, it being the intention of this Guaranty that Guarantor remain liable to the full extent set forth in this Guaranty until the full performance by Developer of each and every term, condition and covenant of the DDA to be performed by Developer, notwithstanding any act, omission or thing which might otherwise operate as a legal or equitable discharge of Guarantor. Without limiting the generality of the foregoing, Guarantor expressly waives any and all benefits under California Civil Code Sections 2809, 2810, 2819, 2839, 2845, 2846, 2849, 2850, 2855, 2899 and 3433.

3.2 Waiver of Subrogation. Upon satisfaction in full of all of the Guaranteed Obligations, Guarantor shall be subrogated to the rights of the Agency against the Obligor with respect to the Guaranteed Obligations, and the Agency agrees to take such steps as Guarantor may reasonably request to implement such subrogation (provided Guarantor shall pay the Agency Transaction Costs incurred with respect thereto pursuant to the DDA and that the Agency shall not incur any liabilities in taking any such steps).

4. Consents by Guarantor

4.1 Consents; No Discharge of Obligations. Without releasing, discharging, impairing, or otherwise affecting any obligations of Guarantor under this Guaranty or the validity or enforceability of this Guaranty, the Agency may, by action or inaction, in its sole, absolute

and unlimited discretion and without notice to Guarantor: compromise, settle, extend the time for payment or performance of all or any part of the Guaranteed Obligations; refuse or fail to enforce all or any portion of the Agency's rights, powers or remedies under any of the documents; and deal in all respects with Guarantor as if this Guaranty were not in effect. It is the intent of the parties that Guarantor shall remain liable for the payment and performance of the Guaranteed Obligations and all other obligations guaranteed hereby, notwithstanding any act or thing that might otherwise operate as a legal or equitable discharge of a surety.

4.2 Payments to Other Persons. The Agency shall be under no obligation to marshal any assets in favor of the Guarantor or against, or in payment or performance of, any or all of the Guaranteed Obligations. If all or any part of any payment to or for the benefit of the Agency in respect of the Guaranteed Obligations shall be invalidated, declared to be fraudulent or preferential, set aside, or required for any reason to be repaid or paid over to a trustee, receiver or other person (a "trustee") under any insolvency law or any other law or rule of equity (collectively, "set aside"), to the extent of that payment or repayment, the Guaranteed Obligations (or the part thereof) intended to have been satisfied shall be revived and continued in full force and effect as if that payment had not been made, and Guarantor shall be primarily and jointly and severally liable for that obligation, provided that nothing hereunder shall preclude the Guarantor from obtaining a refund from a trustee.

4.3 Additional Rights. This Guaranty is in addition to, and not in substitution for or in reduction of, any other guaranty by Guarantor or any obligation of Guarantor under any other agreement or applicable law that may now or hereafter exist in favor of the Agency. The liability of Guarantor under this Guaranty shall not be contingent upon the enforcement of any lien or realization upon the security, if any, the Agency may at any time possess with respect to the Guaranteed Obligations.

4.4 Recourse. The Agency shall have the right to seek recourse against Guarantor to the full extent provided for in this Guaranty, which right shall be absolute and shall not in any way be impaired, deferred, or otherwise diminished by reason of any inability of the Agency to claim any amount of such Guaranteed Obligation from Guarantor or Obligor as a result of bankruptcy or otherwise, including, but not limited to, any limitation on the Agency's claim from Guarantor or Obligor under §502(b)(6) of the United States Bankruptcy Code, as amended (11 U.S.C. §502(b)(6)). No election to proceed in one form of action or proceeding, or against any person, or on any obligation, shall constitute a waiver of the Agency's right to proceed in any form of action or proceeding or against other persons unless the Agency has expressly waived that right in writing.

5. Representations and Warranties of Guarantor

5.1 Representations and Warranties. Each Guarantor represents, warrants and covenants that it has full power and authority to execute, deliver and perform its obligations under this Guaranty, and that execution, delivery, and performance has been duly authorized by all requisite action on its part.

5.2 Independent Investigation. Each Guarantor has performed its own independent investigation as to the matters covered by this Guaranty.

6. Termination of Guaranty

Guarantor's liability under this Guaranty shall be discharged and satisfied, and Guarantor shall be relieved of any and all further obligations under this Guaranty, upon the later of (a) termination of the DDA and (b) the full performance by Developer of each and every term, condition and covenant of the DDA to be performed by Developer, together with any and all other amounts payable by Guarantor under this Guaranty (including any Reimbursement Amounts); provided that, no such event shall result in termination of this Guaranty unless and until the expiration of any further period within which a trustee or other similar official in an action under any insolvency law may avoid, rescind, or set aside any payment of any of the Guaranteed Obligations. Upon Guarantor's request the Agency will confirm in writing the fact of termination of this Guaranty if this Guaranty has terminated.

7. Notices

A notice or communication under this Guaranty by either party to the other shall be sufficiently given or delivered if dispatched by hand or by registered or certified mail, postage prepaid, addressed as follows:

- (i) In the case of a notice or communication to the Agency:

San Francisco Redevelopment Agency
770 Golden Gate Avenue
San Francisco, California 94102-3102
Attn: Executive Director
Facsimile: (415) 749-2575

with a copy to:

San Francisco Redevelopment Agency
770 Golden Gate Avenue
San Francisco, California 94102-3102
Attn: Legal Division
Facsimile: (415) 749-2575

(ii) And in the case of a notice or communication sent to Guarantor:

c/o Lennar Partners
18401 Von Karman, Suite 540
Irvine, California 92612
Attn: Hunters Point Asset Manager
Facsimile: (949) 442-6175

And to:

c/o Lennar Partners
18401 Von Karman, Suite 540
Irvine, California 92612
Attn: General Counsel
Facsimile: (949) 442-6175

For the convenience of the parties, copies of notice may also be given by facsimile.

Every notice given to a party hereto, pursuant to the terms of this Agreement, must state (or must be accompanied by a cover letter that states) substantially the following:

- (a) the Section of this Agreement pursuant to which the notice is given and the action or response required, if any;
- (b) if applicable, the period of time within which the recipient of the notice must respond thereto;
- (c) if approval is being requested, shall be clearly marked "Request for Approval under the Hunters Point Guaranty Agreement"; and
- (d) if a notice of a disapproval or an objection which requires reasonableness, shall specify with particularity the reasons therefor.

Any mailing address or facsimile number may be changed at any time by giving written notice of such change in the manner provided above at least ten (10) days prior to the effective date of the change. All notices under this Guaranty shall be deemed given, received, made or communicated on the date personal receipt actually occurs or, if mailed, on the delivery date or attempted delivery date shown on the return receipt. A party may not give official or binding notice by facsimile. The effective time of a notice shall not be affected by the receipt, prior to receipt of the original, of a facsimile copy of the notice.

8. General Provisions

8.1 Successors and Assigns. This Guaranty shall be binding upon, and inure to the benefit of, the parties hereto and their respective successors, heirs, administrators and assigns.

8.2 Amendments. This Guaranty may be amended or modified only by a written instrument executed by the Agency and Guarantor.

8.3 Waivers. No action taken pursuant to this Guaranty by the Agency shall be deemed to be a waiver by that party of the Guarantor's compliance with any of the provisions

hereof. No waiver by the Agency of any breach of any provision of this Guaranty shall be construed as a waiver of any subsequent or different breach. No forbearance by the Agency to seek a remedy for noncompliance hereunder or breach by the Guarantor shall be construed as a waiver of any right or remedy with respect to such noncompliance or breach.

8.4 Continuation and Survival of Covenants. All covenants by Guarantor contained herein shall be deemed to be material and shall survive any termination of the DDA or portion thereof if the obligations thereunder have arisen and are not satisfied before such date.

8.5 Governing Law; Selection of Forum. This Guaranty shall be governed by and construed in accordance with the laws of the State of California. As part of the consideration for the DDA, the Guarantor agrees that all actions or proceedings arising directly or indirectly under this Guaranty may, at the sole option of the Agency, be litigated in courts located within the State of California, and the Guarantor expressly consents to the jurisdiction of any such local, state or federal court, and consents that any service of process in such action or proceeding may be made by personal service upon the Guarantor wherever the Guarantor may then be located, or by certified or registered mail directed to the Guarantor at the address set forth in this Guaranty for the delivery of notices.

8.6 Merger of Prior Agreements. The parties intend that this Guaranty and the DDA shall be the final expression of their agreement with respect to the subject matter hereof and may not be contradicted by evidence of any prior or contemporaneous oral or written agreements or understandings. The parties further intend that this Guaranty shall constitute the complete and exclusive statement of its terms and that no extrinsic evidence whatsoever (including, without limitation, prior drafts or changes therefrom) may be introduced in any judicial, administrative or other legal proceeding involving this Guaranty.

8.7 Interpretation of Guaranty. Unless otherwise specified, whenever in this Guaranty reference is made to any Section, or any defined term, the reference shall be deemed to refer to the Section or defined term of this Guaranty. Any reference to a Section includes all subsections and subparagraphs of that Section. The use in this Guaranty of the words "including," "such as" or words of similar import when following any general term, statement or matter shall not be construed to limit such statement, term or matter to the specific items or matters, whether or not language of non-limitation, such as "without limitation" or "but not limited to," or words of similar import, is used with reference thereto, but rather shall be deemed to refer to all other items or matters that could reasonably fall within the broadest possible scope of such statement, term or matter. In the event of a conflict between the Recitals and the remaining provisions of the Guaranty, the remaining provisions shall prevail. Any titles of the several parts and sections of this Agreement are inserted for convenience of reference only and shall be disregarded in construing or interpreting any of its provisions. The terms "Paragraph" and "Section" may be used interchangeably. The masculine, feminine or neutral gender and the singular and plural forms include the others whenever the context requires. Defined terms and variants thereof shall have the same definition. References to days, months and years mean calendar days, months and years unless otherwise specified. References to any law, specifically or generally, will mean the law as amended, supplemented or superseded from time to time. The provisions of this Guaranty shall be construed as a whole according to their common meaning and not strictly for or against either party in order to achieve the objectives and purposes of the parties, regardless of which party drafted this Guaranty.

8.8 Attorneys' Fees and Costs. Should any party institute any action or proceeding in court to enforce any provision hereof or for damages by reason of an alleged breach of any provision of this Guaranty, the prevailing party shall be entitled to receive from the losing party court costs or expenses incurred by the prevailing party including, without limitation, expert witness fees and costs, travel time and associated costs; transcript preparation fees and costs; document copying expenses; exhibit preparation costs; carrier expenses and postage and communications expenses; such amount as a court or other decision maker may adjudge to be reasonable attorneys' fees for the services rendered to the prevailing party in such action or proceeding; fees and costs associated with execution upon any judgment or order; and costs on appeal and any collection efforts (the "Attorneys' Fees and Costs"). For purposes of this Guaranty, the Attorneys' Fees and Costs shall include the fees and costs of in-house counsel for the City, the Agency and the Guarantor based on the fees regularly charged by private attorneys with the equivalent number of years of professional experience in the subject matter area of the law for which the City's, the Agency's or Guarantor's in-house counsel's services were rendered who practice in the City and County of San Francisco in law firms with approximately the same number of attorneys as employed by the City, the Agency or Guarantor.

8.9 Severability. Invalidation of any provision of this Guaranty, or of its application to any person, by judgment or court order, shall not affect any other provision of this Guaranty or its application to any other person or circumstance, and the remaining portions of this Guaranty shall continue in full force and effect, unless enforcement of this Guaranty as invalidated would be unreasonable or grossly inequitable under all the circumstances or would frustrate the purposes of this Guaranty.

8.10 Liability and Tangible Net Worth. The Guaranteed Obligations due and payable hereunder shall be paid on a pro-rata basis by Lennar Corporation and LNR Property Corporation (i.e., Lennar Corporation and LNR Property Corporation will each pay Fifty Cents (\$.50) of every One Dollar (\$1.00)). If at any time during the period this Guaranty is in effect, the aggregate Tangible Net Worth of Lennar Corporation and LNR Property Corporation falls below Four Hundred Million Dollars (\$400,000,000.00), then Guarantor shall notify the Agency as soon as reasonably practicable. Within ten (10) days after delivery of such notice, Guarantor shall provide the Agency with an additional or substitute guaranty in favor of the Agency (in the form of the Guaranty) from a person or entity reasonably acceptable to the Agency having, in the aggregate with all other Guarantors, a Tangible Net Worth of at least Four Hundred Million Dollars (\$400,000,000.00). Further, if at any time during the period this Guaranty is in effect, the Tangible Net Worth of either Lennar Corporation or LNR Property Corporation falls below Two Hundred Million Dollars (\$200,000,000.00), then the relevant entity shall notify the Agency as soon as reasonably practicable. Within ten (10) days after delivery of such notice, the relevant entity shall provide the Agency with an additional or substitute guaranty in favor of the Agency (in the form of the Guaranty) from a person or entity reasonably acceptable to the Agency having, in the aggregate with the relevant entity, a Tangible Net Worth of at least Two Hundred Million Dollars (\$200,000,000.00). Failure to give such notice shall not relieve Guarantor of its obligations hereunder, and failure to provide the additional guaranty(s) required will be a default hereunder. In the event of such default, among the Agency's other legal and equitable remedies, the Agency may require the Guarantor in default to deposit with the Agency an irrevocable, unconditional letter of credit in form and substance, and issued by a financial institution, reasonably satisfactory to the Agency, in the amount of fifty percent (50%) of the then cost to complete the Infrastructure as shown in the then most recent Approved Budget, plus ten percent

(10%) of such amount. The letter of credit will be in effect until the Infrastructure is completed and all costs relating thereto have been paid. The amount of the letter of credit may be reduced from time to time, as agreed upon between Guarantor and the Agency, as the cost to complete declines. The Agency's sole remedy for Guarantor's failure to deposit the letter of credit will be to require Developer to specifically perform, not to seek damages attributable to such failure. However, this limitation on remedies shall apply only to Guarantor's failure to deposit the letter of credit, not to the Agency's rights to enforce the Guaranteed Obligations generally. As used herein: (a) "Tangible Net Worth" means the total assets of Guarantor minus any amounts attributable to (i) goodwill, (ii) intangible items such as unamortized debt discount and expense, patents, trade and service marks and names, copyrights and research and development expenses except prepaid expenses, (iii) reserves not already deducted from assets and (iv) obligations that should, under GAAP, be classified as liabilities on Guarantor's balance sheet, including all indebtedness; and (b) "Lennar Corporation" and "LNR Property Corporation" includes their successors and assigns. No failure or inability of Lennar Corporation or LNR Property Corporation to pay any or all of its portion of the Guaranteed Obligations hereunder shall relieve the other entity of its obligations under this Guaranty.

8.11 Counterparts. This Guaranty may be executed in two or more counterparts, each of which shall be deemed an original, but all of which taken together shall constitute one and the same instrument.

IN WITNESS WHEREOF, Guarantor, being duly authorized, has executed and delivered this Guaranty as of the date first written above.

GUARANTOR

LENNAR CORPORATION,
a Delaware corporation

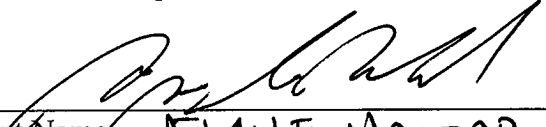
By 
Print Name JENILE HADDAD
Its N.S.

By _____
Print Name _____
Its _____

LNR PROPERTY CORPORATION,
a Delaware corporation

By _____
Print Name _____
Its _____

By _____
Print Name _____
Its _____

[Signatures continue]

GUARANTOR

LENNAR CORPORATION,
a Delaware corporation

By _____
Print Name _____
Its _____

By _____
Print Name _____
Its _____

LNR PROPERTY CORPORATION,
a Delaware corporation

By _____
Print Name **DAVID O. TEAM**
Its **VICE PRESIDENT**

By _____
Print Name _____
Its _____

[Signatures continue]

ACCEPTED AND AGREED:

Authorized by Agency Resolution
No. 179, adopted December 2, 2003

APPROVED AS TO FORM:

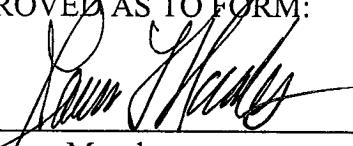
By: 
James Morales,
Agency General Counsel

AGENCY:
Redevelopment Agency of the City and
County of San Francisco

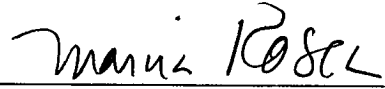
By: 
[Executive Director]

By: 
[Secretary]

ATTACHMENT 9
INFRASTRUCTURE PLAN

**HUNTERS POINT SHIPYARD
PARCEL A' / B'
INFRASTRUCTURE PLAN**

This Infrastructure Plan describes all infrastructure improvements to be provided by Lennar/BVHP for Parcels A' and B'. The initial infrastructure improvements for Parcel A', and the ultimate improvements for parcels A' and B', are described in this document.

This Infrastructure Plan will govern the construction and development of infrastructure in Parcels A' and B', the first Phase of development at the Shipyard ("Phase 1"). The development of Parcels A' and B' will be Phase 1 of the development of the shipyard, and will proceed in two stages as the property is transferred from the Navy. To the extent feasible, the initial stage of construction ("Stage 1") will be limited to Parcel A', and the associated infrastructure will be configured to keep all infrastructure improvements within the Parcel A' boundaries. The second stage ("Stage 2") will include the infrastructure required for the development of Parcel B' and includes modifications to some aspects of the Parcel A' infrastructure, particularly the entrance road configuration and the sanitary and storm sewer connections. The Stage 1 infrastructure will be configured to function independently of any other improvements. During Stage 2 it may be desirable to modify some aspects of the Parcel A' improvements to better accommodate the overall project. The Parcel A' improvements have been designed with enough flexibility to allow conversions as may be determined desirable at some future date. The Infrastructure Plan presented herein is consistent with the Design for Development, the Redevelopment Plan, the FEIR, and the Addendum. Notwithstanding any other provision of this Infrastructure Plan, all activities implementing the Infrastructure Plan shall comply with applicable mitigation measures adopted by the Agency and the City in accordance with the California Environmental Quality Act (CEQA) and applicable laws and regulations.

This Infrastructure Plan describes the general design standards, construction standards, criteria, and specifications of infrastructure in Parcels A' and B' including, without limitations, streets, blocks, lots, wet and dry utilities within the future street right-of-ways, landscaping, open space parcels, and appurtenant infrastructure. The precise locations and final design of infrastructure will be determined by the Department of Public Works (DPW) through the review and approval of applicable subdivision plans, consistent with this infrastructure plan, applicable subdivision laws and codes, and City standards for intersection improvements, street segment improvements, wet and dry utility improvements, open space improvements, and appurtenant infrastructure improvements. Adopted City codes and regulations shall prevail over any conflicting provisions of the Infrastructure Plan.

Appropriate triggers for construction of infrastructure improvements described in this infrastructure plan will be determined prior to signing the DDA.

EXHIBIT A - DEMOLITION AND DECONSTRUCTION

The first item of work associated with the development of Parcels A' and B' will be deconstruction and demolition of existing structures and site features. Items that will be deconstructed / demolished are existing structures, including buildings, an existing water tank, and other existing site features, including pavements, buried utility piping, and other minor structures. To the extent practical, existing structures will be "deconstructed", allowing for maximum re-use of materials. Additionally, for structures that are demolished, materials will be recycled as appropriate.

All deconstruction and demolition activities will be coordinated with Muni prior to construction to ensure that Muni service can be provided on a continuous basis. All work shall be undertaken pursuant to permits issued by the Department of Building Inspection (DBI).

The buildings to be deconstructed / demolished in Parcel A' are primarily wood construction. Additional structures include a five-story reinforced concrete building (formerly the Bachelor Officer's Quarters), a 9,300 square foot building (the Officer's Club), and a 410,000 gallon steel water tank at the top of the Hilltop area. Building 916 (Dago Mary's) is the only building in Parcel A' that will remain.

Buildings that will be deconstructed in Parcel B' are primarily of wood and concrete construction that were formerly used for administration, storage, shops, and a variety of other purposes. Buildings that will remain in Parcel B' during the first Phase of the project include Buildings 103, 104, 115, 116, and 117. Existing buildings in both A' and B' are included in the base wide inventory of existing buildings, building types, and uses is attached as Attachment A. This information is reprinted from a report prepared by FERMA Corporation in 2000, *Demolition / Deconstruction & Rehabilitation Plan and Physical Inspection Report for Hunters Point Shipyard, San Francisco, California, December 30, 2000.*

Building deconstruction / demolition will start with the abatement of hazardous materials including lead paint, asbestos and other hazardous materials to be identified as part of a building survey. Hazardous materials will be abated by encapsulation, removal, and other methods as approved by the Department of Public Health (DPH) and DBI.

Appropriate methods of vector control will be used to mitigate any vermin infestations from the existing buildings.

Building deconstruction will include removal of materials for reuse and/or recycling to the extent feasible. The amount of materials that can be reused or recycled may be limited by the requirements for abatement of hazardous materials.

In addition to the deconstruction / demolition of structures as addressed above, all existing pavements, underground utilities, and overhead utilities in deconstruction / demolition areas will be removed. Concrete and asphalt pavements will be recycled and either used on site or be made available for use elsewhere to the extent feasible. Utility materials, primarily metals, will be recycled as feasible. Where transite pipe (asbestos-cement pipe) is encountered appropriate abatement methods will be used. Removal and disposal of transite pipe material will satisfy applicable requirements.

DRAFT FINAL

As part of a standard grubbing and clearing operation, all trees and other plant materials will be removed from future grading areas. This material will be recycled by composting for on-site uses associated with replanting and erosion control to the extent feasible.

EXHIBIT B - GRADING AND LANDSLIDE REPAIR

Following the deconstruction / demolition of structures in a given area, the grading operation will begin. The removal of pavements, utilities, and clearing and grubbing will begin concurrent with the grading operation. In general the grading will occur in three distinct areas: removal of excavation (cut) from the Hilltop area, placement of fill on the Hillside area, and repair of a landslide that is between parcel A' and existing Building 813. Specific grading and landslide repair will be reviewed by an Engineering Peer Review Panel and approved by DBI during the permit review process. The grading plans for these areas are shown on the attached Figures 1 and 2.

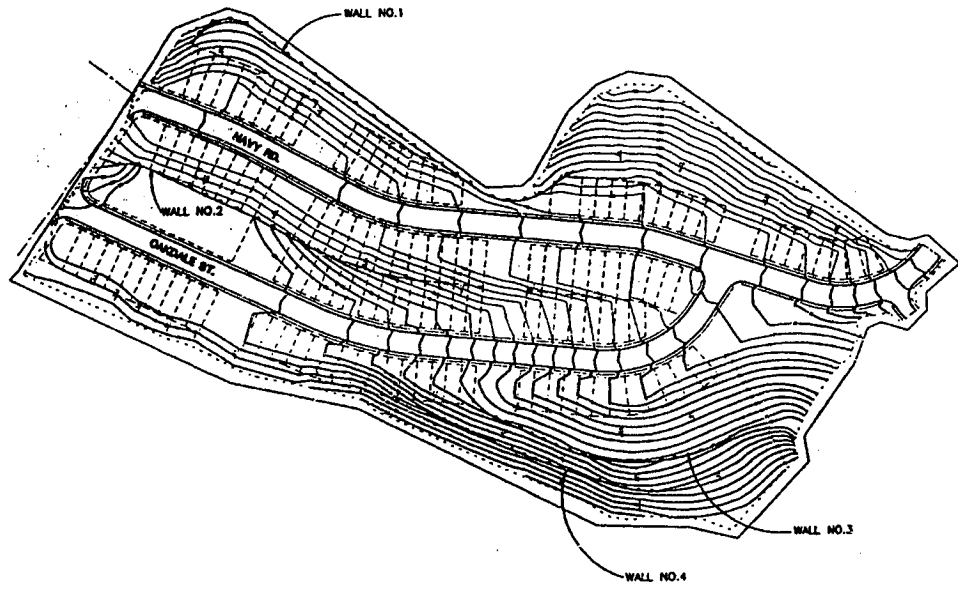

LEGEND

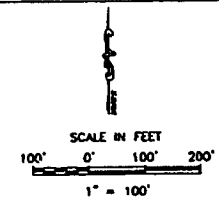
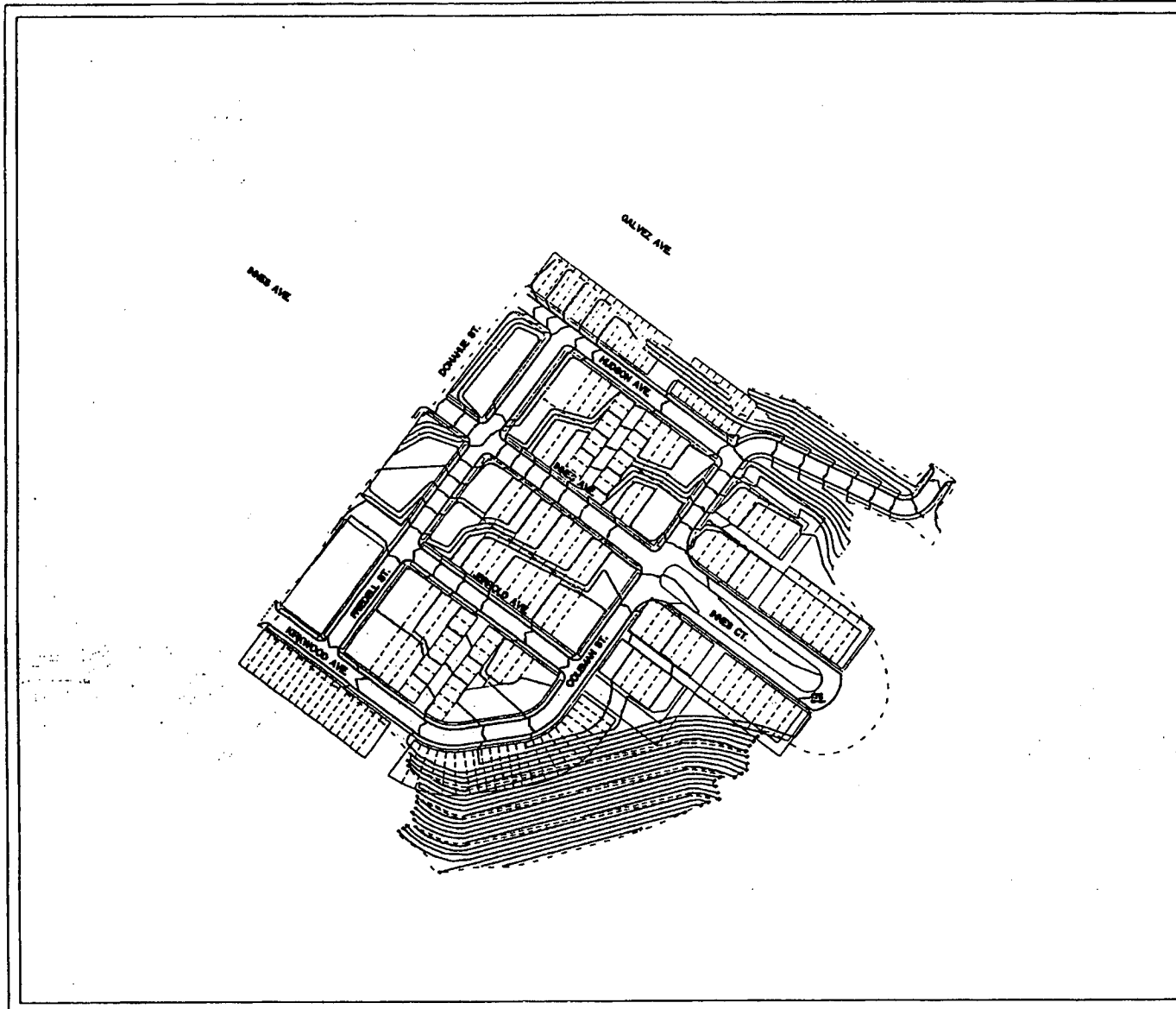

FIGURE 1
GRADING PLAN
HILLSIDE

HUNTERS POINT SHIPYARD DEVELOPMENT PROJECT
PARCEL A' AND B' INFRASTRUCTURE
MARCH 5, 2003



LEGEND

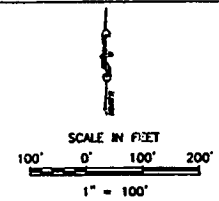

FIGURE 2
 GRADING PLAN
 HILLTOP

HUNTERS POINT SHIPYARD DEVELOPMENT PROJECT
 PARCEL A' AND B' INFRASTRUCTURE
 MARCH 5, 2003

EXHIBIT C - INFRASTRUCTURE WITHIN THE PUBLIC RIGHTS OF WAY

1. Transportation System

Desired service routes will be coordinated with Muni to provide either continued access or approved alternative temporary route during construction.

Off-site transportation improvements as identified in the FEIR are not required during the Phase 1 of the development. Additional studies will be conducted during subsequent phases to determine required off-site transportation improvements to comply with mitigation measures adopted by the Agency in compliance with CEQA.

a. Street System

The street system for Parcel A/B' is shown on the attached Figure 3, including existing and proposed streets. Typical street sections, including basic geometries in the Right-of Ways such as number of lanes, their uses, and their widths are shown on Figure 4. Final street sections and geometries will be reviewed and approved by the City during the review of applicable subdivision plans.

During Stage 1 the roadway configuration at the project entrance will follow the route indicated for Innes/Donahue/Galvez on Figure 5. Following the transfer of Parcel B' the future alignment of the entrance road will be modified to the "S" curve alignment shown on Figure 6.

b. Street Improvements

Street improvements consist of both the construction of new roads and improvements to existing roads. Specific items of work associated with new roadway construction may include demolition of existing pavements, excavation and grading, subgrade preparation, placement of aggregate subbase, placement of aggregate base, paving, signing and striping, construction of concrete curbs and gutters, sidewalk construction, plantings, driveway approaches and transitions, street lights, fire hydrants, bus stops, pedestrian crossings, traffic signals, stop signs, and appurtenant improvements. Improvements to existing roads may include crack sealing, cold planing to conform to existing features, reconstruction of curbs, gutters, and sidewalks, placement of pavement fabric, pavement overlays, signing and striping, and appurtenant improvements. All street improvements will include street landscaping as described in this Infrastructure Plan.

The existing traffic signal at Innes and Donahue will be replaced with a temporary signal system during Stage 1. This signal will be removed during Stage 2, and no traffic signals will be included in the final configuration of Phase 1 development.

Four street structural sections are included in the plans. All structural sections will meet applicable City standards, and will be designed to carry all anticipated loads, including buses. The structural sections will be more accurately defined during final design. All sections will be coordinated with the Design for Development during subsequent levels of design. Final street structural sections will be reviewed and approved by the City during the review of applicable subdivision plans. These sections generally include:

- Major streets, include Innes Avenue in Parcel A' north of Donahue Street; Donahue Street in Parcel A'; and Galvez Avenue. These streets will be two way streets and will include a total of four 12 foot wide traffic lanes, two 5 foot wide bike lanes, and a median with varying widths. The overall paved width for this street section is 58 feet. The proposed structural section for major streets will consist of 5 inches of asphalt concrete (AC) pavement, 8 inches of aggregate base, and 6 inches of aggregate subbase placed over a compacted subgrade.
- Residential streets on the Hilltop include: Kirkwood Avenue; Jerrold Avenue; Innes Avenue south of Donahue and north of Innes Court; Hudson Avenue south of Donahue Street; and Friedell Street. These streets will be two way streets with a paved width of 34 feet. This proposed structural section will consist of 4 inches of asphalt concrete (AC) pavement, 6 inches of aggregate base, and 6 inches of aggregate subbase placed over a compacted subgrade.
- Residential and commercial streets on the Hillside and in Parcel B', include: Fairfax Avenue; Lockwood Avenue; McCann Street; Donahue Street east of Galvez Avenue; Navy Road; and Oakdale Street. These streets will be two-way streets and will include two 12 foot lanes and two 8 foot parking lanes for an overall paved width of 40 feet. This proposed structural section will consist of 4 inches of asphalt concrete (AC) pavement, 6 inches of aggregate base, and 6 inches of aggregate subbase placed over a compacted subgrade.
- One-way streets. The only one-way streets in Phase 1 will be the streets around Innes Court on the Hilltop. These streets will have an overall paved width of 20 feet. This structural section will consist of 4 inches of asphalt concrete (AC) pavement, 6 inches of aggregate base, and 6 inches of aggregate subbase placed over a compacted subgrade.

All anticipated underground infrastructure improvements within the future right-of ways will be constructed prior to placement of the final pavement structural sections and/or overlays.

During Stage 1 temporary improvements will be made to the intersection of Innes Avenue and Donahue Street, including a temporary traffic signal. During Stage 2 the project entrance will be modified to the "S" configuration shown on Figure 6. The signal at Innes and Donahue will be removed during Stage 2, and no other traffic signals will be included in Phase 1. During subsequent Phases of the development, the intersection of Donahue and Galvez will be signalized and off-site improvements will be made at the intersections of Evans and Third and Evans and Caesar Chavez as identified in the FEIR. The roadway improvements associated with Phase 1 of the project are described below.

During the Stage 1 of the development, the Galvez and Donahoe intersection will be reconstructed and improved. The existing intersection includes two lanes in each direction on Innes, and two lanes in each direction on Donahue. This lane configuration

will remain during Stage 1 development however; improvements will be made to both the street geometry and traffic signals.

During Stage 2 of the development (Parcel B'), the current configuration of the entrance roads will be replaced with the "S" curve shown on Figure 4. During this phase of the project, the portions of Innes and Donahue (south of the realigned "S" curve roadway) will be reconstructed to one lane in each direction, and the signals at the intersection at Innes and Donahue will be removed and replaced with traffic control signs.

The proposed alternative will replace the four lane Innes/Donahue legs of the entrance roadway with an "S" curved configuration. Both Innes and Donahue will be rebuilt as two lane roads. Part of this alignment will cross the Parcel A' boundary into Parcel B', necessitating a delay in the construction of the "S" curve roadway until Parcel B' is conveyed.

Construction will occur in two stages. Following the transfer of Parcel A', the initial stage will include repaving, adding curbs and gutters to the existing Innes and Donahue legs, and the demolition and grading of Block 1). Following the transfer of Parcel B', the second stage will include the remainder of the roadway construction (the "S" curve) from Innes to Galvez.

Construction of the Innes / Donahue / Galvez entrance (including infrastructure to and filling of Block 1 will include the following:

Initial Stage (Following transfer of Parcel A')

1. Demolition of the existing curbs, gutters, and sidewalks on Innes from the boundary of Parcel A to the Innes/Donahue Intersection.
2. Demolition of Building 322.
3. Demolition of approximately 1/3 of Hudson Street prior to the filling operation in Block 1.
4. Pavement overlays on both Innes and Donahue.
5. Construction of new curbs, gutters, and sidewalks on Innes.
6. Placement of fill in Block 1 to create a building pad level with Innes.
7. Continued use of the existing traffic signal at Innes/Donahue.
8. Construction of temporary landscaping.
9. Construction of a water main extension in Innes.
10. Construction of joint trench in Innes and Donahue for dry utilities
11. The existing combined sewer in Innes will provide a sanitary sewer connection adequate to serve Block 1. This would be a gravity connection.
12. Construction of a storm drain connection in Donahue and Galvez.

Final Stage (Following transfer of Parcel B')

1. Demolition of the four lane roads in Innes and Donahue Streets that were constructed during Stage 1, including curbs, gutters, and sidewalks.
2. Demolition of remaining 2/3 of Hudson Street.
3. Construction of new two lane roads for Innes and Donahue, including curbs, gutter, and sidewalks.

4. Grading, paving, and curbs, gutters, and sidewalks for the new "S" road alignment.
5. Construction of a new signalized intersection at Donahue/Galvez.
6. Removal of the existing signal at Innes/Donahue.
7. Construction of an extension of Fairfax Street (Required for access to Blocks 2 and 3).
8. Construction of a retaining wall near Dago Mary's.
9. Construction of permanent landscaping.
10. Provide access to the northern part of Block 1 from Innes Avenue via the existing Earl Street Right-of-Way.

Innes Avenue, Donahue Street, and Galvez Avenue will be modified in Phase 1. Modifications will not be required in Earl Street. These modifications are generally indicated on Figures 3 and 4 and will consist of:

(i) Innes Avenue

During Stage 1 of the development, Innes Avenue will receive a pavement overlay, reconstruction of concrete curbs and gutters, improvements to the intersection of Innes and Donahue as previously described, new signing and striping, and construction of sidewalks and landscaping.

During Stage 2, the existing street will be demolished and replaced with a narrower section, with one lane in each direction, including concrete curb and gutter sections, new sidewalks and landscaping, and new signing and striping.

(ii) Donahue Street

During Stage 1 of the development, Donahue Street will receive a pavement overlay, reconstruction of concrete curbs and gutters, improvements to the intersection of Innes and Donahue as previously described, new signing and striping, and construction of sidewalks and landscaping.

During Stage 2, the existing street will be demolished and replaced with a narrower section, with one lane in each direction, including concrete curb and gutter sections, new sidewalks and landscaping, and new signing and striping.

(iii) Galvez Street

Galvez Street will receive a pavement overlay, new signing and striping, and new sidewalks.

All additional street construction will consist of demolition of existing streets and construction of new streets, as shown on Figure 3.

2. Waterfront Improvements

This Infrastructure Plan includes waterfront improvements in Parcel B'. Waterfront improvements will occur during the development of Stage 2. These waterfront improvements will include demolition and restoration of existing waterfront facilities in Parcel B' and development of pedestrian access, open space areas, area lighting, and other amenities such as street furniture. The area that will be developed includes the former submarine Dry Docks No. 5, 6, and 7; and Berths 61, 62, 64, and 65. These dry docks and berths are shown on Figure 3. The existing wooden piers that include Berths 61, 62, and 65 will be demolished. The remainder of the submarine dry docks are in structurally poor condition and will be upgraded to meet current seismic codes. The restoration and development of these features will be for recreational waterfront uses and reviewed and approved by the City during the review of appropriate subdivision plans.

Proposed construction activity in the Waterfront area includes:

- Remove of sunken derelict north of Dry Dock No. 7
- Remove wood-framed dock (Berth No. 64), north of Dry Dock No. 7
- Remove wood framed dock (Berth No. 61) south of Dry Dock No. 5
- Remove debris and old wood piles at mud line between Dry Docks No. 5, 6, and 7
- Remove wood framed end noses at Dry Docks
- Remove corroded cellular steel sheet pilings and displaced earth fill at Breakwater (Berths 62 and 65)
- Add minor deck structures cantilevered from dry dock walls
- Provide timber framed portions of rebuilt dry dock noses
- Clean, prep, and provide 3 inch asphalt overlay over existing concrete pavements. Base repair will be completed prior to paving where required for roadway stability.
- Provide new hand railing, area lighting, and street furniture. Generally, the hand railing will extend along the waterfront and all piers and docks extending into the water. Street furniture will be placed in accordance with the approved landscaping plan for the area.

3. Wet Utilities

All wet utilities (storm drain, sanitary sewer, combined sewer, auxiliary water, potable water, and reclaimed water) will be designed in accordance with the City design Standards for utility construction, included as Attachment B. Final wet utility design will be reviewed and approved by the City during the review of applicable subdivision improvement plans.

The following section describes infrastructure for storm drains, sanitary sewer, combined sewer, and water improvements, which shall, except as otherwise indicated, be provided by Lennar/BVHP in connection with the development of Parcels A' and B'. The construction of wet utility systems in Stage 1 requires that all utility construction remains within Parcel A'; however, the ultimate plans for these systems require construction

outside of the Parcel A' boundaries within Parcel B'. The ultimate wet utility configurations cannot be constructed until Stage 2.

The Stage 1 improvements have been designed to allow for future conversion to the Stage 2 configuration with minimal future disruptions of services.

a. Storm Drainage

The overall layout of the storm drainage system is shown on Figure 10. As indicated, the storm drain and sanitary sewer system for the Hilltop Area and for Parcel B' will be separated systems and the storm drain and sanitary sewer system for Hillside Area will be combined. The separated system is addressed below, and the combined system is addressed under a subsequent heading.

The storm drain system will be constructed in two stages; the first stage serving Parcel A' only, and the second stage serving Parcels A' and B'. The storm drains will conform with the City of San Francisco design standards for storm drains, including the requirement that a 5-year event will be entirely drained by the underground system and a 100-year event will be contained between the faces-of curb within the street right-of-way. Catch basins shall be provided at all low points and shall be located in the gutter to most effectively serve adjacent drainage areas.

The construction of storm drains for the Hilltop Area during Stage 1 will consist of a new gravity system of vitrified clay pipe (VCP) ranging from 12 inches to 24 inches in diameter that will tie into the existing storm drain system at the intersection of Galvez and Donahue. Storm water discharge will then travel downstream through the existing system in Galvez Street, and into Parcel B. The existing system discharges to the Bay through a 36-inch outfall near the extension of Donahue Street. In addition to the construction of new storm drain facilities in Parcel A', the initial phase of construction will also require replacement of approximately 240 LF of existing 15 inch diameter storm drain in Parcel B' (See Figure 10) with 24 inch diameter storm drain. The system downstream from the point of connection at Donahue and Galvez will remain under Navy ownership until Parcel B is transferred, and discharges will be made using the City's municipal discharge permit. Effective upon the transfer of Parcel A, the Shipyard will be added to the City's MS4 permit (adopted April 30, 2003 with the Regional Water Quality and Control Board (RWQCB). Lennar/BVHP will work with the City to develop and implement a site-specific plan under this permit. The current pattern of discharge will be maintained, with runoff discharging directly into San Francisco Bay.

The following drainage easements will be required over Navy property:

Easement A

An easement 10 feet each side of the following storm drain pipes: (1) from a catch basin in front of Building 816 to the connection to the 24 inch diameter storm drain in Crisp Avenue; (2) then along said storm drain in a southeasterly direction in Crisp Avenue to a manhole in front of Building 815; (3) then downstream through the existing system through 24 inch and 48 pipes to the system outfall near Berth 36; (4) from an existing catch basin in front of Building 808, south and west to the point of connection with the above mentioned system.

Easement B

An easement 10 feet each side of the following storm drain pipes: (1) the connections from five storm drains in front of Building 813 to the 18 inch storm drain in Spear Avenue, then easterly along 18 inch and 21 inch storm drains to the boundary of Parcel A-1.

Easement C

An easement 10 feet each side of the following storm drain pipes: (1) the 24 inch storm drain in Spear Avenue from the eastern boundary of Parcel A-1 to the intersection of Spear Avenue and Blandy Avenue; (2) downstream through 27 and 30 inch storm drains in Blandy Avenue to an outfall at Berth No. 5.

Easement D

An easement 10 feet each side of the following pipes: (1) Beginning at a catch basin immediately east of Building 101, through a 27 inch storm drain crossing Robinson Street, and downstream through 27, 30, and 33 inch pipes to an outfall near Building 133.

Easement E

An easement 10 feet each side of the following pipes: (1) A 21 inch storm drain crossing the Parcel A boundary from Galvez Street south of Building 104 in an easterly direction to a manhole near Galvez; (2) 8 inch storm drain pipes and catch basins connecting a catch basin on the east side of Galvez to said manhole; (3) downstream piping to the outfall north of Dry Dock No. 7.

During Stage 2 of the development, the remainder of the new system will be constructed. All stormwater from Parcels A' East and B' will discharge to this new storm drain system. New storm drain pipes up to 36 inches in diameter will be constructed in Donahue Street, and will discharge to the Bay at the existing outfall located at the extension of Donahue Street. The outfall will be at the same location as the existing outfall for Easement E; however, the alignment of the piping upstream from the outfall will be modified, with the 36 inch storm drain in Donahue Street described above. The outfall will be upgraded to 42 inches in diameter, and will flow through a liquid/solid separation system prior to discharge to the Bay. Discharges will continue to be made under the City's municipal permit. Appropriate water quality and best management practices will be included as required by the FEIR and approved by the City.

Storm water runoff from the project will comply with the requirements of the National Pollutant Discharge Elimination System (NPDES). All storm water discharges will be made in accordance with the City and County of San Francisco Initial Storm Water Management Plan 2003-2004, Port Utilities Commission, Port of San Francisco, March 7, 2003. This plan requires:

1. Development and implementation of a Storm Water Management Plan (SWMP) that describes Best Management Practices (BMP), measurable goals, and timetable for implementation of the following six program areas (Minimum Control Measures)

Public Education
Public Participation
Illicit Discharge Detection and Elimination

Construction Site Storm Water Runoff Control
Post Construction Storm Water Management
Pollution Prevention/Good Housekeeping for Municipal Operations

2. Reduce discharge of pollutants to the maximum extent possible
3. Annually report on the progress of SWMP implementation

The storm drainage system and the infrastructure to be constructed by Lennar/BVHP in connection therewith are shown in Figure 10. The storm drainage system will comply with applicable City of San Francisco standards as identified in attachment 2. Applicable design criteria include the following:

- Drainage basins are separate areas with a maximum time of concentration of 20 minutes during a five-year storm event.
- Underground drainage facilities are adequate to completely convey the entire five-year runoff event.
- Runoff events exceeding a five-year event will be carried by surface drainage features. Surface features (i.e., gutters) will have adequate capacity to convey the 100-year event.
- Minimum pipe size for the main storm water trunk lines is 12 inches.
- Pipes up to 27 inches in diameter will be vitrified clay pipe (VCP); pipes greater than 27 inches will be reinforced concrete pipe (RCP).
- Pipes will have a minimum of four feet of cover.
- The drainage system will maintain a minimum velocity of 2.5 ft/sec
- The minimum pipe slope will be 0.2%.

(i) Drainage Basins

The proposed drainage design provides for drainage basins with a 20-minute maximum time of concentration during a five-year event. In addition to the areas encompassed by Parcels A' and B', there are three small drainage basins extending from Friedell Street to Donahue Street that will be served by the existing system.

Portions of the proposed storm drain system will tie to the existing combined sewer system in Donahue Street. Connections to this existing system will be made at the intersections of Donahue Street and LaSalle Avenue and at the intersection of Jerrold Avenue, and Cleo Rand Avenue. It will not be feasible to drain these areas by gravity to the new separated system.

(ii) Liquid/Solid Separator

During Stage 1, the storm drains will be tied to the existing storm drain system and discharges will be made directly to the Bay.

During Stage 2, the outfall discharging to the San Francisco Bay will be upgraded. The location of this outfall is shown on Figure 10. It is anticipated that this improved outfall will require a new discharge permit and will be subject to applicable portions the City of San Francisco General Permit for Storm Water Discharges from Small Municipal Separate Storm Sewer Systems. The system will be designed to comply with all applicable regulatory requirements and mitigation measures. The project will include a vortex-type treatment unit for the separation of floatable materials and settleable solids, as required by the General Permit and in accordance with the National Pollutant Discharge Elimination System (NPDES). This treatment unit will require regular maintenance to remove accumulated debris and solids. The developer, from the time of construction, will provide maintenance for this unit until ownership is transferred to the City under the established acquisition process.

(iii) Particulate Management

Source control measures to remove particulates in runoff from streets and parking lots will be provided as appropriate. Best Management Practices for source control will be developed in cooperation with the City prior to the start of construction. Regular maintenance will be required for the removal of accumulated particulates from the catch basins. The developer, from the time of construction, will perform maintenance until ownership of the storm drains is transferred to the City under the established acquisition process. Following transfer of ownership, the City will perform maintenance.

In accordance with the FEIR, a Storm Water Pollution Prevention Program (SWPPP) will be prepared prior to construction and will include appropriate measures to remove and control particulates in runoff from exposed area during construction. All stages of the development will conform to the City's Storm Water Management Plan.

b. Sanitary Sewer System

The sanitary sewer system will be constructed in two stages. During Stage 1 a gravity system connecting to the existing City system at the intersection of Innes and Donahue will be constructed. This system will consist of 8 inch and 12-inch diameter pipes, and will connect to an existing manhole at the intersection of Donahue and Galvez.

During Stage 2 of the project, sanitary sewers serving Parcel B' will be constructed. This system will consist of 8 inch and 12 inch diameter pipes draining to a pumping station located at the intersection of Lockwood and McCann Streets. The pumping station will discharge to an 8 inch diameter force main that will carry the discharge up Lockwood and Donahue Streets to the existing manhole at the intersection of Innes and Donahue.

The existing sanitary sewer system currently flows to an existing pumping plant near the southwest corner of Parcel A, and is pumped to a point of connection with the existing City system at the intersection of Griffith Street and Crisp Avenue. Previous infrastructure reports have indicated that future sanitary flows from Parcels A/B' would connect to pipelines in McCann, Fisher, Spear, and Crisp, and flow to a new pumping station near the same location as the existing pumping plant at Building 819. The currently proposed configuration can be converted to a configuration discharging to this pump station at some future time if desired. The sanitary sewer system will conform with

City Design Standards included herein as Attachment B, and will be designed based on the following design criteria:

The sanitary sewer system is designed to comply with the Subdivision Regulations of the San Francisco Department of Public Works, Bureau of Engineering, as well as the Standard Specifications dated November 2000 of the Bureau of Engineering, Department of Public Works, City and County of San Francisco.

- All sewers will be located in the public right-of-way or easement.
- In general, all sewer lines shall be 6 inches minimum in diameter for residential districts, and 8 inches minimum in diameter for industrial and commercial districts.
- All pipes will be vitrified clay (VCP; ASTM C-700 Extra Strength).
- VCP sewers will have bell and spigot joints with factory-fabricated compression-type fittings (ASTM C425)
- The minimum depth for sewer pipes is six feet of cover.
- In no case shall the sewer trench be less than 4 feet wide, to distribute surface loads and provide access space for utility providers.
- Sewers may be designed to flow under surcharged conditions.
- All sewers shall generally be laid on straight lines and grades between manholes.
- All VCP sewers on grades of 30 or more percent shall be encased in concrete in accordance with the Standard plans.
- Sewer manholes and junctions shall be placed at intervals not to exceed 350 feet.

Systems will be sized to meet appropriate sanitary sewer flows. Residential sanitary sewer demands are based on 3 persons per unit, 100 gallons per person per day, and a peak factor of 1.8, consistent with the SFPUC. Commercial sanitary sewer demands are based on 100 persons per acre and 100 gallons per capita per day, with a peaking factor of 1.8.

Sewage treatment will be provided by the City of San Francisco. The San Francisco Public Utilities Commission is conducting a study of sewage treatment options for the Shipyard that includes a possible on-site treatment. The Phase 1 sanitary sewer system will be designed to be convertible to either an on-site pumping station or on-site treatment if desired by the City. Any on-site treatment will not be part of the development of Parcels A' or B' and is not a requirement under this Infrastructure Plan.

c. Combined Sewer System

As identified in the FEIR, the Hillside Area will continue to be served by a combined system for both storm drainage and sanitary sewer. This system will consist of new 12inch and 15inch combined sewers in Navy Road, and 8 inch and 15 inch combined sewers in Oakdale Avenue. These two pipelines will meet near the intersection of Griffith Street and Oakdale Avenue and connect to the City combined sewer system at the existing manhole.

The combined sewer system is designed to comply with the Subdivision Regulations of the San Francisco Department of Public Works, Bureau of Engineering, as well as the Standard Specifications dated November 2000 of the Bureau of Engineering, Department of Public Works, City and County of San Francisco. The combined sewer system will be designed to conform to City standards set forth for the sanitary sewer system or to the standards set forth for storm drains, whichever is more stringent. This includes the following provisions:

- All sewers will be located in the public right-of-way or easement areas.
- All combined sewer lines shall be 12 inches minimum in diameter.
- All pipe will be vitrified clay (VCP; ASTM C-700 Extra Strength).
- VCP sewers will have bell and spigot joints with factory-fabricated compression-type fittings (ASTM C425)
- The minimum depth for sewer pipes is six feet of cover.
- In no case shall the sewer trench be less than 4 feet wide, to distribute surface loads and provide access space for utility providers.
- Sewers may be designed to flow under surcharged conditions.
- All sewers shall generally be laid on straight lines and grades between manholes.
- All VCP sewers on grades more than 30 percent shall be encased in concrete in accordance with City Standards.
- Sewer manholes and junctions shall be placed at intervals not to exceed 350 feet.

d. Auxiliary water Supply System (AWSS)

There is no AWSS system currently serving the Hunters Point Shipyard. The Navy has historically depended upon hydrants connected to the potable water system and upon salt water fire protection and distribution systems activated by wharf-side pumps. However, the salt water system has been abandoned and will not be used in the future. Currently fire protection is provided by the potable water system.

Although it is anticipated that the proposed water system will provide adequate pressure, flow, and volume to meet firefighting requirements, Lennar/BVHP will construct a high pressure water system in Innes Avenue from the project boundary to Donahue Street. This connection will consist of approximately 1,280 feet of 20-inch diameter ductile iron pipe in Innes Avenue. This system will be designed by DPW and funded by Lennar/BVHP. The system consists of Ductile Iron Pipe (DIP); high pressure hydrants, valves, and fittings; and appurtenances. A connection to the City AWSS system does not currently exist, and the system may be charged via a connection to the City potable water system on an interim basis. This connection may require positive backflow protection. Offsite improvements to the City's AWSS system are not a requirement of this Infrastructure Plan.

e. Potable Water System

The Hunters Point Shipyard is currently served by the SFPUC through two metering points at Crisp Road (University Mound) and at Jerrold Avenue (Hunters Point

Reservoir). Within the Shipyard, the water distribution system provides both potable and fire protection supply. The water distribution system is in a state of disrepair; with significant portions of the existing system cut, capped, and abandoned. The proposed new water distribution system is described below.

The new potable water system will tie into the City system with metered connections at the property boundary. These connections will be made near the intersection of Innes and Earl; and in Jerrold near Fitch.

Interconnection facilities required by the City, including metering and backflow prevention, will be provided as required. The developer will maintain the system until ownership is transferred to the City according to established acquisition process. Water will be provided by the SFPUC through a 16-inch main from the University Mound storage system, at Innes Street, and a proposed 16-inch main connection to the Hunters Point storage system, at Jerrold Street. These connections will be permanent. The adequacy of the existing facilities to provide the required water supply will be evaluated in cooperation with the SFPUC.

Ultimately, water supply to the Shipyard will be connected to a 16-inch diameter loop in Crisp, Spear, McCann, Donahue, and Innes, which will form the primary system for the Shipyard. The mains for this primary loop are located at the intersections of Crisp Avenue and Pallou Avenue, and at the intersection of Innes Avenue and Fitch Street. The Innes Avenue connection will be made during Stage 1 of the project.

The proposed water system will be designed to accommodate both fire flow demand and potable water demand. Final pipe sizes, locations, connections and interconnections, flows, pressures, location, and number of fire hydrants will be determined using water modeling software (WaterCAD) and appropriate design criteria reasonably established by the City of San Francisco.

As previously indicated, water service will be provided by SFPUC. The University Mound System currently has a storage capacity of 140 million gallons and a static head of 172 feet. The Hunters Point System has a storage capacity of 13.5 million gallons and a static head of 255 feet, and is located in residential area just northwest of the base property. The two pressure zone systems may be designed to allow water from the high-pressure zone to feed the low pressure zone through a flow regulating valve as approved by the City.

The proposed potable water system design will be reviewed and approved by the City during review of applicable subdivision plans.

The water supply and storage systems will be designed to comply with the Standard Specifications, November 2000, by the Bureau of Engineering, Department of Public Works, City and County of San Francisco.

The total maximum water demand includes the fire flow demand and the peak daily potable water demand occurring simultaneously. Residential areas will be designed using a fire flow of 2,500 gpm with a residual pressure of 20 psi. Commercial areas were designed using a fire flow of 3,500 gpm and a residual pressure of 20 psi. All water demands will be based on the California Fire Code and approved by the City.

The projected potable water demands applied to Parcel A' (Hilltop and Hillside) are for residential water supply, and the potable water demands applied to Parcel B' are for commercial and light industrial areas.

The proposed water system design is shown on Figure 8. The Hilltop System consists of 8 inch and 12 inch diameter pipes connecting to the University Mound System at Innes Street, and also connecting to the Hunters Point System at Jerrold Street. A pressure reducing valve may be required on the Hunters Point System near Donahue Street.

The proposed Hillside water system improvements consist of two 12 inch diameter mains. This system will connect to the University Mound System at Griffith Street, and to the Hunters Point System at the intersection of Earl and Jerrold Streets.

The proposed water system improvements will consist of Ductile Iron Pipe (DIP), hydrants located at intervals of not more than 450 feet, valves and appurtenances, and thrust blocking. All construction will satisfy City requirements and will comply with section 902 of the California Fire Code (CFC).

f. Reclaimed Water System

The Non-Potable and Reclaimed Water Use Ordinance of October 19, 1994 (Ordinance No. 393-94, Part II, Chapter 10, San Francisco Municipal Code) designates Hunters Point Naval Shipyard as a mandatory reclaimed water use area. The Ordinance requires dual plumbing for all new or remodeled buildings over 40,000 square feet, and for all irrigated areas over 10,000 square feet.

On-site reclaimed water connections to residential, commercial, and mixed use lots, and the subsequent provision of irrigation systems are part of vertical construction and are not a requirement of this Infrastructure Plan. It is not anticipated that buildings in Phase 1 will meet the legislative requirement for dual plumbing.

A reclaimed water distribution system will be constructed as indicated on Figure 9. This system will consist of ductile iron pipe and comply with City standards. Since a reclaimed water supply does not currently exist, the initial installation of the lines will be dry. The lines may be charged with potable water on an interim basis. This connection may require positive backflow prevention.

4. Dry Utilities

Dry utilities will include electricity, natural gas, and telecommunications. All dry utilities will be underground, in a joint trench. Additional features of the joint trench will include emergency Police and Fire Department communication facilities, interconnection facilities for traffic signals, and power for street lights. The dry utilities are described below.

a. Joint Utility Trench

Current electricity service to the Shipyard is provided by PG&E using overhead 12 kV line that is connected to the Shipyard load using splices to the Navy distribution facilities. This entire system will be replaced with a looped system.

With the exception of a few locations, the existing PG&E natural gas system on the Shipyard has been abandoned in place. Unused parts of the existing system have been cut and capped by PG&E. Redevelopment of the Shipyard will require complete replacement of the gas distribution system on the Shipyard. Any required upgrades to the PG&E off-site systems will be performed by PG&E.

Additional sources of electricity may also include on-site generation using renewable resources. The feasibility of all options is the subject of a study currently being conducted by SFPUC.

Electrical and gas distribution facilities will be included in a joint trench. The location of the joint trench system is shown on Figure 11. In an effort to minimize service interruptions, all on-site dry utilities will be installed with redundant loops. All on-site construction of gas and electrical facilities will be placed underground.

Work necessary to provide the joint trench for dry utilities will be done by the developer and will lie in public streets and in the sidewalk area if possible. Work will consist of trench excavation and installation of conduit ducts for telephone, cable, fiber optic, electrical, natural gas, fire and police alarm, and MUNI. The joint trench will also include four 2" conduits for DPT. Additionally, utility vaults, splice boxes, street lights and bases, wire and transformer allowance, and backfill will be included. The utility owners and franchises (such as PG&E) will be responsible for installing facilities such as transformers and wires.

All necessary and properly authorized public utility improvements for which franchises are authorized by the City shall be designed and installed in the public right-of-way in accordance with governing codes, rules, and regulations, and permits approved by DPW. Joint trenches and utility corridors will be utilized where feasible. The location and design of joint trenches must be approved by DPW. All subsurface vaults serving one building shall be placed behind the property line. If a subsurface vault serves the distribution system, it may be placed in the public right-of-way as approved by DPW. Where possible, these vaults will be located on private property. Other facilities (e.g., traffic controllers) shall be located above ground for operational reasons.

b. Street Lights

Street lights of the type indicated shall be installed at the locations indicated on Figure 12. Secondary power for street lighting shall be installed in a separate trench in accordance with City Regulations. Sections 937 through 943 of the San Francisco Public Works Code contain specific requirements for street lighting, and are hereby incorporated by reference. Where necessary, for joint Muni and street light functions, appropriate street lights and bases will be installed to City standards.

c. Telecommunications

A telecommunications system does not currently exist at the Hunters Point Shipyard. Necessary telecommunications linkages and high capacity communication bandwidth requirements will vary from parcel to parcel depending on land use.

The telecommunications system will provide for voice, video, and data service to all parcels. The actual platform will be determined upon an agreement with the appropriate service providers. It is assumed that these services will be provided through one of several alternative wiring/fiber systems, which will access buildings via the joint trench. The joint trench will include 12-4" conduits, and these conduits will be capable of supporting any of the current platform services. The telecom provider has not yet been determined. The telecom provider will have access to the ducts and will be responsible for maintenance.

In addition to the joint trench, a telecommunications connection from Third Street to the project and an on-site control system will be provided. The exact location of this connection will be determined during 90% design process. Telecommunications conductors will be installed in the joint trench, and will be the responsibility of the telecommunications provider. Connections from the joint trench to individual buildings will be the responsibility of vertical developers.

d. Public Utility Easements

With the approval of appropriate City department, public utility easements may be allowed at locations outside of the right-of-way. In the event appropriate City departments authorize the placement of utilities outside the public right-of-way, such utilities will be installed in accordance with the standards of this infrastructure plan and applicable City codes and regulations, including provisions for maintenance access. Such areas may not be required to be dedicated as public right-of-ways or improved per public right-of-way standards, but may include paving, street furnishings, lighting, landscaping, and irrigation.

5. Existing Utilities

Existing utilities will be removed or abandoned as appropriate. Existing utilities will be removed where they are within 10 feet of the existing ground surface. Utilities that are below that depth will be abandoned and filled with grout where practical. Abandoned utilities will not affect the location or future maintenance of new utility systems. Abandonment of utilities in proposed future public right-of-way areas will require

approval of DPW or other City departments with jurisdiction over the area. Specific requirements are addressed in the discussions of the various utilities presented above.

The water system for Parcels A/B' will be separated from the rest of the Shipyard, with no interconnections between property still owned by the Navy. A 16 inch water line will be constructed in Innes Avenue and Galvez Avenue to provide water to Buildings 101 and 110. This water line will become part of a backbone loop in Galvez/Fisher/Spear/Crisp during subsequent phases of the development. Buildings 916 and 808 will continue to be served from an existing Navy owned water line in Crisp Avenue. This connection will be metered by the Navy in accordance with the Conveyance Agreement between the Agency and the Navy. The tenants in these buildings will purchase their water service from the Navy.

As described in a previous section of this document, during the initial stage of construction, connections will be made to existing storm drains that cross Navy property.

No other connections will be made to existing pipes crossing Navy property.

Connections to existing pipes at the current boundary of the project between the Parcels A/B' and the City are described in the wet utility sections presented above.

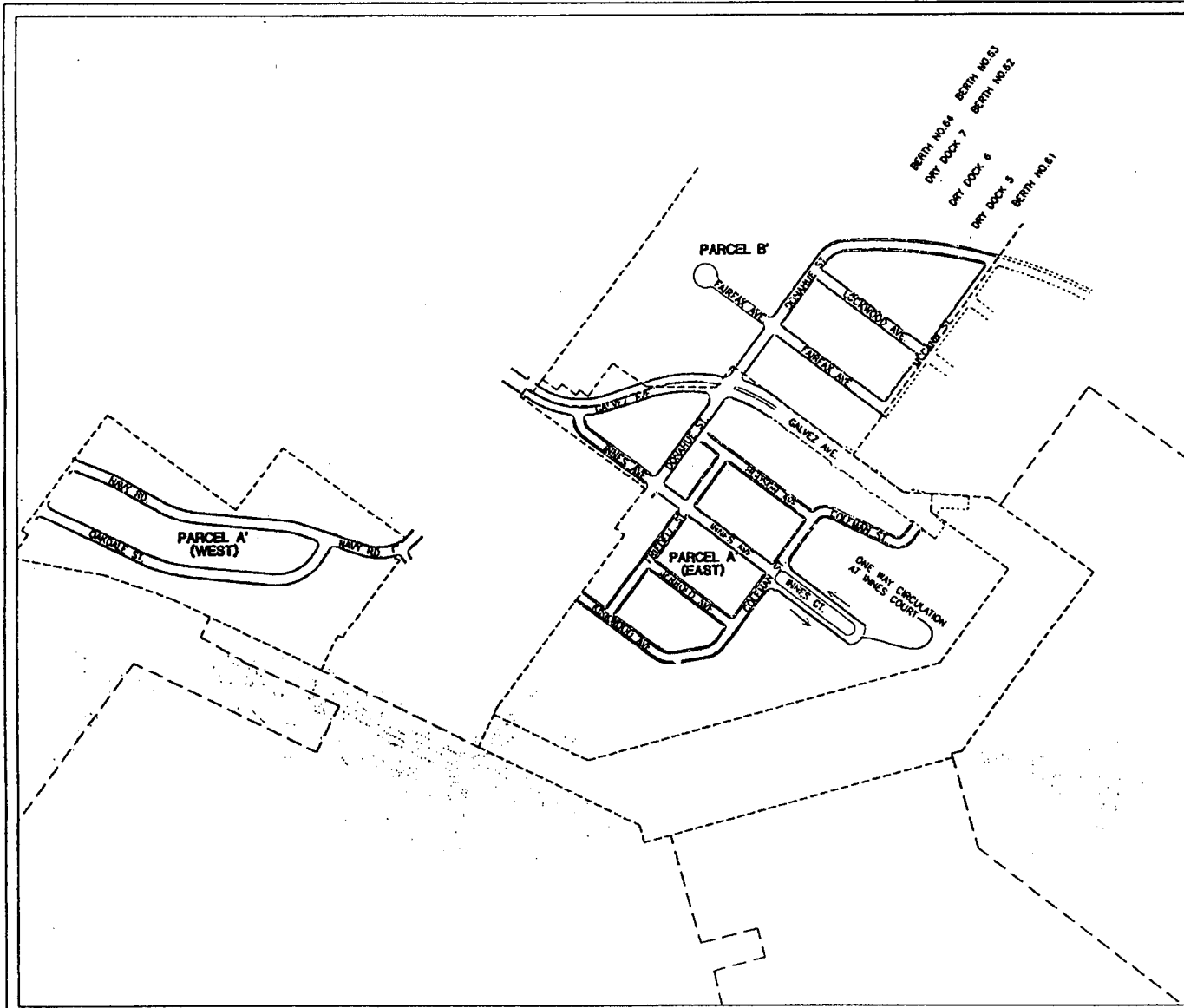

LEGEND

□ ALLEYS & MEWS

SCALE IN FEET

200' 0' 200' 400'

1" = 200'

FIGURE 3

STREET SYSTEM PARCEL A/B'

HUNTERS POINT SHIPYARD DEVELOPMENT PROJECT

PARCEL A' AND B' INFRASTRUCTURE

MARCH 5, 2003

LEGEND

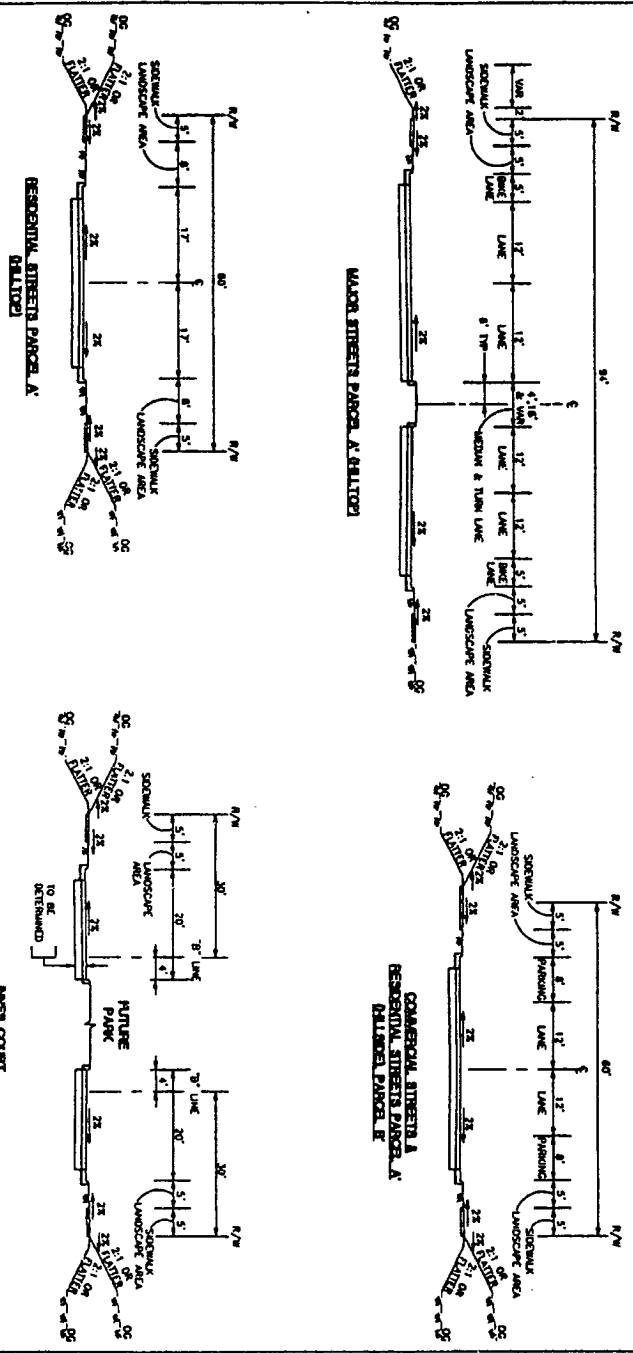

INSET COURT
SIA # 10-72 TO 18-43

NOT TO SCALE

FIGURE 4
TYPICAL STREET SECTIONS

HUNTERS POINT SHIPYARD DEVELOPMENT PROJECT
PARCEL A AND B INFRASTRUCTURE
MARCH 5, 2003

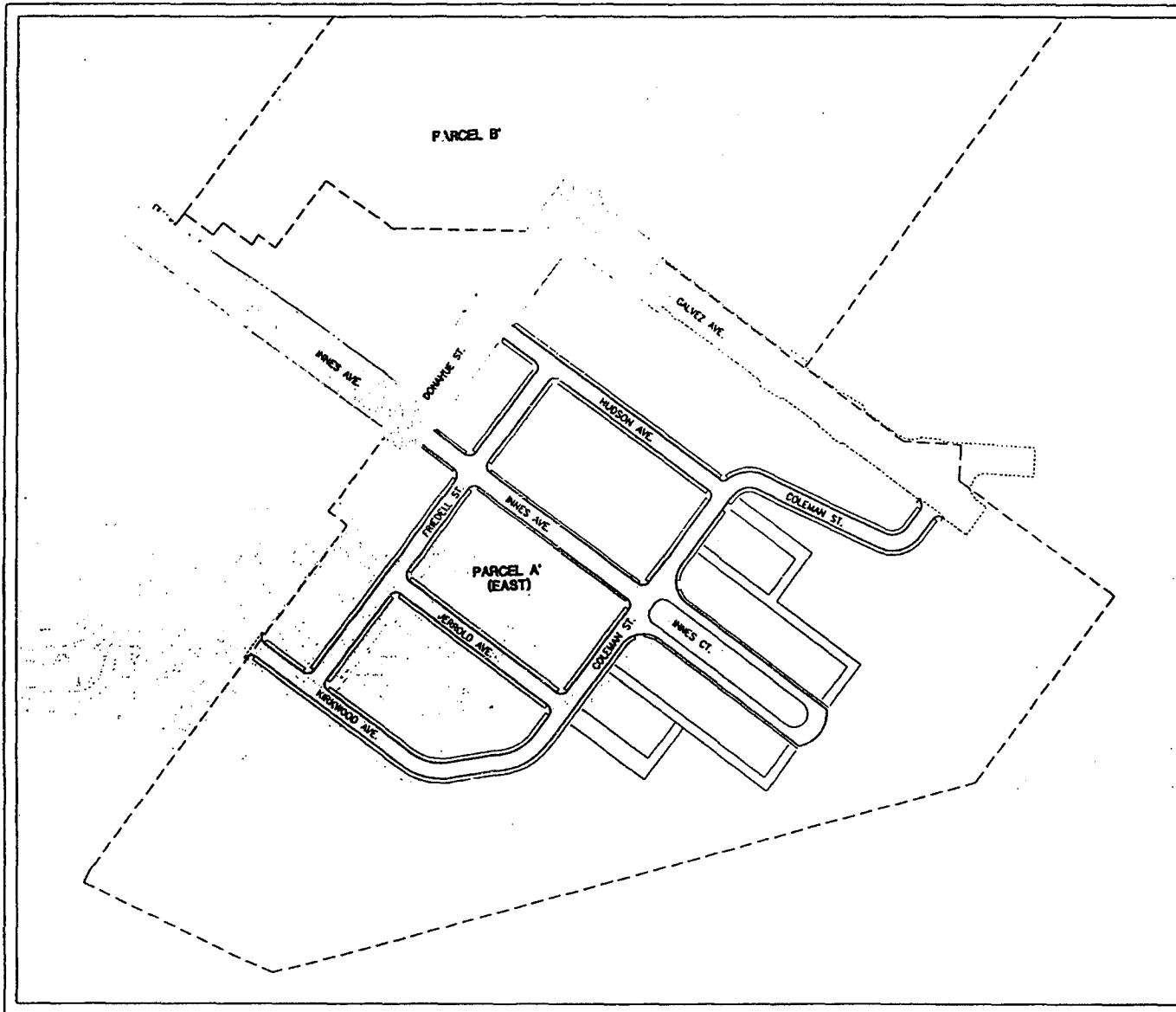

LEGEND

■ MODIFICATION LOCATIONS

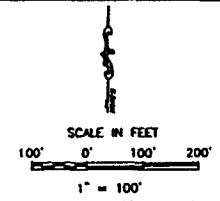
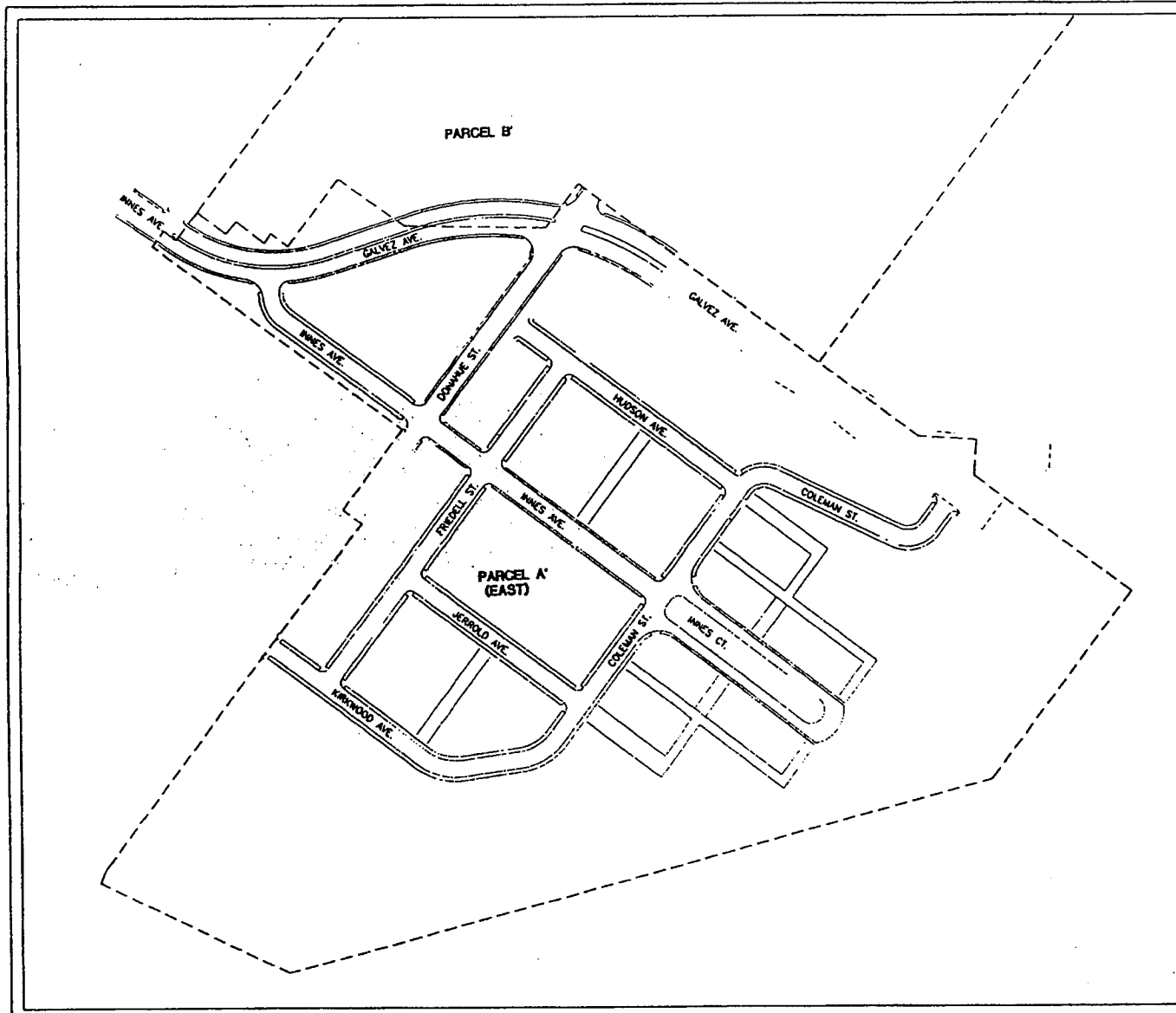

FIGURE 5
INNES/DONAHUE/GALVEZ
STAGE 1

HUNTERS POINT SHIPYARD DEVELOPMENT PROJECT
PARCEL A' AND B' INFRASTRUCTURE
MARCH 5, 2003



LEGEND

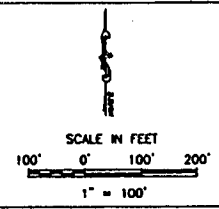
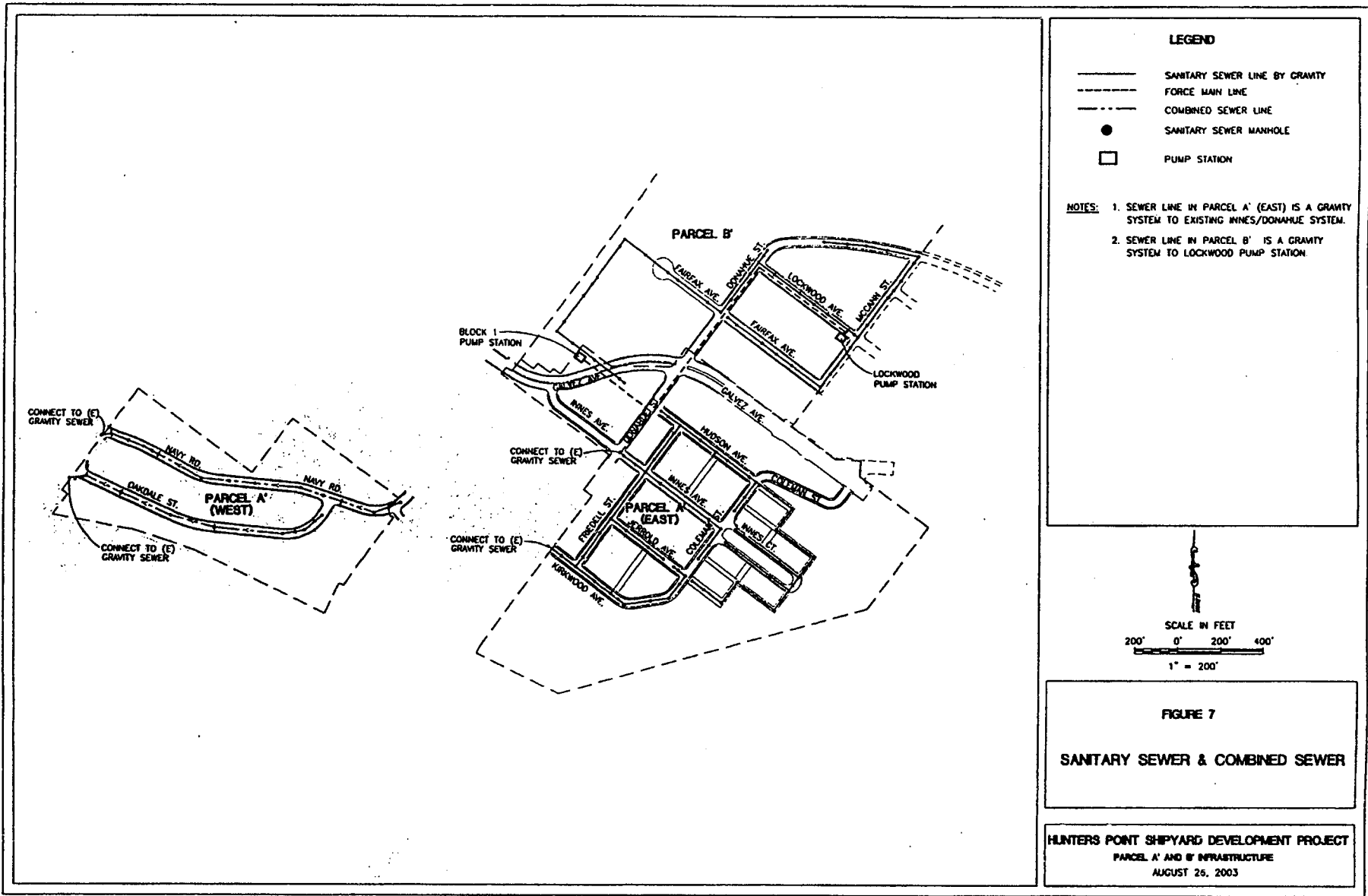
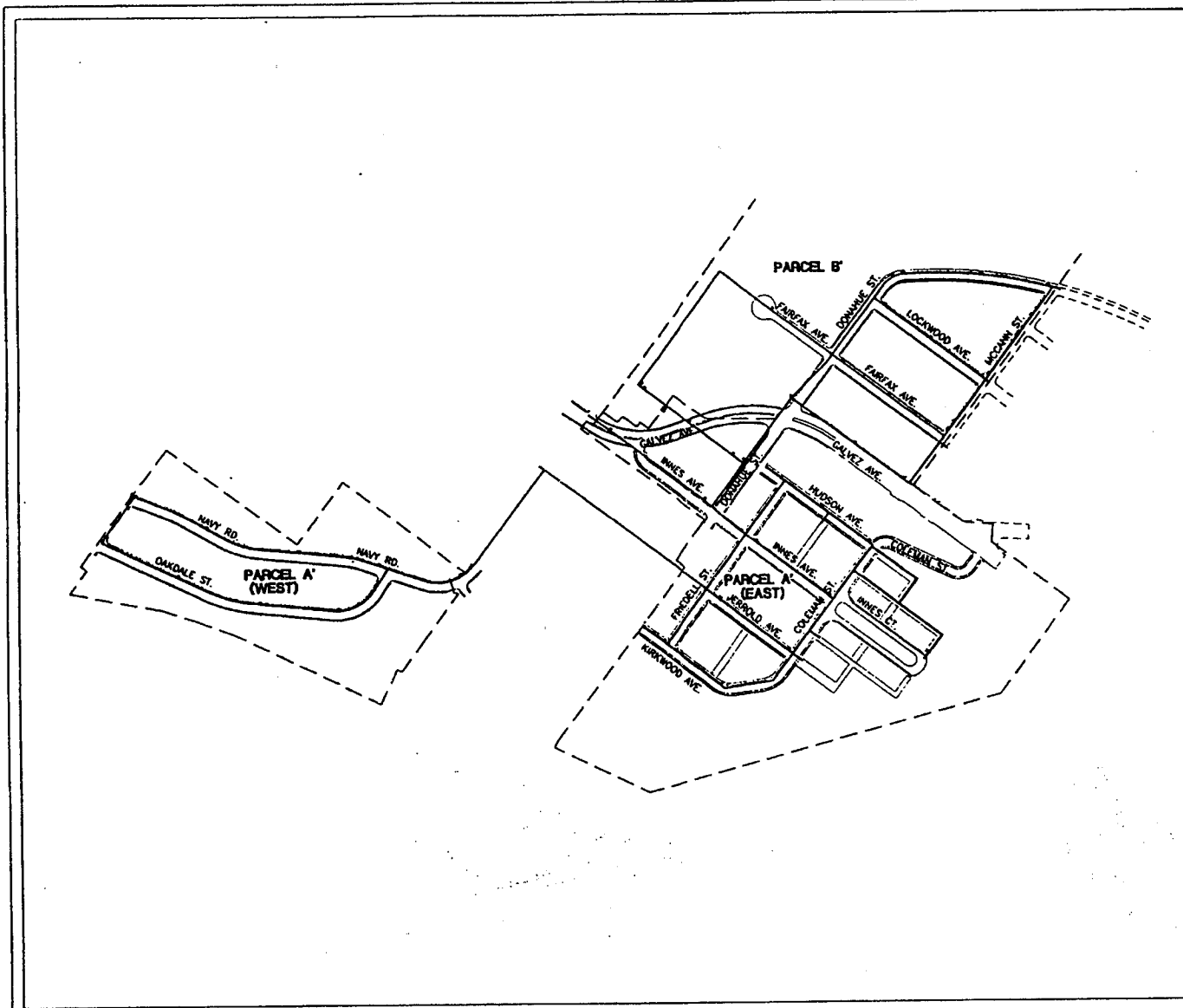

FIGURE 6
INNES/DONAHUE/GALVEZ
STAGE 2 "S" ALIGNMENT

HUNTERS POINT SHIPYARD DEVELOPMENT PROJECT
PARCEL A' AND B' INFRASTRUCTURE
MARCH 5, 2003





LEGEND

———— POTABLE WATER LINE

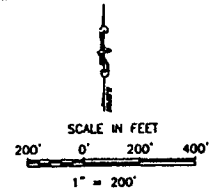
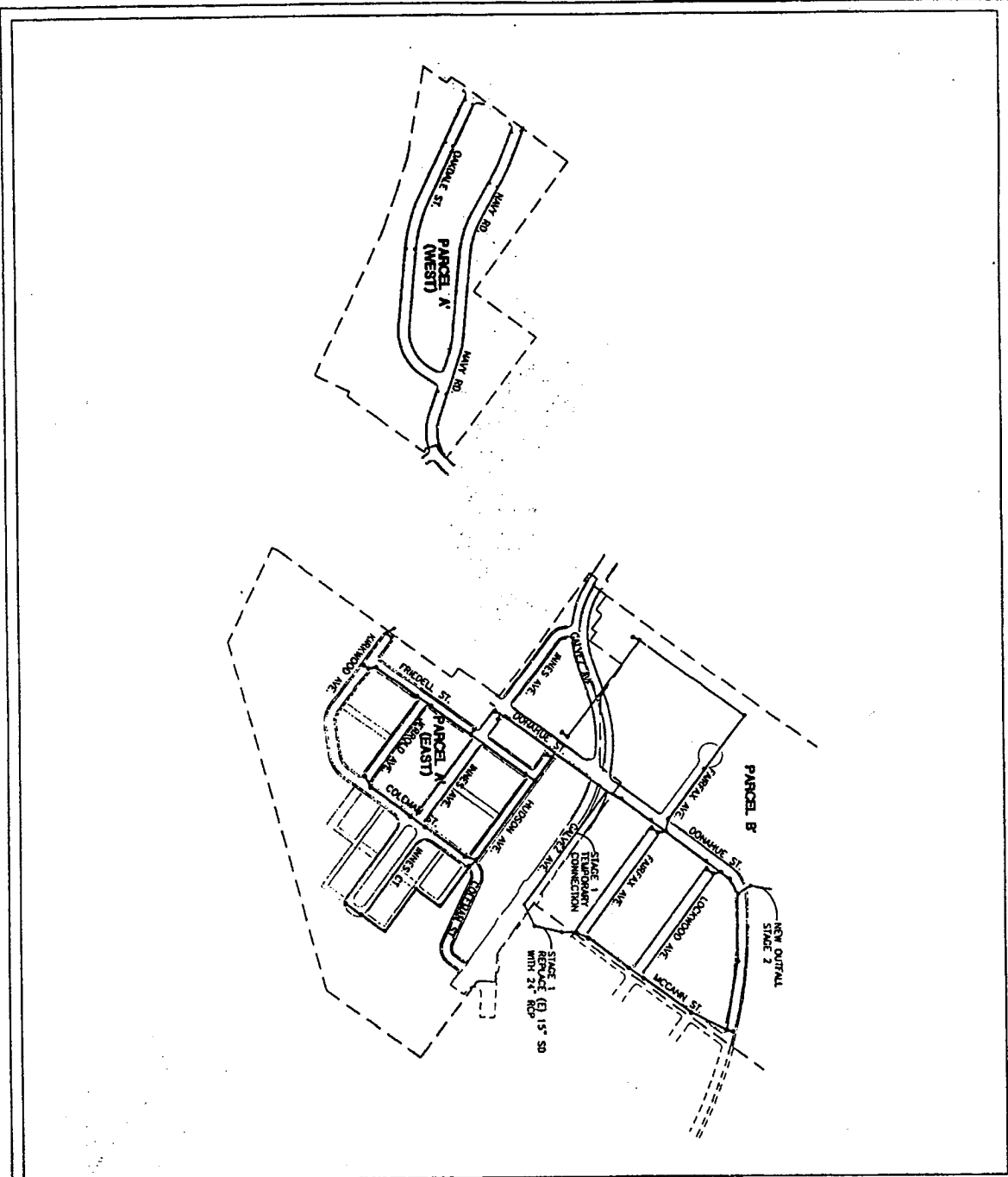

FIGURE 8
POTABLE WATER

HUNTERS POINT SHIPYARD DEVELOPMENT PROJECT
PARCEL A' AND B' INFRASTRUCTURE
MARCH 5, 2003



- LEGEND**
- STORM DRAIN LINE
 - DRAINAGE MANHOLE
 - DRAINAGE INLET

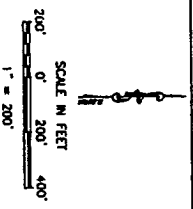
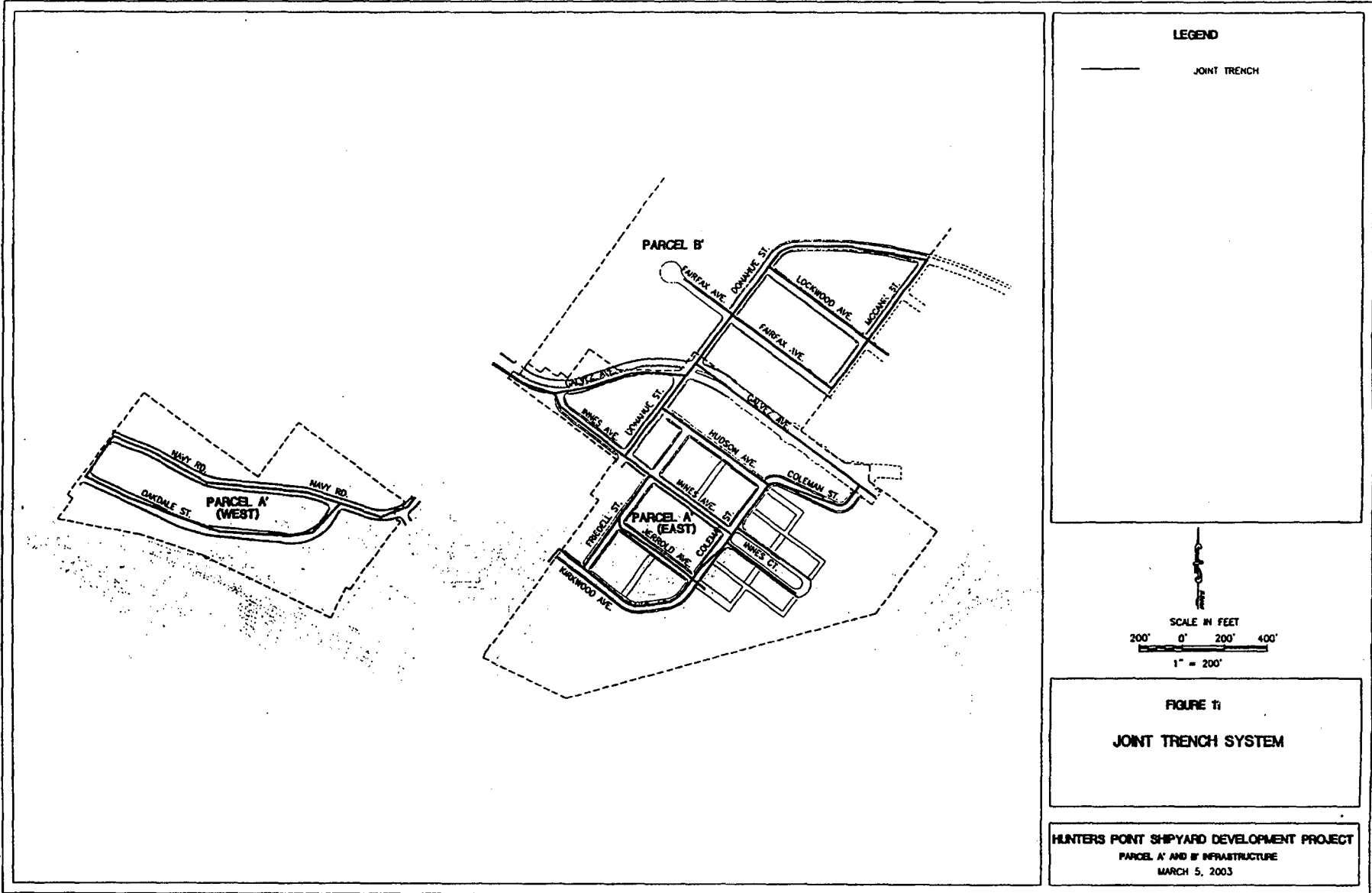

FIGURE 10
STORM DRAIN

HUNTERS POINT SHIPYARD DEVELOPMENT PROJECT
PARCEL A' AND B' INFRASTRUCTURE
 MARCH 5, 2003



LEGEND

———— JOINT TRENCH

SCALE IN FEET

200' 0' 200' 400'

1" = 200'

FIGURE 1:

JOINT TRENCH SYSTEM

HUNTERS POINT SHIPYARD DEVELOPMENT PROJECT

PARCEL A' AND B' INFRASTRUCTURE

MARCH 5, 2003

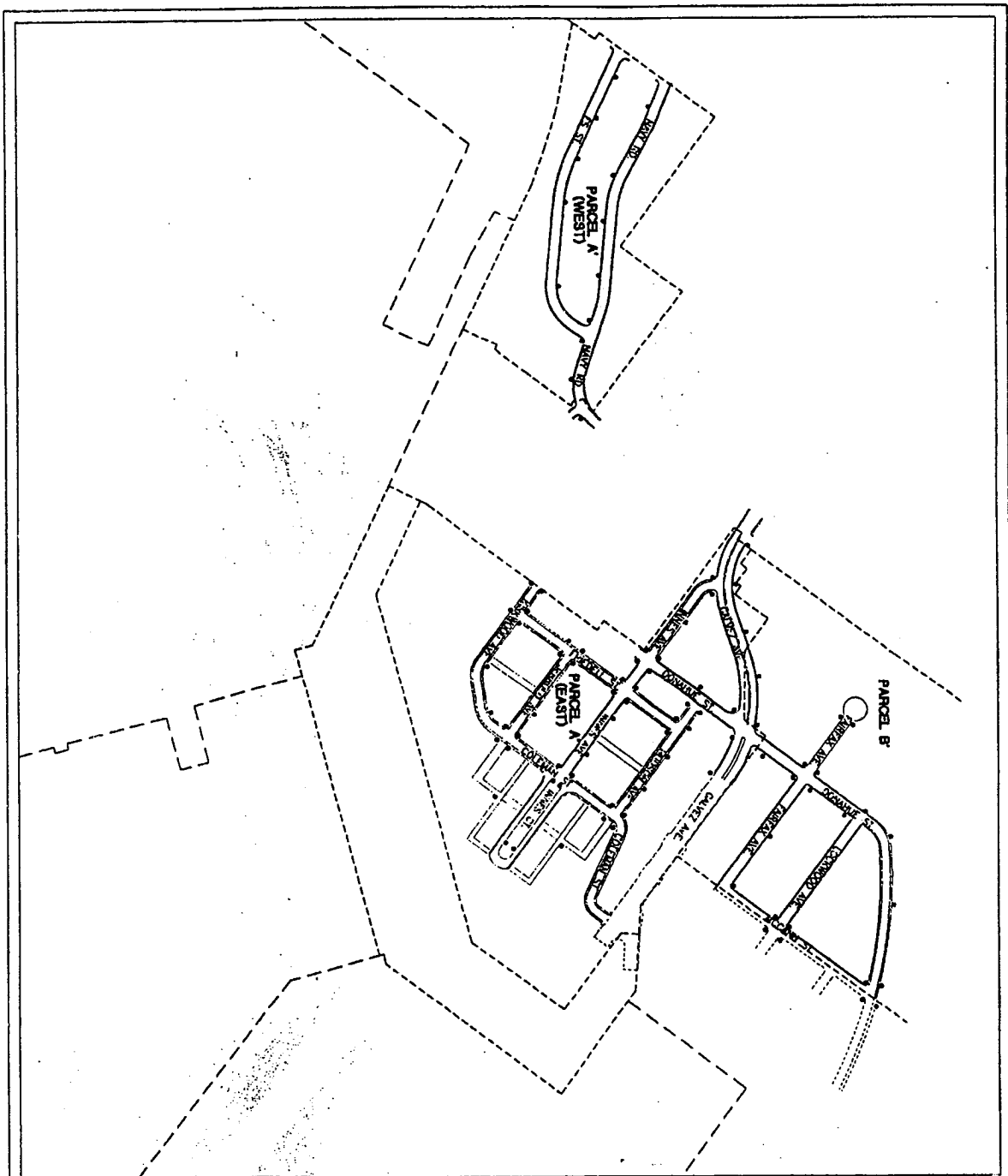

LEGEND

● LOCATION OF NEW STREET LIGHT

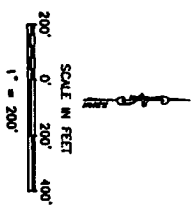

**FIGURE 2
STREET LIGHTS**

HUNTERS POINT SHIPYARD DEVELOPMENT PROJECT
 PARCEL A AND B RESTRUCTURE
 MARCH 5, 2003

EXHIBIT D - PUBLIC OPEN SPACE

1. Open Space Parcels

Parcel A' / B' will include a total of 28.6 acres of open space. The open space areas are indicated on Figure 13.

Stage 1 infrastructure development will include construction of three open space areas. These areas are shown on Figure 13. Two of these areas are the Hilltop Open Space (410,000 sf) and the Hillside Neighborhood Open Space (175,000 sf). These areas are intended to be natural open space areas, and will be hydro-seeded during Stage 1 to provide slope stabilization. The third area that will be included in the Stage 1 development is the Galvez Steps, an area of approximately 10,250 sf that runs from Hudson Street to Galvez Street. This area will be approximately 50% hardscape and 50% softscape, and will include steps, children's slide, seat walls and benches, and native, low maintenance, and drought tolerant plants.

During Stage 2, approximately 100,000 square feet of promenade hardscape will be developed along the waterfront.

The waterfront promenade will provide opportunities for special events, concessions, walking, and viewing. Design features will include open treeless vistas along the promenade, setback seating alcoves and gathering areas, shoreline with steps to the water for fishing, trees and planters, wind break elements, and promenade with decorative paving. This area will be approximately 80% hardscape and 20% softscape.

2. Landscaping

In addition to the open space areas described above, streetscape landscaping will be provided in planting areas adjacent to street and sidewalks. All proposed street cross sections include landscaping. These areas will be approximately 70% hardscape and 30% softscape. Significant features will include tree-lined streets, walkways with shrubs, and groundcovers. Irrigation will be provided for all streetscape areas. Street lighting is addressed in the preceding dry utilities section.

3. Street Furniture

Street furniture included in this phase will consist primarily of benches and seating along the waterfront promenade and wetland area.

LEGEND

OPEN SPACE AREAS



SCALE IN FEET
200' 0' 200' 400'
1" = 200'

FIGURE 13

OPEN SPACE AREAS

HUNTERS POINT SHIPYARD DEVELOPMENT PROJECT
PARCEL A AND B INFRASTRUCTURE
MARCH 5, 2003

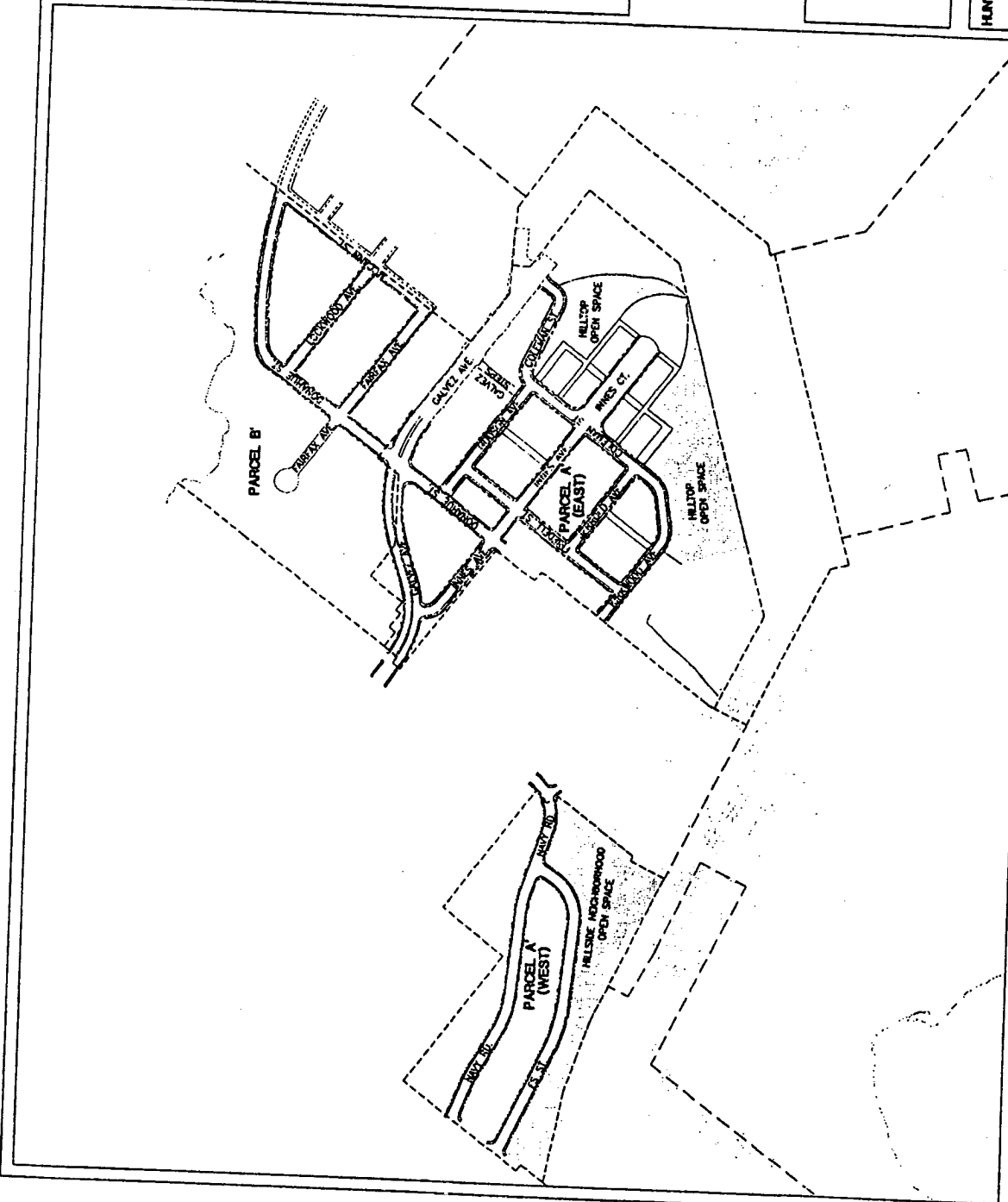

ATTACHMENT A
DEMOLITION / DECONSTRUCTION & REHABILITATION PLAN

Hunters Point Shipyard Building Inventory (from 1993 Navy Planning Document with SFRA Updates)
Notes on Page 6

HUNTERS POINT SHIPYARD BUILDING INVENTORY
BASED ON A 1993 NAVY INVENTORY with SFRA UPDATES

SERIAL #	Blg #	Parcel	Navy Description	Year Built/Type	Current Reuse	Area	Stories	Abatement Cost (1)	Demolition Cost (2)	Re-use Recommendation (3)	Cost Refurbish/Repair (4)	Cost Seismic/Structural Upgrade (5)	Cost ADA Upgrade (6)	Allowable Floor Load PSF (7)
1	14191	A	Acft by Dago Mary's	1644/wood				\$ 7,680.00	\$ 45,000.00	No HI				
2	14192	A	R65A	1810-1818/wood				\$ 5,000.00	\$ 25,000.00					
3	14193	A	A T R33 R36 R36A	1920-1928/wood				\$ 11,000.00	\$ 75,000.00					
4	14194	A	R39 R45 R76 R78	1920-1922/wood				\$ 21,000.00	\$ 81,000.00					
5	14195	A	R94 R97 R167	1920-1923/wood				\$ 15,000.00	\$ 64,200.00					
6	14196	A	R R14 R16 S U	1930-1938/wood				\$ 28,000.00	\$ 127,000.00					
7	14197	A	A19 E F G H I	1920-1933/wood				\$ 26,000.00	\$ 129,500.00					
8	14198	A	R25 R27 R28	1820-1838/wood				\$ 18,000.00	\$ 84,000.00					
9	14199	A	A2 C D E L M J O P	1840-1848/wood				\$ 48,700.00	\$ 188,200.00					
10	14200	A	V W X Y Z	1853/wood				\$ 47,000.00	\$ 110,000.00					
11	14201	A	O25 R100 R105 R108	wood				\$ 22,000.00	\$ 80,000.00					
12	14202	A	Substation in Bldg					\$ 1,000.00	\$ 25,000.00					
13	14203	A	Electric Substation	2000/Conc	Electric substa	11,150	2	\$ 10,800.00	\$ 10,000.00	No J	\$ 40,000.00	\$ 15,000.00	\$ 10,000.00	400 SLAB ON GRADE
14	14204	A	Admin Off Bldg	1940/wood	Admin	119,000	2	\$ 261,100.00	\$ 990,000.00	No E1	\$ 6,800,000.00	\$ 4,182,000.00	\$ 2,200,000.00	150 2ND FLOOR
15	14205	A	Admin Off Bldg	1940/wood	Admin	16,950	2	\$ 54,588.00	\$ 108,000.00	No E1H				
16	14206	B	Admin Off Bldg	1940/wood	Admin	14,184	2	\$ 23,400.00	\$ 75,000.00	No E1				
17	14207	B	Admin Off Bldg	1940/wood	Admin	14,184	2	\$ 20,400.00	\$ 72,000.00	No E1				
18	14208	B	Police Dept	1941	Police Dept		1	\$ 7,200.00	\$ 55,000.00	No E1H				
19	14209	A	Admin Off Bldg	1940/wood	Admin	20,600	2	\$ 35,700.00	\$ 78,000.00	No E1	\$ 1,842,000.00	\$ 820,000.00	\$ 248,024.00	100 2ND FLOOR
20	14210	B	Gen whse/Bulk	1940/wood		15,800	1	\$ 42,100.00	\$ 128,000.00	No I				
21	14211	B	Metalwork Lab	1940/wood	Smith-Emory	16,184	1	\$ 17,125.00	\$ 48,000.00	No I				
22	14212	B	Electronics Shop	1940/wood	Cabinetry	13,584	2	\$ 40,000.00	\$ 125,000.00	No I				
23	14213	B	Paint Shop	1940/wood	Standard/acc/Bldg	18,428	2	\$ 45,500.00	\$ 200,000.00	No I				
24	14214	B	Admin Off Bldg	1940/wood	Admin	14,184	2	\$ 20,700.00	\$ 78,000.00	No E1H				
25	14215	B	Public Toilet Bldg	1940/wood	Public	1,200	2	\$ 24,800.00	\$ 178,000.00	No E1H				
26	14216	B	Admin Off Bldg	1940/wood		25,000	2	\$ 31,000.00	\$ 150,000.00	No E1H				
27	14217	B	Misc util plant bldg	1944/wood		3,225	1	\$ 8,000.00	\$ 45,000.00	No GF				
28	14218	B	Garment/whse/Bldg	1940/wood		21,174	2	\$ 142,000.00	\$ 800,000.00	No E1H	\$ 5,500,000.00	\$ 2,250,000.00	\$ 828,144.00	400 SLAB ON GRADE
29	14219	B	Metalwork Lab	1940/wood	Cabinetry	10,116	1	\$ 22,100.00	\$ 100,000.00	No E1H				
30	14220	B	Gen whse/Bulk	1940/wood	SP Police	24,120	1	\$ 31,850.00	\$ 125,000.00	No E1H				
31	14221	B	Paint-related bldg	1940/wood		26,428	1	\$ 29,800.00	\$ 165,000.00	No E1H				
32	14222	B	Public Toilet Bldg	1940/wood		1,000	1	\$ 300.00	\$ 8,500.00	No E1H				

LONG TERM REUSE
SHORT TERM REUSE
TO BE DEMOLISHED

Hunters Point Shipyard Building Inventory (from 1993 Navy Planning Document with SFRA Updates)
Notes on Page 6

Serial #	File #	Parcel	Navy Description	Year Built/Type	Current Reuse	Area	Stories	Abatement Cost (1)	Demolition Cost (2)	Reuse Recommendation (3)	Cost Refurbish/Repair (4)	Cost Seismic/Structural Upgrade (5)	Cost ADA Upgrade (6)	Allowable Floor Load (PSF) (7)
23	174	C	Maine Mach Shop	1945/wood		31,778	2	\$ 57,700.00	\$ 650,000.00	No F	\$ 3,100,000.00	\$ 1,274,400.00	\$ 814,412.00	400 SLAB ON GRADE
24	177	B	Veh Rep/Fuel Shop	1942/wood		1,000	1	\$ 250.00	\$ 5,500.00	No EFG14				
25	180	B	Cryoback Pumphouse	1915/wood	Historical	4,628	1	\$ 30,375.00	\$ 100,000.00	Yes B	\$ 750,000.00	\$ 82,400.00	\$ 86,412.00	100 SLAB ON GRADE
26	141	B	Vandwouwing Shop	1942/wood		8,400	2	\$ 5,000.00	CONE	No EFG14				
27	144	D	Public Toilet Bldg	1945/stone		1,000	1	\$ 2,000.00	\$ 1,200.00	No EFG14				
28	146	H	Fire pump sta	1945/stone		8,200	1	\$ 23,200.00	\$ 150,000.00	No EFG14				
29	150	B	Weather Shelter	1944				\$ 400.00	\$ 5,500.00	No EFG14				
30	154	C	Main stc (sheds)	1943				\$ 3,800.00	\$ 12,000.00	No EFG14				
31	159	H	Rubber Shop	wood		1,000	1	\$ 7,600.00	\$ 8,500.00	No EFG14				
32	157	B	Gen whse/bulk	1853				\$ 3,500.00	\$ 25,000.00	No EFG14				
33	158	A	Gen Energy Hse	1855/stone	Gen Energy Hse			\$ 100.00	\$ 5,000.00	No F	\$ 10,000.00	\$ 2,500.00	\$ 10,000.00	400 SLAB ON GRADE
34	158	B	Public Toilet Bldg	1950				\$ 4,200.00	\$ 15,000.00					
35	223	C	concrete			17,171		\$ 187,003.00	\$ 155,000.00	No E11				
36	254	C	Fire pump sta	1901/stone		500	1	\$ 8,200.00	\$ 10,000.00	Yes B				
37	255	C	Drydock Pumphouse	1901/stone	Historical	12,871	1	\$ 42,100.00	\$ 250,000.00	Yes B	\$ 3,325,000.00	\$ 1,064,031.00	\$ 212,878.00	400 SLAB ON GRADE
38	258	G	Main stc (sheds)	1943/wood		2,000	1	\$ 4,800.00	\$ 30,000.00	No DEH	\$ 120,000.00	\$ 30,000.00	\$ 40,000.00	400 SLAB ON GRADE
39	267	C	Public Toilet Bldg	1942/stone		2,000	1	\$ 60,200.00	\$ 32,000.00	No DEH				
40	267	C	Shed/Work Shop	1942/wood		4,484	1	\$ 5,480.00	\$ 40,000.00	No DEH	\$ 250,000.00	\$ 188,000.00	\$ 89,780.00	400 SLAB ON GRADE
41	271	C	Gen whse/bulk	1942/wood		83,243	1	\$ 81,200.00	\$ 830,000.00	No DEH	\$ 3,410,000.00	\$ 1,873,000.00	\$ 373,000.00	400 SLAB ON GRADE
42	274	C	Admin Off Bldg	1942/wood		12,000	2	\$ 55,000.00	\$ 280,000.00	No DEH				
43	276	C	Fire Station	1942/wood	Fire station	17,808	2	\$ 40,900.00	\$ 170,000.00	No DEH	\$ 630,000.00	\$ 383,000.00	\$ 147,920.00	100 2ND FLOOR
44	277	C	Gen whse/bulk	1943/wood		44,120	1	\$ 34,500.00	\$ 250,000.00	No DEH				
45	278	C	Public Toilet Bldg	1943/stone		500	1	\$ 1,100.00	\$ 5,500.00	No DEH				
46	279	C	Substation	concrete	Substation	3,721	1	\$ 5,800.00	\$ 15,000.00	No				
47	274	C	Air Raid Shelter/Storage	stone		5,000		\$ 2,500.00		No				
48	275	C	Gen whse/bulk	1943/wood		3,000	1	\$ 17,800.00	\$ 40,000.00	No DEH				
49	276	C	Public Toilet Bldg	1943/stone		1,000	1	\$ 2,300.00	\$ 12,500.00	No DEH				
50	278	C	Central Canteen	1942/stone		45,000	2	\$ 44,040.00	\$ 415,000.00	No DEH				
51	278	C	Substation	concrete	Substation	630	1	\$ 800.00	\$ 10,000.00	No				
52	280	C	Auto vehicle shop	1943/stone	Signs Boards	6,920	1	\$ 12,500.00	\$ 38,000.00	No DEH				
53	281	C	Industrial Mach Shop	1951/stone		181,800	2	\$ 143,400.00	\$ 1,957,000.00	Yes K	\$ 8,748,000.00	\$ 1,830,000.00	\$ 2,282,000.00	100 2ND FLOOR
54	274	C	Admin Off Bldg	1943				\$ 3,600.00	\$ 25,000.00	No DEH				
55	274	C	DM4 Pump House	concrete	DM4 Pump Hse	450	1	\$ 500.00	\$ 10,000.00	No J	\$ 30,000.00	\$ 12,000.00	\$ 10,000.00	400 SLAB ON GRADE

LONG TERM REUSE
SHORT TERM REUSE
TO BE DEMOLISHED

Hunters Point Shipyard Building Inventory (from 1993 Navy Planning Document with SFRA Updates)
Notes on Page 6

SERIAL #	Bldg #	Parcel	Navy Description	Year Built	Type	Current Reuse	Area	Stories	Attainment Cost (1)	Demolition Cost (2)	Re-use Recommendation (3)	Cost Refurbish/Repair (4)	Cost Seismic/Structural Upgrade (5)	Cost ADA Upgrade (6)	Allowable Floor Load (PSF) (7)
61	241	C	Forge & Heat	1943	wood		25,000	1	\$ 24,000.00	\$ 110,500.00					
67	251	C	Gen whse/bldg	1947	wood		59,190	2	\$ 77,500.00	\$ 830,000.00	No EPH	\$ 2,100,000.00	\$ 1,404,000.00	\$ 613,500.00	50 2ND FLOOR
68	252	C	Sus Steeps	1944	wood		8,274	1	\$ 16,500.00	\$ 54,000.00	No				
69	253	CC	Elec Control Mtg Sh	1947	concr		195,247	5	\$ 357,889.00	\$ 1,930,000.00	Yes K	\$ 6,500,000.00	\$ 3,008,840.00	\$ 1,129,000.00	100 3RD FLOOR
70	258	C	Admin Off Bldg	1937	concr		77,000	3	\$ 98,200.00	\$ 600,000.00	Yes A	\$ 2,800,000.00	\$ 1,694,000.00	\$ 1,428,000.00	80 2ND FLOOR
71	270	C	Gen whse/bldg	1943				1	\$ 41,100.00	\$ 145,000.00	No DEM				
72	271	C	Gen whse/bldg	1947	wood		8,013	1	\$ 12,500.00	\$ 48,000.00	No DEM				
73	272	C	Rigging Shop	1947	metal	State Boards	38,644	1	\$ 23,300.00	\$ 204,000.00	No DEM				
74	273	C	Shower	1943				1	\$ 800.00	\$ 3,500.00	No H				
75	274	D	Gen whse/bldg	1930	AMC		4,000	1	\$ 8,500.00	\$ 25,000.00	No				
76	275	C	Foundry	1947	wood	State Boards	8,790	1	\$ 3,500.00	\$ 35,000.00	No DEM				
77	280	C	Sheet Metal Shop	1948			1,780	1	\$ 1,300.00	\$ 18,500.00	No DEM				
78	281	C	Gen whse/bldg	1973	Steel		45,000	1	\$ 9,800.00	\$ 630,000.00	Yes A	\$ 1,125,000.00	\$ 916,000.00	\$ 640,000.00	400 SLAB ON GRADE
79	282	C		400C			5,900	1	\$ 2,200.00	\$ 48,000.00	No				
80	287	C		wood			800	1	\$ 1,200.00	\$ 9,000.00	No				
81	288	C	Substation	concrete	AMC		1,482	1	\$ 2,700.00	\$ 18,000.00	No	\$ 50,000.00	\$ 12,000.00	\$ 10,000.00	400 SLAB ON GRADE
82	291	C		AMC			4,418	1	\$ 12,500.00	\$ 25,000.00	No EPH				
83	292	D	Auto vehicle shop	1945	RR Masonry		30,000	1	\$ 77,500.00	\$ 221,000.00	No I				
84	293	D	Auto vehicle shop	1944	wood	Quality Craft	4,000	1	\$ 14,318.00	\$ 38,000.00	No DEM				
85	294	D	Auto vehicle shop	1945	concr		800	1	\$ 1,200.00	\$ 18,000.00	No DEM				
86	295	D	Auto vehicle shop	1945	concr	AMC	1,000	1	\$ 7,800.00	\$ 17,000.00	No DEM				
87	297	D	Industrial Mach shop	1944	Welded Joints		10,000	1	\$ 12,800.00	\$ 60,000.00	No DI				
88	298	D	Pump House	concrete	AMC		1,482	1	\$ 2,700.00	\$ 18,000.00	No D				
89	299	D	Public Toilet Bldg	1944	concr	AMC	4,000	1	\$ 4,000.00	\$ 18,000.00	No DEM				
90	299	D	Admin Off Bldg	1946	wood	Artiste	8,000	1	\$ 1,500.00	\$ 28,000.00	No DEM				
91	294	D	Misc util pnt bldg	1946	wood		6,000	1	\$ 6,248.00	\$ 48,000.00	No DEM				
92	291	D	Electronics Shop	1945				4	\$ 34,400.00	\$ 675,000.00	No EPH				
93	282	D	Elec Control Mtg Sh	1935	concr		27,800	1	\$ 66,880.00	\$ 250,000.00	No EPH				
94	280	D	Missle Test Bldg						\$ 78,000.00		No ?				
95	293	D	Weaponry Shop	1945	wood	Quality Craft	4,200	2	\$ 41,700.00	\$ 210,000.00	No EPH				
96	284	D	Storage	concrete	Young Labor		22,590	1	\$ 9,800.00	\$ 145,000.00	No EPH				

.....	LONG TERM REUSE
.....	SHORT TERM REUSE
.....	NO BE DEMOLISHED

Hunters Point Shipyard Building Inventory (from 1993 Navy Planning Document with SFRA Updates)
Notes on Page 6

SERIAL #	Blg #	Parcel	Navy Description	Year Built	Type	Current Reuse	Area	Stories	Acquirement Cost (1)	Demolition Cost (2)	Reuse Recommendation (3)	Cost Rebuild/Repair (4)	Cost Seismic/Structural Upgrade (5)	Cost ADA Upgrade (6)	Allowable Floor Load or PSF (7)
81	381	D	Admin Off Bldg	1951	concr		600	1	\$ 12,513.00	\$ 8,300.00	No Eff				
82	388	D	Printing Plant	1952	wood	Chris Eng/En	35,313	1	\$ 22,428.00	\$ 185,000.00	No Eff				
83	389	C	Ship Supp Equip Cn			AMC	2,000		\$ 5,200.00	\$ 18,200.00	No Eff				
84	389	D	Carpenter Shop	1953		AMC	8,000	1	\$ 4,950.00	\$ 35,000.00	No Eff				
85	390	D	Shops			AMC	8,810	1	\$ 2,200.00	\$ 40,000.00	No Eff				
86	370	D	Public enter bldg	1953				1	\$ 5,500.00	\$ 10,000.00	No Eff				
87	371	F	Admin Off Bldg	1954	metal	Body shop	42,860	1	\$ 3,200.00	\$ 3,200.00	No Eff				
88	372	D	Photo darkroom shop			AMC	8,000	1	\$ 4,000.00	\$ 36,000.00	No Eff				
89	376	D	Guided missile lab	1957	concr		400	1	\$ 5,340.00	\$ 10,000.00	No Eff				
90	373	E	Entrance showr			concrete	Lane		\$ 3,500.00	\$ 15,000.00	No Eff				
91	378	D	Guided missile lab	1962	metal	Navy office	1,280	1	\$ 1,970.00	\$ 15,000.00	No Eff				
92	379	D	Guided missile lab	1962	metal	Navy shop	1,000	1	\$ 3,000.00	\$ 10,000.00	No Eff				
93	381	D	Ship-Mat equip Lab	1968	metal	Wharf James	4,480	2	\$ 4,000.00	\$ 20,000.00	No Eff				
94	383	D	Gen whse/buk	1965	metal	Navy shop	10,200	2	\$ 5,500.00	\$ 44,000.00	No Eff				
95	384	D	Misc Supp Eq Lab	1965		Misc equip shop		1	\$ 2,300.00	\$ 38,000.00	No Eff				
96	385	D	Misc Supp Eq Lab	1965	metal	Navy shop	3,872	1	\$ 1,900.00	\$ 20,000.00	No Eff				
97	400	E	Gen whse/buk	1943				1	\$ 55,000.00	\$ 215,000.00	No Eff				
98	401	D	Misc Lab Misc Bldg	1943	wood	Admin	42,004	1	\$ 78,800.00	\$ 153,000.00	No Eff				
99	402	E	Gen whse/buk	1943	concr		36,214	1	\$ 29,800.00	\$ 125,000.00	No Eff				
100	406	D	Steel Mill Shop	1943	wood	Steel metal	43,525	1	\$ 38,000.00	\$ 215,000.00	No Eff				
101	407	D	Handmade whse	1943	wood		42,183	1	\$ 48,000.00	\$ 215,000.00	No Eff				
102	408	E	Gen whse/buk	1943	wood	Administrative	42,183	1	\$ 48,700.00	\$ 215,000.00	No Eff				
103	409	D	Gen whse/buk	1943		Army Van Unit	42,183	1	\$ 73,000.00	\$ 255,000.00	No Eff				
104	409	D	Shedding Shop	1947	concr		1,024	1	\$ 49,200.00	\$ 15,000.00	No Eff				
105	408	D	Generator Hut						\$ 1,800.00	\$ 10,000.00	No Eff				
106	410	D	Drum Storage	1945			5,000		\$ 1,800.00	\$ 10,000.00	No Eff				
107	411	D	Shipping Shop	1945			257,978		\$ 377,000.00	\$ 1,250,000.00	No Eff	\$ 100,000,000	\$ 1,250,000,000	\$ 2,000,000,000	400 SLAB ON GRADE
108	412	D	Misc util pine bldg	1943			84	1	\$ 350.00	\$ 10,000.00	No Eff				
109	413	E	Gen whse/buk	1944	wood	Army Van Unit	30,598	1	\$ 37,000.00	\$ 175,000.00	No Eff				
110	414	E	Gen whse/buk	1944	wood		33,458	1	\$ 82,200.00	\$ 185,200.00	No Eff				
111	415	D	Gen whse/buk	1945			4,000	1	\$ 12,900.00	\$ 20,000.00	No Eff				

LONG TERM REUSE
SHORT TERM REUSE
TO BE DEMOLISHED

Hunters Point Shipyard Building Inventory (from 1993 Navy Planning Document with SFRA Updates)
Notes on Page 6

SERA #	Build #	Parcel	Navy Description	Year Built	Type	Current Reuse	Area	Stories	Abatement Cost (1)	Demolition Cost (2)	Re-use Recommendation (3)	Cost Refurbish/Repair (4)	Cost Seismic/Structural Upgrade (5)	Cost ADA Upgrade (6)	Allowable Floor Load (PSF) (7)
128	418	D	Gen wheelbldg	1948			4,020	1	12,300.00	\$ 20,000.00	No ?				
128	417	D	Gen wheelbldg	1947	conc	Hydro-Chem	500	1	750.00	\$ 13,000.00	No EPH				
130	419	D	Environmental lab	1947		Hydro-Chem	1,292	1	5,500.00	\$ 20,000.00	No EPH				
132	416	D	Misc util pnt bldg	1947	conc		582	1	2,800.00	\$ 10,000.00	No EPH				
132	419	D	Misc util pnt bldg	1947			1,320	1	24,200.00	\$ 9,000.00	No EPH				
132	421	D	Misc util pnt bldg	1947			100	1	250.00	\$ 10,000.00	No EPH				
132	420	D	Gen wheelbldg	1947		Hydro-Chem	805	1	3,200.00	\$ 10,000.00	No EPH				
132	418	D	Brick Gen Bldg	1948		Asph	5,000	1	15,000.00	\$ 25,000.00	No EPH				
132	422	D	Gen shop bldg	1948		West Edge Des	8,000	1	18,200.00	\$ 31,500.00	No EPH				
132	437	D	PW shop bldg	1954			700	1	1,200.00	\$ 8,500.00	No EPH				
132	438	D	Shoefly Shop	1950			500	1	800.00	\$ 10,000.00	No EPH				
132	439	D	General Warehouse	1973	metal		100,000	1	15,000.00	\$ 250,000.00	Yes A	\$ 7,300,000.00	\$ 2,000,000.00	\$ 1,200,000.00	400 SLAB ON GRADE
140	506	D	Enford Drs	1971			15,000	2	85,400.00	\$ 324,000.00	No EPH				
141	508	D	Retail	1942			20,000	2	98,100.00	\$ 535,000.00	No EPH				
142	521	E	Heat Plant Bldg	1948				1	184,879.00	\$ 85,000.00	No EPH				
143	523	D	Fire pump sta	1948			558	1	1,120.00	\$ 13,000.00	No EPH				
144	525	D	Gen wheelbldg	1948			5,000	1	3,800.00	\$ 20,000.00	No EPH				
144	526	J	Gen wheelbldg	1948			5,300	1	1,620.00	\$ 20,000.00	No EPH				
148	527	J	Elec par pnt bldg	1947	conc	substation	408	1	1,500.00	\$ 10,000.00	No J				
147	530	J	Auto Hobby Shop				1,000	1	3,800.00	\$ 50,000.00	No EPH				
148	609	E	Enslaved Drs	1971	conc		90,200	10	148,000.00	\$ 950,000.00	No D				
148	608	D	Police Training Facility	1977	metal	Officer's Lab	89,900	1	142,000.00	\$ 950,000.00	Yes A	\$ 840,000.00	\$ 1,200,000.00	\$ 600,000.00	400 SLAB ON GRADE
150	701	E	Equip holding shed	1945	wood	Magazine Control	8,015	1	3,800.00	\$ 45,000.00	No DEFH				
151	707	E	Animal hosp	1950	wood		9,000	1	13,800.00	\$ 26,000.00	No DEFH				
152	708	E	Gen wheelbldg	1948	conc		1,000	1	1,200.00	\$ 15,000.00	No DEFH				
153	709	E	Retail	1942	conc		1,000	1	1,200.00	\$ 35,000.00	No DEFH				
154	801	E	Gen wheelbldg	1953	metal	warehouse	37,000	1	89,000.00	\$ 275,000.00	No E	\$ 1,200,000.00	\$ 93,700.00	\$ 444,000.00	400 SLAB ON GRADE
154	802	D	Gen wheelbldg	1943		RR Museum	25,254	1	100,500.00	\$ 480,000.00	No I	\$ 1,980,000.00	\$ 1,118,480.00	\$ 871,000.00	400 SLAB ON GRADE
156	810	E	Haz Plan Bldg	1954			20,350	1	48,800.00	\$ 125,000.00	No DH				

LONG TERM REUSE
SHORT TERM REUSE
TO BE DEMOLISHED

Hunters Point Shipyard Building Inventory (from 1993 Navy Planning Document with SFRA Updates)
Notes on Page 6

SERIAL #	Blgd #	Part	Navy Description	Year Bldg Type	Current Reuse	Area	Stories	Attachment Cost (1)	Remediation Cost (2)	Reuse Recommendation (3)	Cost Refurb/Restore (4)	Cost Seismic/Structural Upgrade (5)	Cost ADA Upgrade (6)	Allowable Floor Load in PSF (7)
154	218	A	WH - HV ACCLB	1958		278,918	4	\$ 300,025.00	\$ 2,900,000.00	Yes A	\$ 8,500,000.00	\$ 2,216,000.00	\$ 3,312,000.00	300 2ND FLOOR
154	218	A	WH - HV ACCLB	1958				\$ 4,520.00	\$ 150,000.00	No DF1				
154	218	A	WH - HV ACCLB	1958		204	1	\$ 1,300.00	\$ 10,000.00	No DF1				
160	219	A	Storage pump #2	1957	Storage Pump	1,285	1	\$ 8,896.00	\$ 15,000.00	No J	\$ 15,000.00	\$ 12,000.00	\$ 10,000.00	400 SLAB ON GRADE
161	221	A	Substation	1978	Substation	600	1	\$ 1,700.00	\$ 10,000.00	No J	\$ 10,000.00	\$ 6,000.00	\$ 10,000.00	400 SLAB ON GRADE
162	223	A	Sticky gen bldg	1978	Storage Pump	600	1	\$ 500.00	\$ 10,000.00	No J	\$ 10,000.00	\$ 8,000.00	\$ 10,000.00	400 SLAB ON GRADE
163	223	A	Officers Club	1943	wood	6,304	2	\$ 28,800.00	\$ 275,000.00	No EH				
164	227	A	Garage	1944				\$ 1,280.00	\$ 10,000.00	No EH				
164	228	A	Garage	1944				\$ 2,200.00	\$ 10,000.00	No EH				
168	229	A	Garage	1944				\$ 1,000.00	\$ 10,000.00	No EH				
187	215	A	Admin Off Bldg	1940	wood	1,790	1	\$ 2,800.00	\$ 18,000.00	No EH	\$ 200,000.00	\$ 150,120.00	\$ 80,000.00	400 SLAB ON GRADE
190	219	A	Diago Mary's	1932	wood	12,000	1	\$ 6,100.00	\$ 60,000.00	No EH				
189	221	A	BOG	1989	stone	921	5	\$ 119,850.00	\$ 250,000.00	No EH				
190	221	A	Port Canal St	1983	steel									

LONG TERM REUSE
SHORT TERM REUSE
TO BE DEMOLISHED

1 Includes asbestos, lead, PCB's, fluorescent tubes.

2 Includes: Freon gas, hydraulic fluids.

3 Best judgment based on the following:

- A) Suitable construction.
- B) Historical value.
- C) Minimum decay.
- D) Poor Location.
- E) Poor construction.
- F) Inadequate usable space.
- G) Extensive decay.
- H) Cost to rehabilitate/repair exceeds costs to build new.
- I) Should be placed below grade.
- J) Architectural value.

4 Includes: Architectural/structural design drawings.

- A) Demolition of elements to be replaced.
- B) Replacement of all part of interior elements.
- C) Replacement of exterior elements.
- D) Replacement of exterior elements (stair, light, rain water leader, etc).
- E) Replacement of roofing membrane.
- F) Replacement of broken/damaged structural elements.
- G) Replacing railing.
- H) Take 24 energy conservation upgrade.
- I) Replace mechanical, electrical, plumbing system.

5 Includes: Structural calculations/structural design drawings.

- A) Roof diaphragm reinforcement.
- B) Shearwall installation.
- C) Shearwall reinforcement.
- D) Tie downs.
- E) Collectors/ties.
- F) Foundation modification.
- G) Foundation construction.

6 Includes: Architectural/structural design drawings.

- A) Building access ramps and railings.
- B) Toilet room access and accommodations.
- C) Signs.
- D) Easy open door hardware.
- E) Parking and signage for handicapped.
- F) Elevators.

7 Assumes structural elements are not broken or decayed (piece by piece inspection not included in this report).

DRAFT FINAL

**ATTACHMENT B
PROPOSED DESIGN STANDARDS**

DRAFT FINAL
Hunters Point Infrastructure Plan |
September 15, 2003

**DRAFT Design Criteria and Standards
Street Lights and Lighting System
Hunters Point Shipyard**

Foreword

The standards provided herein are intended to serve as a guide in the preparation of design plans and specifications for the street lights and lighting system at Hunters Point Shipyard (HPS), to suggest limiting values for items upon which an evaluation of such plans and specifications may be made by the reviewing authority, and to establish, as far as practicable, uniformity of practice and standards for street lights on public streets in the City and County of San Francisco (The City). The recommendations and preferences set forth in this document are used only to indicate desirable procedures or methods and serve as guidelines for designers. This document is not intended or designed as, nor does it establish, a legal standard for lighting. The Street Lighting Standards may be updated periodically. It is the ultimate responsibility of the designer to develop a system that provides for:

- Personnel and public safety,
- Flexibility for the addition of future lighting systems and loads,
- Ease of maintenance,
- Interchangeability of equipment,
- Aesthetics, and
- Cost.

PART 1 - GENERAL

- 1.1 Street light spacing shall be staggered and located at property lines when possible. Street light designs utilizing one, median or opposite configurations shall require approval of Bureau of Light, Heat and Power (BLHP) by variance.
- 1.2 All street lighting projects are subject to review, approval and inspection by BLHP. Design shall conform to these requirements except as otherwise approved by BLHP by variance. Permit and inspection fees are to be paid by the Developer with the submittal of plans. Additional fees shall be paid prior to reinspection.
- 1.3 BLHP shall designate specific connection points for connecting new street lights into the existing multiple street lighting system. BLHP shall only authorize energization after BLHP acceptance of the installation.
- 1.4 The following additional requirements apply to street lighting systems installed by private developers:
 - A. The Developer or its authorized representative shall make arrangements with the serving utility for service points. Service points shall be shown on the improvement plans. The Developer shall be responsible for all costs associated with connecting the streetlights which shall be paid directly to the

**DRAFT Design Criteria and Standards
Street Lights and Lighting System
Hunters Point Shipyard**

serving utility. The Developer shall verify the street light service point location(s) with the serving utility and have plans with the utility approved service points prior to installation. The Developer shall coordinate with BLHP on requesting energization from the serving utility.

- B. The Developer shall install concrete foundations, galvanized steel poles, bracket arms of the appropriate lengths, wiring and luminaries in accordance with the Street Light Standard Plans. Shop drawings and catalog cuts of all materials proposed shall be submitted for BLHP approval.
- C. The Developer shall not backfill trenches, place concrete, or cover substructures on rough electrical work without prior approval from BLHP.
- D. Prior to the completion of any street lighting work, the Developer shall notify BLHP for final inspection. BLHP's acceptance of newly installed street lights for maintenance will be based on the results of the final inspection. The Developer shall submit a complete set of as-built drawings to BLHP prior to scheduling a final inspection for approval and acceptance of the work. After a set of as-built drawings are submitted and determined to be complete by BLHP, the Developer may request for an inspection at least 2 business days before the intended inspection date.
- E. All street lighting systems utilizing street light lamps up to, and including, 150 watts shall be designed for 120-volt service unless connecting to an existing system. In the later case, the design shall conform to the system being connected to and must be specifically approved by BLHP by variance. Street lighting systems utilizing street light lamps above 150 watts shall require 240-volt service.

PART 2 - ROADWAY ILLUMINATION REQUIREMENTS

2.1 Design Conformity

The design of all street lighting systems shall conform to the average maintained foot-candle and uniformity ratio requirements of these specifications.

2.2 Area Classifications

Area classifications shall be based on the latest edition of the American National Standard Practice for Roadway Lighting [Illuminating Engineering Society (IES RP-8)].

2.3 Average Maintained Foot-Candle Requirements

**DRAFT Design Criteria and Standards
Street Lights and Lighting System
Hunters Point Shipyard**

Average maintained foot-candle requirement shall be based on the latest edition of the American National Standard Practice for Roadway Lighting (IES RP-8). For calculation, use a Light Loss Factor equal to 0.584.

PART 3 - STREET LIGHTS

3.1 Cobra Style Street Lights

A. Luminaires 70 watts through 150 watts shall be General Electric 250R2 or American Electric Series 113 and luminaires 200 watts and larger shall be General Electric M400R2 or American Electric Series 125 with appropriate wattage and IES distribution. Each luminaire shall be 120/240-volt high power factor magnetic regulator ballast, reflector, glass refractor and photoelectric control receptacle. All luminaires shall be carefully mounted in accordance with the manufacturer's instructions and recommendations. The lamps for the luminaires shall be clear high-pressure sodium vapor with mogul bases manufactured by General Electric, Philips, Sylvania or approved equal.

B. Steel street light standards shall be hot-dip galvanized steel poles (11 gauge, 8.0" x 4.01" x 28'-6") with 6-foot elliptical upswept hot-dip galvanized steel bracket arm assemblies as shown on PLAN A-27,029.2, Change 4, contained in the City's February 1, 2002 revision of the Standard Plans, prepared by DPW (City Standard Plans).

Concrete street light standards shall require approval of BLHP by variance. Concrete street light standards shall be 28 feet, marbelite round concrete standard with 6-foot elliptical upswept, hot-dip galvanized steel bracket arm assembly to provide a nominal mounting height of 30 feet from luminaire to roadway surface, and shall be furnished and installed on new concrete foundation, all as shown on PLAN A-32,051, Change 4.

C. Steel street light standards shall be Ameron Series Catalog No. PL 286, Union Metal Catalog No. 5809-B, Vermont Catalog No. DS36800A286 or approved equal. Concrete street light standards shall be Ameron Series Catalog No. 1C3-28, Union Metal Catalog No. 5438 or approved equal.

D. Street light pole heights shall conform to the applicable standard plans.

E. Street light bracket arm lengths shall conform to the applicable standard plans. Alternate bracket arm lengths shall require specific approval of BLHP by variance.

**DRAFT Design Criteria and Standards
Street Lights and Lighting System
Hunters Point Shipyard**

- F. The concrete footing requirements shall conform to the requirements of PLAN A-27,029.2, Change 4, for steel street light standards and PLAN A-32,051, Change 4, for concrete street light standards. The concrete used for foundations shall be Class 7-4000-1½ with 4-inches maximum slump in accordance with Section 800.11, Classes of Concrete, of the City's November 2000 revision of the Standard Specifications, prepared by DPW (City Standard Specifications). Class 7-400-1½ concrete requires a minimum of 7 sacks of Portland cement per cubic yard, a minimum compressive strength of 4,000 pounds per square inch (psi) in 28 days, using a maximum size of 1½-inches of coarse aggregate, and a slump of 4-inches.
- G. The base leveling requirements shall conform to the requirements of PLAN A-27,029.2, Change 4, for steel street light standards and PLAN A-32,051, Change 4, for concrete street light standards.
- H. The wiring for the street light shall conform to the requirements of PLAN 49,092.
- I. Cut-off lenses and devices shall require specific approval of BLHP by variance.

PART 4 - WIRING

- 4.1 All wiring methods and equipment construction shall conform to the National Electric Code (NEC) and applicable sections of the Standard Specifications, Bureau of Engineering, Department of Public Works, City and County of San Francisco dated July 1986.
- 4.2 All splices shall be made in accordance with PLAN 43,665, Change 2.
- 4.3 Unless authorized otherwise, all wiring for street lights No. 10 American Wire Gauge (AWG) shall be solid copper and No. 8 AWG or larger shall be stranded copper, insulated for 600 volts with a thermoplastic vinyl type (Type THW) insulation.

Wiring shall be of the following sizes:

- A. All field wiring: #8 minimum (NEC)
- B. Pull box to street light: #10 minimum (NEC)
- C. All wire in pole: #10 minimum (NEC)

**DRAFT Design Criteria and Standards
Street Lights and Lighting System
Hunters Point Shipyard**

PART 5 - PHOTOCELLS

- 5.1 For street lights equipped with photoelectric control, the photocell shall be Type IV consisting of a photoelectric unit which plugs into an Edison Electric Institute - National Electrical Manufacturer's Association (EEI-NEMA) twist-lock receptacle integral with the luminaire. The photoelectric controls shall be operable within a minimum voltage range between 105 and 305 volts. All photoelectric controls shall be oriented to the north. Photoelectric controls for luminaires shall be Dark To Light Model #D124-1.5-SM or approved equal having an instantaneous turn on at 1.5 ± 0.3 foot-candles and having a turn off/on ratio of 1½:1.

PART 6 - CONDUIT

- 6.1 Conduit shall be 1½-inch, hot-dip galvanized rigid steel as indicated in Section 601 of the City Standard Specifications.
- 6.2 All steel conduit and other metal parts, including bonding bushing, shall be hot-dip galvanized and shall be listed for the use. The conduit shall be continuously bonded and grounded in accordance with NEC requirements. All threads shall either have factory installed hot dip galvanizing or an listed thread protection compound.
- 6.3 All bends and offsets shall be made with listed conduit benders or using listed factory-made bends. The total of bends in one run of conduit shall not exceed 360 degrees.
- 6.4 All empty conduits shall have a one-quarter inch polypropylene pull rope provided inside and sealed with a duct seal, approved by BLHP, on both ends of the conduit.
- 6.5 The ends of all conduits installed shall be sealed with a duct seal approved by BLHP. Conduits stubbed for future extension shall be capped.

PART 7 - PULL BOXES

- 7.1 All pull boxes shall be per PLAN 49,093, Change 1, and shall be installed within five feet of the base of all street light poles.
- 7.2 All pull boxes shall be installed per PLAN 49,093, Change 1.
- 7.3 Pull boxes shall not be more than 250 feet apart on long runs.
- 7.4 Pull boxes shall not be placed where they will be subject to vehicular traffic.

**DRAFT Design Criteria and Standards
Street Lights and Lighting System
Hunters Point Shipyard**

- 7.5 All pull box covers shall be inscribed with first line, "STREET LIGHTING", and the second line, "120/240 VOLT". Letters shall be 1-inch and made with 1/4-inch wide strokes. Letters inscribed in concrete lids covers shall be made with 1/8-inch (minimum) deep imprints. Legends in steel covers shall be made with weld bead letters.

— End of Section —

**DRAFT Design Criteria and Standards
Low Pressure Domestic Water System
Hunters Point Shipyard**

Foreword

The standards provided herein are intended to serve as a guide in the preparation of design plans and specifications for the low pressure water supply system at Hunters Point Shipyard (HPS), to suggest limiting values for items upon which an evaluation of such plans and specifications may be made by the reviewing authority, and to establish, as far as practicable, uniformity of practice. The recommendations and preferences set forth in this document are used only to indicate procedures or methods and serve as guidelines for designers. It is the ultimate responsibility of the designer to develop a system that provides for:

- An adequate quantity of water to be available throughout the system at a pressure that meets the requirements of the San Francisco Fire Department (SFFD),
- Water that is to be delivered to consumers meets the current water quality requirements of the State of California Department of Health Services (DHS) for public water systems,
- Pumping facilities, such as pump stations, booster pumps, and appurtenances, to be designed maintain the sanitary quality of the pumped water,
- Water storage structures provide stability, durability, and protect the quality of the water.

The design criteria and standards contained in this document are based on the provisions of the California Code of Regulations (CCR), Titles 17 and 22. The designer should be aware that DHS is in the process of amending these provisions by adopting its own water works standards. DHS' draft California Water Works Standards dated December 2, 2002 is scheduled for adoption by 2004.

PART 1 - GENERAL

1.1 MASTER PLAN

A master plan shall be developed for potable water piping network to serve the entire built-out development area. At a minimum, the plan should be reviewed and approved by a licensed Professional Engineer and include details on capacity, storage, pumping requirements, demand projections, backflow protection, piping layout, and other planning features.

For each phase of the development, a separate plan shall be developed to serve the development within the phase. Plans developed for phases shall be consistent with the master plan.

1.2 DESIGN WATER PRESSURE & FLOW

All potable water mains shall be designed to water pressure and flow for maximum domestic daily demand plus fire flow requirements in accordance with CCR, Title 22,

**DRAFT Design Criteria and Standards
Low Pressure Domestic Water System
Hunters Point Shipyard**

Section 64566, System Pressure. Fire flow and residual pressure shall be as required by SFFD.

1.3 REFERENCE STANDARDS

- A. Standard Specifications of the City and County of San Francisco (the City), Department of Public Works (DPW), Bureau of Engineering (BOE), dated July, 1986. Also referred to as "City Standard Specifications."
- B. Standard Plans of the City, DPW, BOE, dated September 1987. Also referred to as "City Standard Plans."
- C. DPW Order No. 171,442 "Regulations for Excavations and Restoring Streets in San Francisco", approved January 1, 1999.
- D. American Water Works Association (AWWA) Standards, Latest Revision.
- E. San Francisco Water Department (SFWD) standard drawings, SFWD Rules and Regulations governing water services to customers.
- F. CCR, Title 17 and 22.
A copy of CCR, Title 17 and 22 can be found on the DHS website located at <http://www.dhs.cahnet.gov/ps/ddwcm/publications/regulations/bluebook3-11-02.pdf>.
- G. DHS' Draft Water Works Standards dated December 2, 2002. A copy of this document can be found on the DHS website located at <http://www.dhs.cahnet.gov/ps/ddwcm/publications/regulations/waterworksregdraft12-10-02.pdf>.
- H. DHS' California Safe Drinking Water Act and Related Laws, 7th Edition, January 1, 2000.
- I. San Francisco Public Utilities Commission (SFPUC) Water Quality Bureau (WQB) Standard Disinfection and Sanitary Work Practices, latest edition.

1.4 SUBMITTALS

The SFPUC requires that all reports, plans and specifications for a public water system be submitted at least 30 days prior to the date when their approval is desired.

Documents submitted for formal approval must include, but not be limited to:

- a. Summary of the basis of design, including maximum day demand, fire flow requirements, required capacity, pressure, storage and pumping requirements.
- b. Design criteria and selection of materials and installation methods for water mains, valves, hydrants, air valves, meters and blow-off valves, backflow

**DRAFT Design Criteria and Standards
Low Pressure Domestic Water System
Hunters Point Shipyard**

preventers, cathodic protection, separation between water mains, sanitary and storm sewers, cross-connections and interconnections, water services and plumbing, and service meters.

- c. Operation requirements, where applicable,
- d. General layout showing the extent of the proposed system
- e. Detailed plans,
- f. Detailed specifications,
- g. Documentation that owner is committed to providing as-built certification of the project by a registered professional engineer.

The designer is responsible to obtain all other necessary permits for construction, waste discharges, etc., required by other federal, state, or local agencies. No approval for construction can be issued until final, complete, detailed plans and specifications have been submitted to the reviewing authority and found to be satisfactory. Three sets of the final plans and specifications must be submitted for review. An approved set will be returned to the applicant.

PART 2 - PRODUCTS

Ductile iron, copper and brass products listed hereinafter are currently used by SFWD for the installation of water mains and services in soil commonly found in San Francisco. Ductile iron, copper and brass specifications and related installation may or may not apply for HPS.

2.1 DISTRIBUTION AND FEEDER MAINS

- A. Due to potentially corrosive soil, tidal effects and geologic characteristics in the HPS area, the Developer shall perform a study or investigation of the site-specific conditions and propose the most appropriate pipe materials to be used. Emphasis shall be made on corrosion protection. Water main materials and coatings shall be certified by the National Sanitary Foundation (NSF) and shall comply with Sections 64622 and 64624 of CCR Title 22.
- B. Minimum size of water mains shall be 6 inches when the reach is in a residential area and terminating at a cul-de-sac or dead end street and 8 inches when the reach is greater than 2,000 feet. When the reach is serving a fire hydrant, the minimum size shall be 6 inches. Pipe diameters of 8, 12 and 16 inches are required for all other distribution and feeder mains. Pipe diameters of 10 and 14 inches should not be used.
- C. For information purposes, the SFWD uses ductile iron, Class 53, double cement lined (inside), asphaltic outside coating and conforming to the latest revision of the American National Standards Institute (ANSI)/AWWA C151/A21.51-96, Tyton joint with U.S. Pipe "Field-Lok™" gasket.

**DRAFT Design Criteria and Standards
Low Pressure Domestic Water System
Hunters Point Shipyard**

2.2 SERVICE PIPES

- A. The allowable diameters for service pipes are 1, 2, 4, 6, 8, and 12 inches. Pipe diameters of 3 inches and less than 1-inch should not be used.
- B. Service pipes shall be copper tubing type K, soft or hard, for 1 inch and 2 inch sizes and ductile iron for larger sizes.
- C. Fittings shall be made of bronze or brass, in conformance with AWWA C-900.
- D. Service connection pipe and fittings shall be designed for cold water working pressure of not less than 150 pounds per square inch gage [psig, 1, 030 kilo-Pascal gage (kPag)] in accordance with Section 64644 of CCR Title 22. Copper tubing shall be commercial designation type K. Plastic tubing and fittings shall be products tested and certified as suitable for use in potable water piping systems by the NSF Testing Laboratory, the Canadian Standards Association Testing Laboratory or another testing agency acceptable to the Department

2.3 GATE VALVES

Gate valves shall be Tyton by Tyton ends, with US Pipe "Field-Lok" gaskets, resilient seated, non-rising stem, right turn open and nut operated.

2.4 DUCTILE IRON FITTINGS

SFWD is using ductile iron fittings to connect ductile iron pipes.

Ductile iron fittings conform to the latest revision of ANSI/AWWA C110/A21.10-98. Fittings are Tyton by Tyton ends with U.S. Pipe "Field-Lok" type gaskets.

2.5 JOINT RESTRAINT DEVICES

Joint restraint devices shall be per SFWD standard drawings, except that bolt, nut and tie-rods shall be stainless steel TP304.

2.6 AIR OR BLOW-OFF VALVE

Air valves and blow-off valves shall be manual type and the assembly shall be as shown in the SFWD standard drawing and in accordance with Section 64636, Air Vacuum Relief and Air Release Valves, of CCR Title 22. Also see attached SFWD Standard Drawing for Air and Blow-off Valves.

**DRAFT Design Criteria and Standards
Low Pressure Domestic Water System
Hunters Point Shipyard**

2.7 METER BOXES AND COVERS

Meter boxes and covers for standard (domestic) services shall be made of polyethylene and polymer concrete. Meter boxes and covers shall be manufactured by Armorcast or equivalent.

2.8 HYDRANT, HYDRANT BURY, BREAK AWAY

Hydrant, hydrant bury and break away shall be as required by SFFD. Hydrants shall be painted as required by SFFD.

2.9 BACKFLOW PREVENTER

The type of backflow preventer shall be determined by the SFWD, Water Quality Bureau (WQB). The backflow preventer shall be designed and installed in accordance with Sections 7601, 7602, 7603, and 7604 of CCR Title 17, and City Ordinance 356 - 84, Article 12A.

PART 3 - EXECUTION

3.1 INSTALLATION OF WATER MAINS

- A. Potable water mains and their appurtenances shall be located in areas accessible to SFWD personnel, SFFD fire engines and maintenance vehicles and equipment for maintenance, repair, and servicing at all times. Mains shall be located within public right-of-way and easements. For maintenance requirement, easement shall be 20 feet wide minimum.
- B. Potable water mains shall be located with the required horizontal and vertical separations from sewer lines in conformance with DHS and Section 64630, Water Main Installation, of CCR Title 22.
- C. Potable water mains laid in streets shall be located in the first traffic lane and no closer to the face of curb than four (4) feet. In any case, mains shall be located so that excavation and repair of the main or its appurtenances will not encroach on private property. Water mains should be laid out only in segmented grids and loops and located within streets. Dead-end water mains shall be installed only if:
 - 1. Looping or gridding is impractical due to topology, geology, pressure zone boundaries, unavailability or easements or location of users; or
 - 2. The main is to be extended in the near future and the planned extension will eliminate the dead-end conditions.

**DRAFT Design Criteria and Standards
Low Pressure Domestic Water System
Hunters Point Shipyard**

D. Potable water mains shall be interconnected or looped, unless otherwise allowed for un-looped lengths. Looping of potable water mains provides a grid layout or network of piping that provides increased reliability of a potable water supply system. Looping allows reaches to be supplied from each end of the reach, allows confining loss of service due to pipe breaks to small sections by valves, and allows repair and expansion of the system with minimum service disruption to customers.

E. Potable water mains installed below ground shall have the following minimum cover:

<u>Pipe Size</u>	<u>Minimum Cover</u>
8-inch or less	30 inches
12 and 16-inch	32 inches

F. Minimum pipe trench widths shall be as follows:

<u>Pipe Size</u>	<u>Minimum Trench Width</u>
4, 6, and 8-inch	18 inches
12-inch	24 inches
16-inch	30 inches

G. Depending on the type of native soil, a 3-inch thick layer of imported backfill material for bedding may be required and a 6 to 12 inch thick layer of imported material over the top of the pipe may be required.

H. Trench shall be excavated so that the barrel of the pipe will have an even bearing along its entire length. Bell holes shall be excavated for each bell or joint.

I. Before any pipe may be installed, the grade of the trench bottom shall be to the satisfaction of the SFWD. Immediately prior to installing the pipe, the contractor shall remove all loose rocks and other objectionable material from the bottom of the trench and bell holes. When the trench is properly prepared, the pipe shall be lowered therein, singly, without jar or strain and assembled by piece inside the trench.

J. Backfill material shall consist of dune sand or equivalent, free from rock, concrete, organic material and other objectionable material. Backfill material shall have 100 percent (%) passing the 3/8" sieve, 93% to 100% passing the number 4 (No. 4) sieve, and 0% to 10% passing the No. 200 sieve size.

**DRAFT Design Criteria and Standards
Low Pressure Domestic Water System
Hunters Point Shipyard**

- K. Joints for pipe shall be fastened by use of "Field-Lok" Gaskets unless otherwise directed by the SFWD. The Contractor shall identify all joints with "Field-Lok" gaskets by spraying white marking paint on top of each bell and also by taping a direct burial tape around the spigot end of each pipe, just in front of the bell.
- L. In curved streets, horizontal and vertical curves for water mains shall be formed by pulling the joints, by bending the pipes or by the use of fittings. The angle of deflection shall not exceed 2 degrees, and the bending radius shall be 300 feet minimum.
- M. When the pipe is cut in the field, the outside of the cut end shall be beveled about one-quarter inch at an angle of about 30 degrees and the leading edge rounded. The prepared cut end shall be marked at 3-5/16" for a 12" water line.
- N. Thrust blocks shall be installed on pipes larger than 12" diameter at all fittings or angular bends of 11-1/4 degrees or larger. No thrust blocks required for lines 12" in diameter and smaller, except at fire hydrant laterals, which do require thrust blocks.
- Thrust blocks shall be designed to resist the thrust reaction forces at the bends or fittings whose magnitude will depend on the pipe diameter and internal pressures and allowance for water hammer. Thrust blocks shall be designed to transfer and distribute the thrust forces to the undisturbed soil surface. Surface bearing capacity of soil shall be as determined and recommended by a soil investigation or report. Thrust block shall be designed with a minimum factor of safety of 1.25.
- O. All connections to existing water mains will be made by the SFWD at cost to the Developer. The Developer will be responsible for all excavation, shoring and pavement restoration. The Developer's contractor shall coordinate with the SFWD to facilitate connection of the new and existing system.
- P. The entire pipe system, including service laterals, shall be encased with polyethylene tubes or sheets in accordance with ANSI/AWWA C105/A21.5-99.
- Q. All joints on 4 inch or larger service laterals shall be restrained per SFWD Standards to and including the isolation valves.

3.2 INSTALLATION OF VALVES & VALVE BOXES

3.2.1 GATE VALVES

- A. Gate valves shall be designed in accordance with AWWA C500-93. Gate valves shall be located on all branches of the main including services that are 4-inches or larger. Each fire hydrant shall be provided with an isolating valve. In

DRAFT Design Criteria and Standards
Low Pressure Domestic Water System
Hunters Point Shipyard

addition, on long distribution mains, valves shall be installed at a minimum of 500 feet in commercial areas and no more than one block apart or within an interval of 800 feet in other areas. Dead ends for future expansion shall be provided with a valve. All taps to existing mains shall be provided with valves.

- B. Valves on service pipes 2-inch or less shall be "corporation stop" type and buried. Corporation stops shall be tapped into the main as shown on standard drawing.

3.2.2 AIR OR BLOW-OFF VALVES

- A. All air and blow-off valves shall meet all DHS requirements and shall be designed in accordance with Section 64636 Air and Vacuum Relief and Air Release Valves and Section 64642 Flushing Valves and Blow-Offs of CCR Title 22.
- B. The potable water distribution system shall be designed to minimize high points where air can accumulate. All high points in the distribution system shall be provided with air release valves. The air release valves shall not allow the accumulation of entrapped air at the high point, which will restrict water flow. Air valves shall also be installed next to a shut-off valve, at the high end of the segment isolated by two gate valves.
- C. Blow-offs shall be installed at all low points and dead ends. Blow-offs shall also be installed to a shut-off valve, at the low end of the segment isolated by the two gate valves.

3.2.3 VALVE BOXES & COVERS

- A. Valve boxes and covers shall be as per SFWD standard drawings.

3.3 INSTALLATION OF PIPE FITTINGS

- A. All fittings shall be installed in the manner specified for installing pipe under Item 3.1.
- B. All joints for ductile iron pipes and fittings shall be fastened to the pipe or to each other by use of Field-Lok gaskets. Caps shall be fastened to the pipe by use of tie rods and lugs or restrainers as shown on SFWD Standard Drawing E-4969.
- C. Joints on all laterals to the main shall be restrained per SFWD standard drawing.
- D. All tie rods, lugs, restraining ring assembly, bands and other miscellaneous metal attached to the pipeline and hydrant bury, installed by the Contractor and

**DRAFT Design Criteria and Standards
Low Pressure Domestic Water System
Hunters Point Shipyard**

by the Water Department during main connections, or large service connections shall be painted with two (2) coats of Kopper Bitumastic No. 505 or two (2) coats Protecto Wrap CA160, applied in accordance with the manufacturer's recommendations.

3.4 INSTALLATION OF HYDRANTS

- A. The installation of hydrants shall be performed in accordance with Section 64640 of CCR Title 22.
- B. The location of fire hydrants shall be as approved by SFFD.
- C. Hydrants shall be installed near the street curb, shall be accessible to fire trucks, and protected from traffic. Hydrants shall be located at a distance of 24" minimum and 27" maximum from the face of curb, and at least four (4) feet from a utility pole, traffic control box, or fixed object or structure.
- D. In addition to "Field-Lok" gaskets, all joints on hydrant laterals shall be restrained as shown on SFWD standard drawing.

3.5 HYDROSTATIC PRESSURE TEST

- A. Pressure tests shall be performed by the Developer or the Developer's contractor. Temporary anchors may have to be installed to prevent pipe movement during the test. Pipelines shall be tested to a hydrostatic pressure of 225 pounds per square inch (psi). The actual pressure test of 225 psi shall be maintained for at least 2 hours during which time no additional water shall be added to the line under test. Unless otherwise directed by the Engineer, the pipe joints shall be exposed during the test. All service lines to be incorporated in the pipeline shall be installed before the pipeline may be tested and shall be included in the test. At locations where the operating pressure is greater than 150 psi, the test pressure shall be 1.5 times the operating pressure.
- B. If any section of the pipe being tested develops a leak that is visible to the eye in the rubber gasket joints or in the pipe itself, the defective joint or portion of pipe shall be repaired or replaced as directed by the SFWD. After all repairs are made, the pipe shall be retested.

3.6 DISINFECTION

- A. Upon completion of satisfactory hydrostatic test, the SFWD will disinfect the main at cost to the Developer. The SFWD will supply and install all piping, fittings and other materials necessary to chlorinate the main, except for screw taps and risers, which shall be installed by the Developer's contractor. The Developer's contractor shall not backfill the site of such work until the

**DRAFT Design Criteria and Standards
Low Pressure Domestic Water System
Hunters Point Shipyard**

satisfactory disinfection of the main is verified by the SFWD. Refer to WQB's Standard Disinfection and Sanitary Work Practices provided as Attachment A.

3.7 INSTALLATION OF SHORING

- A. The Developer's contractor shall install an approved shoring system for all excavations five (5) feet or more in depth.
- B. All shoring shall be installed in accordance with Standards established by the State of California Occupational Safety and Health Administration (CAL/OSHA) and in conformance with all other applicable rules and requirements.
- C. In locations where the Water Department crews will install main or service connections, regardless of depth, the Contractor shall install a solid sheeting type-shoring system, approved by the Developer or its contractor that is capable of protecting all excavations from excessive water that may be present and give ample access to the crews to perform the installation. This shoring system is more stringent than CAL/OSHA Standards.

3.8 INSTALLATION OF SERVICE PIPES

- A. New service to existing main connection. The SFWD shall install service pipe connections (corporation stop or isolation valve) to existing mains prior to service pipe installation at cost for the Developer.
- B. New service to new main connection. The Developer's contractor shall install service pipe connections to all new water mains.
- C. Installation of new service pipes. The Developer's contractor shall install service pipe and fittings to a point inside the meter box, and thence from the meter box to one foot beyond the back of sidewalk, or as otherwise directed by the SFWD. SFWD personnel will furnish and install the water meter at cost for the Developer.
- D. Each type of service (irrigation, domestic, fire) shall have a separate line and a meter.

3.9 INSTALLATION OF WATER METER

- A. The developer shall install service pipe up to and excluding the meter. SFWD will install the meter. The developer shall install house-pipe from the meter. The developer shall install meter box and cover.

**DRAFT Design Criteria and Standards
Low Pressure Domestic Water System
Hunters Point Shipyard**

- B. Pipes installed by the developer upstream of the meter shall be pressure tested before the installation of the meter by SFWD. Meters and meter boxes shall be installed near the curb, on the first flag on the sidewalk.
- C. Sizes of meter boxes shall be as shown hereinafter:

<u>Meter</u>	<u>Size of Meter Box</u>
5/8" to 1"	20" x 14" outside dimensions
1-1/2"	27" x 18"
2"	35" x 22"
4" & 6"	36" x 80" x 30"
8" & 10"	36" x 90" x 30"

3.10 INSTALLATION OF FIRE SERVICES

- A. The Developer shall contact the SFWD WQB Cross-Connection Control Section regarding backflow preventer requirements on fire sprinkler systems. The Developer shall install backflow preventers for fire sprinkler services that are approved by SFWD WQB. A 3/4" meter shall be installed on the bypass by SFWD personnel. Backflow preventers shall be installed inside private properties.

3.11 INSTALLATION OF LOCATING/MARKING TAPE

- A. The locating/marketing tape shall be installed in the trench continuously over the centerline of the pipe, 12" above the top of the pipe. The tape shall be oriented longitudinally, and centered along the top of the pipe, with the printed side facing up. Necessary precautions shall be taken to insure that the tape is not twisted or misplaced during backfilling.

3.12 WATER MAIN ABANDONMENT

- A. For existing 8-inch or smaller mains that are to be abandoned in place, the ends shall be plugged with grout and sealed with plastic to prevent future connection.
- B. For larger pipes to be abandoned in place, the entire pipe length shall be filled with slurry.

**DRAFT Design Criteria and Standards
Low Pressure Domestic Water System
Hunters Point Shipyard**

ATTACHMENT A

**WQB STANDARD SPECIFICATIONS
DRAFT 6-28-02**

SP-A1 DRINKING WATER SYSTEM COMPONENTS

No chemicals, materials, products, or equipment supplied under this contract for the treatment or distribution of drinking water including, but not limited to, process media (carbon, sand), protective materials (coatings, linings, liners), joining and sealing materials (solvent cements, welding materials, gaskets, lubricating oils), pipes and related products (pipes, tanks, fittings), mechanical devices used in treatment/transmission/distribution systems (valves, chlorinators, separation membranes), and mechanical plumbing devices (faucets, endpoint control valves) shall be in contact with a drinking water unless the chemical, material, or product has been tested and certified as meeting the specifications of American National Standard Institute/NSF International(ANSI/NSF) Standard 61-2001/Addendum 1.0-2001 (Drinking Water Treatment Chemicals—Health Effects). This requirement shall be met under testing conducted by a product certification organization accredited for this purpose by the American National Standards Institute.

The Contractor shall submit proof of ANSI/NSF Standard 61 certification for all chemicals, materials, products, or equipment supplied under this contract for the treatment or distribution of drinking water.

SP-A2 SANITARY WORK PRACTICES

The Contractor shall install pipelines and appurtenances in a manner to prevent animal, physical, biological, and chemical contamination.

- A. The Contractor shall establish sanitary controls in accordance with AWWA Standards C651-99, Section 4.3, Preventative And Corrective Measures During Construction.
- B. All domestic water pipelines shall be stored so that the ends are capped with removable plastic caps to prevent dirt or other foreign material from entering the system. Plugs of rags, wood, cotton or similar materials are not acceptable.
- C. All materials stored on site shall be kept in a clean and undamaged condition. Material shall be stored off the ground and away from any standing water. Valves and other appurtenances shall be kept wrapped in plastic or other protective material until installation.
- D. Prior to installation of any pipelines, valves, or appurtenances, all plugs, caps, dirt, debris, grease and foreign material shall be removed. If dirt has entered the pipe, Contractor shall wash components with potable water.

**DRAFT Design Criteria and Standards
Low Pressure Domestic Water System
Hunters Point Shipyard**

- E. All equipment, facilities, and pipelines to be installed shall be kept clean subject to the approval of the Engineer. If the Engineer finds unacceptable care or cleanliness of facilities, the Engineer may require the facilities to be cleaned, at no charge to the City, prior to installation and/or being put into service.

SP- A3 DISINFECTION OF PIPELINES, PUMP STATIONS, AND WELLS

All pipelines pump stations, and wells that convey potable drinking water shall be disinfected prior to being placed into service.

- A. After installation of pipelines and appurtenances, Contractor shall conduct Field Testing per Section 3.5, Pressure Test. Following this task, SFPUC personnel will perform a final disinfection on facilities that convey potable drinking water per AWWA Standards for the disinfection of pipelines, pump stations, or wells.
- B. The Contractor shall notify the Engineer two weeks prior to a facility being ready for disinfection. The Contractor shall coordinate construction activities with the Engineer for coordination with SFPUC personnel conducting the disinfection. The Contractor shall assist and provide support and equipment to the SFPUC as needed. The Contractor shall be required to provide minor assistance to SFPUC personnel.
- C. Time allowance for disinfection, including filling, disinfecting, flushing, and bacteriological analysis of the facility shall be estimated in calendar days and provided to the City. If the specified bacteriological analyses are not satisfied, the disinfection procedure will be repeated until the requirements are met at no additional cost to the City.
- D. Bacteriological Analyses of Water. After completion of the disinfection procedure, the Engineer will obtain water samples for bacteriological analyses by the City. Requirements for satisfactory disinfection of water supply are that bacteriological analyses (heterotrophic plate) shall indicate that water samples are negative for coliform bacteria. If bacteriological analyses do not satisfy the above requirements, then disinfection procedures will be repeated until these requirements are met, at no additional cost to the City.

SP-A4 DISINFECTION AND WATER QUALITY TESTING FOR TANKS AND RESERVOIRS

- A. Contractor shall not introduce into the tank or reservoir any substances that do not meet NSF 61 approval (i.e., not specifically approved for use in drinking water - in particular thinners, solvents, paint products or other materials that contain toxic substances or that will result in exceeding the specified standards for regulated and unregulated volatile organic compounds (VOCs).

**DRAFT Design Criteria and Standards
Low Pressure Domestic Water System
Hunters Point Shipyard**

- B. Contractor shall allow complete curing of the tank or reservoir interior coatings and sealant according to manufacturer's recommendations.
- C. After tank/reservoir interior coating and sealant is applied and cured and all interior tank/reservoir appurtenances installed, the inlet/outlet line and all interior tank/reservoir surfaces are to be cleaned according to the following procedures.
1. Contractor shall pressure wash and mechanically (brush) clean as required all interior tank/reservoir surfaces including the tank/reservoir ceiling, rafters, walls, floor, and all other interior metal attachments of all adhered dust, overspray, and contaminants and remove all rinse water from the tank/reservoir. This operation is to continue until the rinse water contains no visible turbidity. Contractor shall store and/or dispose of this rinse water. Removal and disposal of this rinse water shall be at the Contractor's expense. If acceptable, rinse water shall be flushed into an approved discharge point that is specified by the Engineer.
 2. Contractor shall clean the portion of the inlet/outlet line from the tank/reservoir floor to the main valve in the valve pit. This cleaning operation shall be performed using a high pressure jet and vacuum line, and will be continued until rinse water vacuumed from the inlet/outlet line contains no visible turbidity, spent media or other contaminants. Contractor shall store and/or dispose of this rinse water. Removal and disposal of this rinse water shall be at the Contractor's expense. If acceptable, rinse water shall be flushed into an approved discharge point that is specified by the Engineer.
 3. Following the final cleaning of the wash water tank, any personnel (Contractor or SFPUC) entering the tank shall follow sanitary practices. These practices shall include
 - a. Clean step-on/step off pad and control access in and out of areas under sanitary control. Clean rubber boots must be used, dripped in a disinfection solution of 10,000 milligrams per liter [mg/L, (1% free chlorine)] prior to each entry into areas under sanitary controls.
 4. The Contractor shall notify the Engineer in writing a minimum of 10 working days before a cleaning inspection, is required. During the cleaning inspection the Contractor shall provide adequate ground supported scaffolding and lighting, as determined by the Engineer, to facilitate visual inspection by the Engineer of the completed work. Lighting shall be placed as directed by the Engineer to minimize glare and shadows. The Contractor shall provide personnel to move scaffolding and furnish other assistance that the Engineer may require for his inspection. The Engineer will then conduct a detailed inspection of all interior work and coordinate water quality testing and disinfection with City personnel.

**DRAFT Design Criteria and Standards
Low Pressure Domestic Water System
Hunters Point Shipyard**

- D. After the Engineer approves cleaning, SFPUC personnel shall conduct disinfection and water quality testing as defined herein. If the tank or reservoir fails preliminary or final water quality testing then the Contractor shall take remedial measures as required to meet specified water quality testing. These remedial measures may include aeration utilizing a compressor with an oil separator, draining and cleaning the tank, reapplication of coating or sealant, refilling of the tank or any combination of these remedial measures as determined by the Engineer. It is presumed that any failure to meet the minimum water quality standards, as defined in this section, are due to foreign constituents introduced into the tank by the Contractor and/or by improper application of the specified materials. All costs and time associated with meeting the minimum water quality standards specified in this section are the sole responsibility of the Contractor and no additional payment will be made to meet these standards.

1. The City will perform all disinfection and water quality testing as follows:

- a. Preliminary Water Quality Testing. This phase includes filling of the tank for the designated low level soak (approximately 3' – 4' level as determined by the Engineer). The Engineer arranges for tank water samples after a 5-calendar day hold period VOCs tests; tests will be run for Title 22 regulated and unregulated organic compounds.

Test Standards for VOCs. The passing criteria for VOCs require that the VOC level in any sample for all regulated and unregulated chemicals, as listed in the Title 22 Code of Regulation be less than the Maximum Contaminant Level (MCL) listed. Additionally, the total VOCs in any sample taken must not exceed 50 micrograms per liter ($\mu\text{g}/\text{l}$). If tests are satisfactory, the tank will be drained then disinfected as indicated herein. If test results are unsatisfactory, Contractor shall take remedial measures as required, at Contractor's expense, to meet the specified water quality standards. Following remedial measures, the Engineer will reschedule preliminary water quality testing as described above.

- b. Tank Disinfection and Final Water Quality Testing. The City will provide disinfection in accordance to AWWA Standard for Disinfection of Water Storage Facilities. Following the tank disinfection, the Engineer will arrange for tank water samples to be tested for coliform bacteria. All samples tested or bacteriological quality in accordance with Standard Methods for the Examination of Water and Wastewater shall show the absence of coliform bacteria. Any sample that is invalid or positive for coliform is considered to be a failed test. If test results are satisfactory, the tank is placed in service. If test results are unsatisfactory, contractor shall take remedial measures as required, at Contractor's expense, to meet the specified water quality standards. Following remedial measures, the

**DRAFT Design Criteria and Standards
Low Pressure Domestic Water System
Hunters Point Shipyard**

Engineer will reschedule disinfection and final water quality testing as described above.

— End of Section —

**DRAFT Design Criteria and Standards
Reclaimed Water System
Hunters Point Shipyard**

Foreword

The standards provided herein are intended to serve as a guide in the preparation of design plans and specifications for the reclaimed water supply system at Hunters Point Shipyard (HPS). The use of reclaimed water should not be provided for public consumption, as it poses a greater public health risk than potable water. Thus, the use of reclaimed water requires greater public awareness, notification, in addition to more careful planning and review.

The design criteria and standards contained in this document are based on the provisions of the California Code of Regulations (CCR), Title 17 and 22. The designer should be aware that the Department of Health Services (DHS) is in the process of amending these provisions by adopting its own water works standards. DHS' draft California Water Works Standards dated December 2, 2002 is scheduled for adoption by 2004.

PART 1 - GENERAL

1.1 MASTER PLAN

The master plan should specify, but not be limited in describing, planned uses (irrigation, dual systems, fire fighting, construction, etc.), backflow prevention plan, plan for labeling mains and appurtenances, and public posting and notification. Planned uses should be conforming to the level of treatment provided to the recycled water per California Code of Regulations (Title 17 and Title 22).

For each phase of the development, a separate plan shall be developed to serve the development within the phase. Plans developed for phases shall be consistent with the master plan.

1.2 DESIGN

The design criteria for reclaimed water are the same for potable low-pressure domestic water except where specified herein.

1.3 REFERENCE STANDARD

- A. Standard Specifications of the City and County of San Francisco (the City), Department of Public Works (DPW), Bureau of Engineering (BOE), dated July 1986. Also referred to as "City Standard Specifications."
- B. Standard Plans of the City, DPW, BOE, dated September 1987. Also referred to as "City Standard Plans."

**DRAFT Design Criteria and Standards
Reclaimed Water System
Hunters Point Shipyard**

- C. DPW Order No. 171,442 "Regulations for Excavations and Restoring Streets in San Francisco", approved January 1, 1999.
- D. American Water Works Association (AWWA) Standards, latest revision.
- E. San Francisco Water Department (SFWD) standard drawings, SFWD Rules and Regulations governing water services to customers.
- F. SFWD's Design Criteria and Standards – Low Pressure Domestic Water Design Criteria
- G. CCR, Titles 17 and 22. A copy of CCR, Title 17 and 22 can be found on the DHS website located at <http://www.dhs.cahnet.gov/ps/ddwcm/publications/regulations/bluebook3-11-02.pdf>.
- H. DHS' Draft Water Works Standards dated December 2, 2002. A copy of this document can be found on the DHS website located at <http://www.dhs.cahwnet.gov/ps/ddwcm/publications/regulations/waterworksregdraft12-10-02.pdf>.
- I. DHS' California Health Laws Related to Recycled Water, also known as "The Purple Book," excerpts from the Health and Safety Code, Water Code, and Titles 17 and 22 of the CCR, dated June 2001.
- J. San Francisco Plumbing Code, latest revision.

1.4 SUBMITTALS

The San Francisco Public Utilities Commission (SFPUC) requires that all reports, plans and specifications for a public water system be submitted at least 30 days prior to the date when their approval is desired.

Documents submitted for formal approval must include, but not be limited to:

- a. Summary of the basis of design, including maximum day demand, required capacity, pressure, storage and pumping requirements.
- b. Design criteria and selection of materials and installation methods for mains, valves, hydrants, air valves, meters and blow-off valves, backflow preventers, cathodic protection, separation between water mains, sanitary and storm sewers, cross-connections and interconnections, water services and plumbing, and service meters.
- c. Operation requirements, where applicable,
- d. General layout showing the extent of the proposed system
- e. Detailed plans,
- f. Detailed specifications,

**DRAFT Design Criteria and Standards
Reclaimed Water System
Hunters Point Shipyard**

g. Documentation that owner is committed to providing as-built certification of the project by a registered professional engineer.

The designer is responsible to obtain all other necessary permits for construction, waste discharges, etc., required by other federal, state, or local agencies. No approval for construction can be issued until final, complete, detailed plans and specifications have been submitted to the reviewing authority and found to be satisfactory. Three sets of the final plans and specifications must be submitted for review. An approved set will be returned to the applicant.

PART 2 - PRODUCTS

2.1 PLASTIC WRAP

A. Reclaimed water pipe shall be wrapped with purple plastic in accordance with AWWA C105/A21.5-99.

2.2 LOCATING / MARKING TAPE

A. Provide locating/marketing tape in the trench, continuously over the centerline of the pipe. Color-coded identification tape differentiating the reclaimed water piping from other utility lines shall be consistent throughout the project. Reclaimed water pipes shall be installed with a purple identification tape of polyethylene vinyl wrap, such as Pantone 512 or equivalent. The identification tape shall be locator-type marking tape. The tape and wrap shall be at least three (3) inches wide and shall have white or black printing on a purple field with the following inscription:

"RECLAIMED WATER – DO NOT DRINK" plus a universal icon for non-potable water

The text shall be separated by space of more than 6 inches. If the tape is wrapped around the pipe, there shall be two parallel rows of text so that the warning is readable after overlapping. Identification tape shall be continuous in coverage. If tape is attached to sections of pipe before they are placed in the trench, there shall be extra lengths of flaps to provide continuous coverage when the section is installed.

2.3 VALVES and VALVE BOXES

A. Valves shall be epoxy coated and purple in color. Valves shall be identified with a stamped brass or engraved plastic disc not less than 1.5 inches in diameter that is permanently affixed to the valve with the inscription:

**DRAFT Design Criteria and Standards
Reclaimed Water System
Hunters Point Shipyard**

"RECLAIMED WATER" plus a universal icon for non-potable water

- B. Valve box shall be a ductile iron frame and a matching cover. Valve box assembly shall be as per the auxiliary water supply system (AWSS) standards for hydrant valve, in "City Standard Plans" book. Cover shall be triangular shape, with the following inscription cast on the top.

"RECLAIMED WATER" plus a universal icon for non-potable water

2.4 RECLAIMED WATER METER

- B. Reclaimed water meter shall be purple in color. Meters shall be identified with a stamped brass or engraved plastic disc not less than 1.5 inches in diameter that is permanently affixed to the valve with the inscription:

"RECLAIMED WATER" plus a universal icon for non-potable water

PART 3 - EXECUTION

3.1 INSTALLATION OF RECLAIMED WATER

- A. The installation criteria for reclaimed water are the same as that for portable low-pressure domestic water except specified hereinafter.
- B. Reclaimed water lines shall maintain the minimum separation distances from potable water lines as the separation between a sewer line and a domestic water main in conformance with DHS' requirements contained in Section 64572 of the Draft California Water Works Standard and listed below.
 - 1. New water mains and new supply lines shall be installed at least 10 feet horizontally from, and one foot vertically above, any parallel pipeline conveying:
 - a. Untreated sewage,
 - b. Primary or secondary treated sewage,
 - c. Disinfected secondary-2.2 recycled water (defined in Section 60301.220),
 - d. Disinfected secondary-2.3 recycled water (defined in Section 60301.225), and
 - e. Hazardous fluids such as fuels, industrial wastes, and wastewater sludge.
 - 2. New water mains and new supply lines shall be installed at least 4 feet horizontally from, and one foot vertically above, any parallel pipeline conveying:

**DRAFT Design Criteria and Standards
Reclaimed Water System
Hunters Point Shipyard**

- a. Disinfected tertiary recycled water (defined in section 60301.230), and
 - b. Storm drainage.
3. New supply lines conveying raw water to be treated for drinking purposes shall be installed at least 4 feet horizontally from, and one foot vertically below, any water main.
 4. If crossing a pipeline conveying a fluid listed in subsection 1 or 2, a new water main shall be constructed perpendicular to and at least one foot above that pipeline. No connection joints shall be made in the water main within eight horizontal feet of the fluid pipeline.
 5. The vertical separation specified in subsections 1, 2, and 3 is required only when the horizontal distance between a water main and pipeline is ten (10) feet or less.
 6. New water mains shall not be installed within 100 horizontal feet of any sanitary landfill, wastewater disposal pond, or hazardous waste disposal site, or within 25 feet of any cesspool, septic tank, sewage leach field, seepage pit, or groundwater recharge project site.
 7. The minimum separation distances set forth in this section shall be measured from the nearest outside edge of each pipe.
- C. The locating/marketing tape shall be installed in the trench continuously over the centerline of the pipe, 12" above the top of the pipe. The tape shall be oriented longitudinally, and centered along the top of the pipe, with the printed side facing up. Necessary precautions shall be taken to insure that the tape is not twisted or misplaced during backfilling.

-- End of Section --

**DRAFT Design Criteria and Standards
Sanitary and Storm Drain System
Hunters Point Shipyard**

Foreword

The standards provided herein are intended to serve as a guide in the preparation of design plans and specifications for the sanitary sewer collection and pumping system at Hunters Point Shipyard (HPS), to suggest limiting values for items upon which an evaluation of such plans and specifications may be made by the reviewing authority, and to establish, as far as practicable, uniformity of practice. The recommendations and preferences set forth in this document are used only to indicate desirable procedures or methods and serve as guidelines for designers. It is the ultimate responsibility of the designer to develop a system that provides for:

- The protection of receiving waters of untreated discharges from public rights of way and private property.
- The reduction in the volume of storm runoff into any public or private system.
- The protection of public health by preventing sewage backup, uncontrolled sewage discharge to any waters, and public and private property.
- The provision for surface drainage channels in dedicated easements at all sumps or cul-de-sacs in addition to normal sewer connections as relief for overflows to prevent flooding of adjoining property.
- Sewage and storm water collection, storage, and pumping structures and facilities that provide reliability, operability, maintainability, stability, durability, and redundancy.

It is important to note that although this document provides design criteria and standards for the use of a combined sanitary and storm drain systems, and a separated sanitary and storm drain systems, it does not include the process and requirements for amending the City and County of San Francisco (the City) Subdivision Code and Regulations (SCR).

The design shall be in accordance with the City's SCR, the City's Design Plans and Specifications, and the current Uniform Plumbing Code and Phase II NPDES requirements. The reports, plans, specifications for the proposed wastewater and storm systems shall be certified by a professional engineer registered in the State of California.

It is recommended that a preliminary concept of the wastewater collection system be submitted for review by the SFPUC prior to the preparation of the required final design report, construction plans, and specifications. The purpose of the preliminary submittal is to present the concept, factual data, including soil boring, controlling assumptions and considerations used for the functional planning of the proposed system.

**DRAFT Design Criteria and Standards
Sanitary and Storm Drain System
Hunters Point Shipyard**

This document compliments the design and construction guidelines for the other utility systems presented herein and should be used together as appropriate to eliminate conflicts. This document is designed to aid in meeting the requirements of the SFPUC. It must be emphasized that no single document can possibly present guidelines for all situations that will be encountered. The SFPUC shall have the ultimate authority to interpret this document and may direct modifications for specific situations.

PART 1 - GENERAL

The San Francisco Public Utilities Commission (SFPUC) requires that all reports, plans and specifications for the sanitary and storm drain system be submitted at least 90 days prior to the date when their approval is desired.

1.1 SUBMITTALS

Documents submitted for formal approval must include, but not be limited to:

- a. Summary of the basis of design,
- b. Design criteria and selection of materials and installation methods for mains, catch basins, manholes, pumps and valves, controls, air relief valves, meters and blow-off chambers, backflow preventers and sewage ejectors, cathodic protection, separation between water mains, sanitary and storm sewers, cross-connections and interconnections, structural storm water treatment systems including inline treatment units, ponds, basins, trenches, vegetative controls (wetlands, swales), and filtration and infiltration systems.
- c. Operation and maintenance requirements, where applicable.
- d. General layout showing the extent of the proposed system
- e. Detailed plans,
- f. Detailed specifications,
- g. Documentation that owner is committed to providing as-built certification of the project by a registered professional engineer.

The designer is responsible to obtain all other necessary permits for construction, waste discharges, etc., required by other federal, state, or local agencies. No approval for construction can be issued until final, complete, detailed plans and specifications have been submitted to the reviewing authority and found to be satisfactory. Ten sets of the final plans and specifications must be submitted for review. An approved set will be returned to the applicant.

**DRAFT Design Criteria and Standards
Sanitary and Storm Drain System
Hunters Point Shipyard**

1.2 REFERENCES

The following reports and standards should be used in the preparation of the sanitary and storm drain system design for HPS:

- A. "Subdivision Regulations, adopted by the Department of Public Works (DPW) Resolution No. 124,677," Bureau of Engineering (BOE), DPW, City and County of San Francisco, January 6, 1982.
- B. "Standard Specifications," DPW, BOE, revised November 2000.
- C. "Standard Plans," BOE, DPW, revised February 1, 2002.
- D. "Wastewater Pumping Station Reliability Recommendations," prepared for the San Francisco Bay Region California Regional Water Quality Control Board (RWQCB) by Black & Veatch, May 1994.
- E. "Minor Sewage Pump Station Standards Design Guide," prepared by the SFPUC Water Pollution Control (WPC) Division, latest revision.
- F. "Start at the Source – Design Guidance Manual for Stormwater Quality Protection", prepared for the Bay Area Stormwater Management Agencies Association (BASMAA) New Development Committee by Tom Richman and Associates, with Camp, Dresser, and McKee, and Professor Bruce Ferguson (University of Georgia), 1999.

PART 2 - IMPROVEMENT PLANS AND SPECIFICATIONS

Improvement Plans and specifications for sewer and storm work shall conform to the construction standards applying to work performed by the City and to the design standards described hereinafter consistent with the Plans and Plan Documents.

2.1 IMPROVEMENT PLANS

Improvement Plans shall show at least the following: Existing and future work shall be delineated and labeled accordingly.

- A. Abbreviations. Abbreviations where used shall be as follows:

V.C.P.	-	Vitrified Clay Pipe
R.C.P.	-	Reinforced Concrete Pipe
S.L.	-	Sewer Lateral
M.H.	-	Manhole

**DRAFT Design Criteria and Standards
Sanitary and Storm Drain System
Hunters Point Shipyard**

D.M.H.	-	Drop Manhole
O.G.	-	Official Grade (See drawing L-7215.2)
Inv.	-	Invert (Flow Line)
D.I.	-	Drainage Inlet
D.L.	-	Drainage Lateral

- B. Drawings. A general plan of the portion of the Project Area shown on the Tentative Map shall be submitted showing:
- (i) Location, with reference to street lines of all existing and proposed manholes, drop inlets, culverts, or other drainage appurtenances within the limits of the work.
 - (ii) Location of manholes.
 - (iii) Approximate location of side sewers and storm laterals with references to lot lines, and proposed sizes.
 - (iv) Official or proposed street grades and anticipated settlement.
- C. Profiles of all main sewers and storm drain lines shall be submitted showing:
- (i) Existing and proposed lines, with sizes noted thereon, together with manholes, and such structures as tapers, junctions, overflows, and diversion weirs.
 - (ii) Invert elevations of all existing and proposed lines at manholes and at grade changes.
 - (iii) Rim elevations of all manholes.
 - (iv) Pavement surface line or ground line on the centerline of lines.
 - (v) Stationing, including intersecting street lines.
- D. Standard Plans. Except as otherwise provided in the Plans or Plan Documents, all sewers, storm drains and appurtenances shall, wherever possible, be constructed in accordance with approved "Standard Sewer Plans." Copies of which may be obtained on application to DPW BOE. Plan of special structures or systems not covered by any Standard Sewer Plan must receive the approval of the City Engineer unless included in the Plans or Plan Documents.

**DRAFT Design Criteria and Standards
Sanitary and Storm Drain System
Hunters Point Shipyard**

2.2 SPECIFICATIONS

Sewer and storm drain specifications, typed on 8-1/2" x 11" paper, or other mutually agreed upon format, shall describe all requirements as to material and workmanship, and shall, except as otherwise provided in the Plans and Plan Documents, conform with the current Standard Specifications, which are on file in the City Engineer's Office. The Standard Specifications, or pertinent provisions thereof, may, for convenience, be incorporated into the Subdivision Specifications, or may be made a part thereof by reference. Except as otherwise provided in the Plan and Plan Documents, the provisions of the Standard Specifications shall constitute the minimum requirements.

The applicant shall deliver one set of reproducibles, and four sets of prints, and four sets of specifications to the General Manager, SFPUC for review with the Improvement Plans. One set of approved plans and specifications will be returned to the applicant.

2.3 FINAL ACCEPTANCE OF SEWERS AND STORM DRAINS

Final acceptance of sewers and storm drains intended for public use may be contingent upon an interior television inspection provided at the expense of the permittee. Ground water infiltration shall not exceed 170 gallons per day per acre (gpd/acre).

Upon completion of the project, the permittee shall provide the City with a reproducible copy and, if requested, microfilms or diskettes of the final record drawings. Microfilms shall be in accordance with the format utilized by the City. The films shall be delivered to the City for a permanent record.

2.4 SEWER, STORM OR AWSS EASEMENT

Where sewer, storm or auxiliary water supply system (AWSS) easements are required for sewer, storm or fire protection facilities, they shall be granted to the City and shall be for the exclusive use of the sewer, storm or AWSS facilities. Unless otherwise specified in the Plans or Plan Documents or authorized by the SFPUC General Manager, all easements shall be a minimum of fifteen (15) feet in width, five (5) feet to one side and ten (10) feet to the other side of the centerline of the sewer, storm or pipe. Easement grants shall follow the City's standard form which provides, in part, that the easement shall not be used for the erection of any structure, nor for any other purpose which will damage or interfere with the proper use, function, maintenance, repair or replacement of the sewer or storm appurtenances or AWSS facilities.

Fences may be constructed and maintained on the easement, but the City reserves the right of immediate access without any requirement for notification, clearance or permission.

**DRAFT Design Criteria and Standards
Sanitary and Storm Drain System
Hunters Point Shipyard**

**PART 3 - RECOMMENDED STANDARDS OF DESIGN FOR SEPARATE
SANITARY SEWER SYSTEM**

3.1 GENERAL

Provision shall be made for the removal of sewage from each lot or parcel of land. Wherever "Standard Plans" are specified in this Section XIV, it shall mean San Francisco Standard Plans, except where they have been modified or superseded by the Plans or Plan Documents.

3.2 SANITARY SEWER MAINS

- A. Location: - Except where MUNI or other physical constraints dictate, sewers shall be located in the center of streets and lanes, unless otherwise permitted by the PUC General Manager.
- B. Depth and Cover: - The minimum depth of sewers shall be six (6) feet, except in unusual cases, when approved by the SFPUC General Manager, in which event, the minimum depth of the sewers in street areas shall not be less than three (3) feet in areas with concrete base and four (4) feet in areas of aggregate base in order to distribute surface loads and to provide space for utility service facilities.

For sewers located in the rear of lots or in easements not subject to surface traffic, the minimum depth of the trench shall be four (4) feet. Surface drainage in these areas shall be so designed that natural soil erosion does not result in a build-up of soil covering the manhole castings. This may be accomplished by designing the casting to rise slightly above the surrounding surface.

In order to provide backflow from the sewer main into improvements below street grade, gravity line from low basements to sewer mains should not be made. Back flow preventors should be installed in all properties below street grade. Installation of automatic sewage ejectors is advisable for such drainage.

- C. Types and Sizes - Sewers six inches (6") to twenty-one inches (21") in diameter shall be vitrified clay pipe (VCP) (ASTM C-700 Extra Strength). Sewers twenty-four inches (24") to thirty-six inches (36") in diameter may be VCP (ASTM C-700 Extra Strength) with construction modifications, or reinforced concrete pipe subject to the approval of the General Manager, SFPUC. Sewers larger than thirty-six inches (36") in diameter may be monolithic reinforced concrete or reinforced concrete pipe subject to the approval of the PUC General Manager.

Alternative pipe material for specific purposes and situations will be considered by the SFPUC General Manager.

**DRAFT Design Criteria and Standards
Sanitary and Storm Drain System
Hunters Point Shipyard**

- D. Joints – VCP sewers shall have bell and spigot joints with factory fabricated compression type fittings (ASTM C-425). Reinforced concrete sewer pipe (RCP) shall have bell and spigot or other approved joints.
- E. Alignment – All pipe sewers, VCP and RCP, shall generally be laid on straight lines and grades between manholes. Curved sewers will not be permitted.
- F. Encasement, Bedding, and Piling – All VCP sewers shall be placed on a crushed rock foundation. All VCP sewers on grades of thirty percent (30%) or greater shall be encased in reinforced concrete in accordance with Standard Plans, and concrete shall be placed against undisturbed ground.
- G. Settlement – Pipelines will be designed to comply with the criteria herein both at the time of construction and after 100% of the predicted fifty (50) year settlement.

3.3 MANHOLES

Manholes shall be located preferably at intervals of three hundred (300) feet but not more than three hundred fifty (350) feet and shall be provided at every change in size, grade, or alignment, at all junctions of sewers (except side sewers) and at ends of sewers.

Manholes shall be constructed in accordance with Standard Plans unless otherwise approved by the SFPUC General Manager:

3.4 SEWER CONNECTIONS

Y-branches and T-branches of vitrified clay shall be installed on all VCP sewers in locations described under the "side sewers" Section of these Regulations to provide connections for side sewers. In general they shall be six inches (6") in diameter for residential districts, and eight inches (8") minimum in diameter for industrial and commercial districts.

3.5 SIDE SEWERS

Unless otherwise permitted by the SFPUC General Manager, side sewers shall be installed in conjunction with construction of the main sewer and shall be extended one (1) foot beyond the curb and shall be in accordance with the San Francisco Plumbing Code.

Side sewers shall be provided and spaced as herein described. They shall generally be six inches (6") in diameter for residential areas and eight inches (8") minimum in diameter for industrial and commercial areas, and shall be laid on a uniform grade upward from the main sewer to a point twelve inches (12") beyond the curb line. This grade shall in no case be less than 1/4 inch per foot.

**DRAFT Design Criteria and Standards
Sanitary and Storm Drain System
Hunters Point Shipyard**

Where the street is to be paved before lot improvements are made, side sewer must be constructed beyond the curb before the paving is started. The upper end of each side sewer not in service when the work is backfilled shall be closed with a stopper, marked with a redwood post, and marked with the letter "S" on the curb.

**PART 4 - RECOMMENDED STANDARDS OF DESIGN FOR SEPARATE STORM-
DRAIN SYSTEM**

4.1 GENERAL

General provision shall be made for the removal of storm water from each lot or parcel of land, and storm water from all roads, streets, and sidewalks.

At all sumps or cul-de-sacs, in addition to normal storm drain connections, surface drainage channels in dedicated easements or surface drainage in streets shall be provided as relief overflows to prevent flooding of adjoining property.

Wherever "Standard Plans" are specified in this Section XV, it shall mean San Francisco Standard Plans, except where they have been modified or superseded by the Plans or Plan Documents.

4.2 STORM DRAINS

- A. Location – Storm drains shall typically be located off the center of streets to clear sanitary sewers in the center unless otherwise permitted by the General Manager SFPUC.
- B. Depth and Cover – the minimum depth of storm drains shall be not less than three (3) feet in areas of concrete base and four (4) feet in areas of aggregate base, except in unusual cases, when approved by the SFPUC General Manager, where additional support is provided over the pipe or reinforced or high strength pipe is used.

For storm drains located in the rear of lots or in easements not subject to surface traffic, these areas shall be so designed that natural soil erosion does not result in a build-up of soil covering the manhole castings. This may be accomplished by designing the casting to rise slightly above the surrounding surface.

Storm drains shall be designed to flow under surcharged conditions and, in the event of storms exceed the conduit design criteria, the surcharge may rise to the street for overland flow transport. In order to prevent backflow from the storm drain line into improvements below street grade, gravity line from low areas to storm drain lines should not be made. Backflow preventors should be installed in all properties below street grade. Installation of automatic main water ejectors is advisable for such drainage.

**DRAFT Design Criteria and Standards
Sanitary and Storm Drain System
Hunters Point Shipyard**

- C. Types and Sizes – Storm drains shall be RCP, 10" diameter minimum. Alternative pipe material for specific purposes and situations will be considered by the SFPUC General Manager.
- D. Joints – reinforced concrete storm drain pipe (RCP) shall have bell and spigot or other approved joints.
- E. Alignment – All pipe lines shall generally be laid on straight lines and grades between manholes. Curved lines will not be permitted.
- F. Settlement – Pipelines will be designed to comply with the criteria herein both at the time of construction and after 100% of the predicted fifty (50) year settlement.

4.3 MANHOLES

Manholes shall be located preferably at intervals of three hundred (300) feet but not more than three hundred fifty (350) feet and shall be provided at every change in size, grade, or alignment, at all junctions of storm drains (except side drains), at ends of storm drains, and where storm water inlet culverts join storm drains.

Manholes shall be constructed in accordance with Standard Plans unless otherwise approved by the SFPUC General Manager.

4.4 JUNCTION STRUCTURES

Junction structures shall be provided where concrete pipeline merge on change size.

4.5 CULVERTS

Connections to existing VCP sewers, and concrete pipe having a diameter less than forty-two inches (42"), shall be made at manholes only and in accordance with Standard Plans. Connections concrete pipe sewers, forty-two inches (42") or more in diameter, may be made directly into the sewer in accordance with Standard Plans and current City practice.

Culvert inverts shall generally be laid at a depth of two feet below pavement grade at the drop inlet, with a fall towards the manhole or sewer at a grade of less than two percent (2%).

4.6 DROP INLETS

Drop Inlets shall be provided at all low points and shall be so located in the gutter as to most effectively serve the adjacent drainage area.

Drop Inlets shall be spaced not more than six hundred (600) feet apart. Closer spacing and additional drop inlets if approved by the SFPUC General Manager may be required to

**DRAFT Design Criteria and Standards
Sanitary and Storm Drain System
Hunters Point Shipyard**

effectively drain the pavement. Multiple inlets shall be installed where required by the SFPUC General Manager.

Drop Inlets if approved by the PUC General Manager shall be constructed in accordance with Caltrans Standard Plans.

4.7 STORM DRAIN CONNECTIONS

Y-branches and T-branches shall be installed on all storm drain in locations described under the "side drains" Section of these Regulations to provide connections for side drains. In general they shall be eight inches (8") in diameter for residential districts, and ten inches (10") minimum in diameter for industrial and commercial districts.

4.8 SIDE DRAINS

Unless otherwise permitted by the SFPUC General Manager, side drains shall be installed in conjunction with construction of the main storm drain and shall be extended beyond the curb.

Side drains shall be provided and spaced as herein described. They shall generally be eight inches (8") minimum in diameter for residential areas and ten inches (10") minimum in diameter for industrial and commercial areas, and shall be laid on a uniform grade upward from the main storm chain to a point twelve inches (12") beyond the curb line. This grade shall in no case be less than 1/4 inch per foot.

The upper end of the side drain, at the curb, shall be of sufficient depth to provide adequate drainage for the property served and in no case shall the invert at the curb be less than two (2) feet below curb grade. Openings in the existing storm sewer shall be made with a sharp cutting tool, and an approved saddle of appropriate size shall be glued or strapped to the existing sewer. Side drains shall be located at the lowest elevation of the frontage of the property.

Where the street is to be paved before lot improvement are made, side drains must be constructed beyond the curb before the paving is started. The upper end of each side storm drain not in service when the work is backfilled shall be closed with a stopper, marked with a redwood post, and marked with the letter "SD" on the curb.

PART 5 - REQUIRED CAPACITY OF SEPARATED STORM DRAIN SYSTEM

5.1 DESIGN BASIS

Storm water drains shall have sufficient capacity, when flowing full or surcharged to carry the computed storm water runoff, based on the ultimate development of the area including the natural drainage from upstream areas. Flows for a storm frequency of up to five years will be carried in pipes. Storms of frequency greater than five years will be carried in the streets as overland flow. Infiltration into storm pipe will be calculated at 0.0003 times the flow.

**DRAFT Design Criteria and Standards
Sanitary and Storm Drain System
Hunters Point Shipyard**

5.2 MINIMUM SIZE

Main storm lines shall be a minimum of ten inches (10") in diameter unless otherwise permitted by the SFPUC General Manager.

5.3 HYDRAULIC CONSIDERATIONS

Pipe sizes shall be selected so that they hydraulic grade line shall, in general, be two (2) feet below the pavement or ground surface, and at no point less than one (1) foot.

The tidal elevation to be used in hydraulic computations, where applicable, shall be -2.5 feet City datum. The design high tide shall be -2.0 feet, City datum.

5.4 RUN-OFF

A. Rational Formula

Storm water run-off shall be computed by the Rational Formula, as herein described, or such other methods as may be determined by the Director to be City practice.

Rational Formula: $Q = CIA$, where

- Q = Quantity of Run-off in cubic feet per second.
- A = Drainage Area, tributary to the point under consideration, in acres.
- C = Coefficient of Run-off = Ratio of Run-off to Rainfall.
- I = Rate or Intensity of Rainfall in inches per hour
[= cubic feet per second (cfs) per Acre] for the duration of rainfall corresponding to time of concentration.

- B. Rainfall Intensity (I), or rate, used in design shall be taken from the tabulation entitled "San Francisco Rainfall Rate Table 1941," or subsequent revisions thereof, and is defined as a 5-year storm. The intensity, or rate, to be used at any point along the sewer line, shall be the intensity corresponding to the total time of concentration at that point.
- C. Area – The total area tributary to the point under consideration shall be used in design.
- D. Coefficient of Run-off (C) for any area depends upon the type of development, character of the soil, slope and general topography, and the proportion of the

**DRAFT Design Criteria and Standards
Sanitary and Storm Drain System
Hunters Point Shipyard**

area occupied by improvement. The coefficient used in design shall be in accordance with the values shown in Table I below and shall be subject to the approval of the SFPUC General Manager.

- E. Time of Concentration and Inlet Time – Time of concentration at any given points is the time required for the run-off from the most remote point in the drainage area to reach that point, and is equal to the inlet time plus the time of flow in the storm drain to the point under consideration.

Inlet time is the time required for the water from the most remote point of the drainage area to reach the uppermost inlet of the storm drain system. The inlet times used in design shall be 25 times.

F. **Surface Drainage**

- (i) On streets with flat grades, one or more intermediate low points along the gutter between intersections may be created. The curb height at these low points shall conform with City Standards. When this is not possible, any deviation from the standard curb height must be approved by the Director of Public Works.
- (ii) At low end cul-de-sac and sumps, in addition to sewer drainage facilities, surface drainage in facilities in dedicated easements, or surface drainage in streets, shall be provided as relief of overflow flooding of adjoining property.
- (iii) Street right-of-ways and drainage channel cross-sections shall be designed to provide a transport channel for overland or surface flow in excess of the 5-year storm capacity of the sewer system. The channel capacity shall be the difference between the sewer capacity and the quantity of runoff generated by a 100-year storm as defined by the U.S. Weather Bureau of by City-furnished data, applied over the tributary area involved.

**PART 6 - SEPARATED SANITARY SEWER FLOW CRITERIA IN THE CITY AND
COUNTY OF SAN FRANCISCO**

6.1 DESIGN BASIS

Sanitary or interceptor sewer shall be designed to carry the ultimate maximum sanitary flow.

6.2 MINIMUM SIZE

Sanitary main sewers shall be a minimum eight (8) inches in diameter unless otherwise permitted by the SFPUC General Manager.

**DRAFT Design Criteria and Standards
Sanitary and Storm Drain System
Hunters Point Shipyard**

6.3 VELOCITY

The grade of sanitary sewers shall be such as to produce a minimum velocity of two (2) feet per second under average sanitary flow conditions.

6.4 DEPTH

Sanitary sewers shall be constructed at the minimum depths of three (3) feet below ground.

6.5 SELECTION OF SEWER SIZES

In determining sewer sizes the coefficient of roughness "n" to be used shall be .013 for VCP and RCP.

6.6 QUANTITY OF FLOW

Where no water use records are available, the maximum ultimate sanitary flow to be used in design shall be computed on the basis of 180 gallons per day or 0.278 cubic feet per second per 1000 population. This maximum flow is predicated on an average ultimate flow of 100 gallons per capita per day. Where it is known that the average ultimate flow exceeds or will exceed 100 gallons per capita per day, the maximum ultimate flow used in design shall be adjusted accordingly.

Areas which include larger water users or industries which discharge large quantities of industrial wastes shall be given special consideration as to quantity and quality of sewerage.

6.7 POPULATION

In the absence of actual census counts, or other data, population densities for purposes of ultimate sanitary flow computations shall be assumed, subject to the approval of the SFPUC General Manager.

**DRAFT Design Criteria and Standards
Sanitary and Storm Drain System
Hunters Point Shipyard**

**TABLE 1
COEFFICIENT OF RUN-OFF AND INLET TIMES**

<u>Type of District</u>	<u>Range of Values Run-Off Coeff. "C"</u>	<u>Inlet Time in Minutes</u>	
		<u>Slope 3% & Over</u>	<u>Slope Under 3%</u>
Commercial	.80 to .96	3	5
Industrial	.60 to .90	3-5	4-6
Apts. & Flats	.60 to .80	3	5
Residential (Attached Homes)	.45 to .70	4	6
Residential (Detached Homes)	.40 to .65	5	7
Suburban	.25 to .35	6	10

F. SELECTION OF SEWER SIZES

Sewer sizes shall be computed by the Kutter, or the Manning, Formula. The values of the coefficient of roughness "n" to be used for different types of sewers shall be as indicated below in Table II but in no case less than 0.013.

**TABLE 2
COEFFICIENT OF ROUGHNESS "n"**

<u>Type of Sewer</u>	<u>Coefficient "n"</u>
Vitrified Clay Pipe	.013
Monolithic Concrete	.013
Centrifugally Cast Concrete Pipe	.013
Brick	.015
Corrugated Iron	.025

— End of Section —

**DRAFT Design Guidelines
Electrical System
Hunters Point Shipyard**

Foreword

This document is intended to serve as a guide in the preparation of design plans and specifications for the electrical power supply and distribution system at Hunters Point Shipyard (HPS). The recommendations set forth in this document are used only to indicate desirable procedures or methods and serve as guidelines for designers. It is the ultimate responsibility of the designer to develop a system that provides for:

- Personnel and public safety,
- Environmental impacts, including electric and magnetic fields, insulation, and clearances,
- Reliable service,
- Flexibility for the addition of future loads,
- Ease of maintenance,
- Convenience of operation,
- Interchangeability of equipment,
- Aesthetics, and
- Cost.

The basis for the design should be consistent with Pacific Gas and Electric's (PG&E's) design standards in accordance with PG&E Electric and Gas Service Requirements. The designer is responsible for using the most current PG&E design standards. The basic design responsibilities are outlined in the attached PG&E Design Selection form.

The design of the electrical systems and components will also be prepared in accordance with the laws and regulations of the federal government, State of California, and other industry standards. If there are conflicts between the cited documents, the more conservative requirement shall apply. The following codes and standards are applicable to the electrical aspects of the power facility.

- American National Standards Institute (ANSI)
- American Society for Testing and Materials (ASTM)
- California State General Order 95 (GO 95)
- California State General Order 128 (GO 128)
- Edison Electric Institute (EEI)
- Insulated Cable Engineers Association (ICEA)
- Institute of Electrical and Electronics Engineers (IEEE)
- Illuminating Engineering Society (IES)
- National Association of Corrosion Engineers (NACE)
- National Electrical Code (NEC)
- National Electrical Manufacturers Association (NEMA)
- National Electrical Safety Code (NESC)
- National Fire Protection Association (NFPA)
- Occupational Safety and Health Act (OSHA)
- Underwriters' Laboratories (UL)

**Pacific Gas & Electric Company
DESIGN SELECTION**

Project/Applicant Name: _____

Location: _____

City: _____ Tract No.: _____

GENERAL

The California Public Utilities Commission's Decision D. 97-12-099, dated July 1, 1998, permits you as a residential or a commercial applicant for gas and or electric extension(s) and service(s), to select either PG&E or your own contractor to design any necessary facilities.

A copy of PG&E's design standards will be provided at your expense. Your local PG&E representative is available to explain these options and any associated design and contract requirements for your project. Prior to the start of design, you must complete PG&E's Application for Service forms, provide applicable construction plans, and pay to PG&E an applicable project deposit, as determined by PG&E.

These two options are summarized as follows:

DESIGN BY PG&E

Under this selection, PG&E will provide and design its standard gas and or electric facilities for the extension in accordance with the standard provisions of its extension and service rules.

DESIGN BY APPLICANT

Under this selection, you or your contractor must design the trenching and installation of the gas and/or electric facilities within the PG&E specified project boundaries in accordance with the PG&E standards. This selection, according to the Commission's Decision D. 97-12-099, also requires the design(s) to be signed and stamped by a Registered Professional Engineer (PE). The general provisions of the requirements for gas and electric extension design by an applicant are summarized on page 2 of this form.

SELECTION

I hereby select the following: (please check the appropriate box and initial the line provided).

- Design by PG&E under the standard provisions of the rules.
Gas Extension _____ Electric Extension _____
- Design by Applicant.
Gas Extension _____ Electric Extension _____

By signing this form, you are notifying PG&E that: (1) your option selection is shown above; and (2) you understand your basic responsibilities as outlined on Page 2 of this document.

(Legal Name of Company)

(Mailing Address)

(Signature)

(Type/Print Name)

(Type/Print Name)

(Date)

APPLICANT'S DESIGN RESPONSIBILITIES

- Design drawings and provide support documentation
- Joint trench/pole intent drawings
- Gas layout drawings
- Single line drawings, key sketch
- Base maps
- Construction detail drawings
- Street light design - coordinate with applicable governmental agency
- Engineering calculations (e.g., voltage drop, flicker, pulling tension, pole sizing, guying, etc.)
- Substructure information
- Stub/full/branch service locations (pre-approved by utility)
- Main locations
- Meter locations (pre-approved by utility)
- Identify permits
- Identify rights-of-way as required by utility
- Trench cost allocation estimate
- Coordination with other utilities if joint trench or joint pole
- Tentative design and construction scheduling
- Gas handling procedures
- Leak test requirements
- Conflict checks
- Material list
- Stamped by a Registered Professional Engineer (PE)

Note: THE APPLICANT IS RESPONSIBLE FOR ENSURING THE DESIGNER USES THE MOST CURRENT DESIGN STANDARDS.

UTILITY'S DESIGN RESPONSIBILITIES

- Design format standards
- Global facilities planning (e.g. size, kind of pipe/conductor, carriers, conduits, ties, pressure/voltage/phase, system isolation requirements and special material specifications)
- Job accounting and cost estimating
- Contracts/Agreements.
- Utility plan check at completion of applicant design
- Post-design changes by utility at applicant's expense
- Value analysis

**AMENDMENT TO ATTACHMENT 10 (SCHEDULE OF PERFORMANCE FOR
INFRASTRUCTURE DEVELOPMENT AND OPEN SPACE "BUILD OUT" SCHEDULE OF
PERFORMANCE) TO THE DISPOSITION AND DEVELOPMENT AGREEMENT
HUNTERS POINT SHIPYARD
PHASE 1**

by and between

**THE REDEVELOPMENT AGENCY
OF THE CITY AND COUNTY OF SAN FRANCISCO**

and

**LENNAR-BVHP, LLC,
a California limited liability company
doing business as Lennar/BVHP Partners**

**AMENDMENT TO ATTACHMENT 10 (SCHEDULE OF PERFORMANCE FOR
INFRASTRUCTURE DEVELOPMENT AND OPEN SPACE "BUILD OUT" SCHEDULE OF
PERFORMANCE) TO THE DISPOSITION AND DEVELOPMENT AGREEMENT
HUNTERS POINT SHIPYARD
PHASE 1**

This Amendment to Attachment 10 (Schedule of Performance for Infrastructure Development and Open Space "Build Out" Schedule of Performance") to the Disposition and Development Agreement Hunters Point Shipyard Phase 1 (this "Amendment to Attachment 10 to the Phase 1 Horizontal DDA") dated as of August 5, 2008 is entered into by and between the Redevelopment Agency of the City and County of San Francisco, a public body, corporate and politic, exercising its functions and powers and organized and existing under the Community Redevelopment Law of the State of California (together with any successor public agency designated by or pursuant to law, the "Agency") and LENNAR-BVHP, LLC, a California limited liability company doing business as Lennar/BVHP Partners ("Developer").

RECITALS

This Amendment to Attachment 10 to the Phase 1 Horizontal DDA is made with reference to the following facts and circumstances:

A. The Agency and Developer entered into that certain Disposition and Development Agreement Hunters Point Shipyard Phase 1 dated as of December 2, 2003 and recorded April 5, 2005 as Document No. 2005H932190 at Reel I861, Image 564 in the Official Records of San Francisco County (the "Official Records"), as amended by that certain First Amendment to Disposition and Development Agreement Hunters Point Shipyard Phase 1 dated as of April 4, 2005 and recorded in the Official Records on April 5, 2005 as Document No. 2005H932191 at Reel I861, Image 565 (the "First Amendment"), and as further amended by that certain Second Amendment to Disposition and Development Agreement Hunters Point Shipyard Phase 1 dated as of October 17, 2006 and recorded in the Official Records on October 26, 2006 as Document No. 2006I275571 at Reel J254, Image 429 (the "Second Amendment") (collectively, the "Phase 1 Horizontal DDA"). The capitalized terms used

herein shall have the meaning set forth in the Phase 1 Horizontal DDA, unless otherwise specifically provided herein.

B. The First Amendment added the document at Exhibit I thereto [Open Space “Build Out” Schedule of Performance] as Attachment 31 to the Phase 1 Horizontal DDA. The First Amendment also deleted the list of Attachments to the Phase 1 Horizontal DDA and substituted it with Exhibit M thereto, an updated list of Attachments.

C. The Second Amendment deleted Attachment 10 [Schedule of Performance for Infrastructure Development] to the Phase 1 Horizontal DDA in its entirety and substituted it with the document at Exhibit C thereto [Schedule of Performance for Infrastructure Development and Open Space “Build Out” Schedule of Performance]. The Second Amendment inadvertently failed to delete Attachment 31 [Open Space “Build Out” Schedule of Performance] to the Phase 1 Horizontal DDA, which resulted in the inclusion of two Open Space “Build Out” Schedules of Performance within the Phase 1 Horizontal DDA.

D. The Agency and Developer wish to enter into this Amendment to Attachment 10 to the Phase 1 Horizontal DDA for the purposes of achieving redevelopment within Phase 1 of the Shipyard and making certain amendments to Attachment 10 of the Phase 1 Horizontal DDA to update the schedules of performance, all to further effectuate the program of development contemplated by the Redevelopment Plan. The Parties have entered into this Amendment to Attachment 10 to the Phase 1 Horizontal DDA to memorialize their understanding and commitments concerning the matters generally described above.

AGREEMENT

Accordingly, for good and valuable consideration, the amount and sufficiency of which is hereby acknowledged, Agency and Developer agree as follows:

1. Attachment 10 to the Phase 1 Horizontal DDA [Schedule of Performance for Infrastructure Development and Open Space “Build Out” Schedule of Performance] is hereby deleted in its entirety and the document at Exhibit A hereto is substituted in lieu thereof.
2. Attachment 31 to the Phase 1 Horizontal DDA [Open Space “Build Out” Schedule of Performance] is hereby deleted in its entirety and the document at Exhibit B hereto [Attachment 31 Intentionally Omitted] is substituted in lieu thereof.
3. The list of Attachments to the Phase 1 Horizontal DDA is hereby deleted in its entirety and the document at Exhibit C hereto is substituted in lieu thereof.
4. This Amendment to Attachment 10 to the Phase 1 Horizontal DDA constitutes a part of the Phase 1 Horizontal DDA and any reference to the Phase 1 Horizontal DDA shall be deemed to include a reference to such Phase 1 Horizontal DDA as amended hereby.
5. Except as otherwise amended hereby, all terms, covenants, conditions and provisions of the Phase 1 Horizontal DDA shall remain in full force and effect.
6. All capitalized terms used but not defined herein shall have the meanings assigned thereto in the Phase 1 Horizontal DDA.
7. This Amendment to Attachment 10 to the Phase 1 Horizontal DDA is binding upon and will inure to the benefit of the successors and assigns of the Agency and Developer, subject to the limitations set forth in the Phase 1 Horizontal DDA.
8. This Amendment to Attachment 10 to the Phase 1 Horizontal DDA may be executed in any number of counterparts, all of which, together, shall constitute the original agreement.

IN WITNESS WHEREOF, the Agency has caused this Amendment to Attachment 10 to the Phase 1 Horizontal DDA to be duly executed on its behalf and Developer has signed or caused this Amendment to Attachment 10 to the Phase 1 Horizontal DDA to be signed by duly authorized persons, all as of the day first above written.

Authorized by Agency Resolution No. 84-2008
adopted August 5, 2008
Approved as to Form:

By: 
for James B. Morales
Agency General Counsel

AGENCY:

REDEVELOPMENT AGENCY OF THE
CITY AND COUNTY OF SAN
FRANCISCO, a public body, corporate
and politic

By: 
Fred Blackwell
Executive Director

DEVELOPER:

LENNAR-BVHP, LLC, a California
limited liability company

By: Lennar Southland I, Inc., a
California limited liability
company, its managing member

By: 
Name: KOFI BONNER
Its: VICE - PRES.

EXHIBIT A

**Schedule of Performance for Infrastructure Development and
Open Space “Build Out” Schedule of Performance**

ATTACHMENT 10¹
SCHEDULE OF PERFORMANCE FOR INFRASTRUCTURE DEVELOPMENT

The following capitalized terms have the meanings set forth in this Section, wherever used in this Agreement.

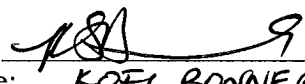
DEFERRED INFRASTRUCTURE ITEMS are composed of the following five items: (1) 2" asphalt concrete wearing surface, (2) plantings, (3) irrigation heads, (4) street furniture, and (5) driveways and sidewalks.

COMPLETE INFRASTRUCTURE CONSTRUCTION means Complete Construction of all items pertaining to Phase I work identified in the DDA, Attachment 9, and Infrastructure Plan with an exception for Deferred Infrastructure Items.

Activity	Schedule
Blocks 49, 50, 51	
Complete Infrastructure Construction	February 2009
Deferred Infrastructure Items	90 Calendar Days after substantial completion of vertical construction with respect to adjacency
Blocks 53, 54	
Complete Infrastructure Construction	March 2009
Deferred Infrastructure Items	90 Calendar Days after substantial completion of vertical construction with respect to adjacency
Blocks 1, 56, 57	
Complete Infrastructure Construction	May 2009
Deferred Infrastructure Items	90 Calendar Days after substantial completion of vertical construction with respect to adjacency
Blocks 52, 55E, 55W, Community Facilities Parcels along Galvez	
Complete Infrastructure Construction	June 2009
Deferred Infrastructure Items	90 Calendar Days after substantial completion of vertical construction with respect to adjacency
Block 48	
Complete Infrastructure Construction	August 2009
Deferred Infrastructure Items	90 Calendar Days after substantial completion of vertical construction with respect to adjacency



¹ This is current Schedule of Performance.

OPEN SPACE "BUILD OUT" SCHEDULE OF PERFORMANCE²

The following capitalized terms have the meanings set forth in this Section, wherever used in this Agreement.

COMPLETE OPEN SPACE CONSTRUCTION means Complete Construction of all open space component items contemplated in the Open Space and Streetscape Master Plan. At the time this Schedule of Performance for Infrastructure Development is amended, the Open Space Master Plan is at a conceptual level of detail and is required to be developed in accordance with the H-DRDAP. Items of work will be established when the final Construction Documents for the work are permitted.

Complete Open Space Construction	Schedule
Innes Court Park	8 months after Innes Avenue from Friedell Street to Coleman Street and all of Innes Court are completed.
a) Hillpoint Park, b) Hilltop ADA Path (from Galvez to Hudson) c) Hilltop Open Space, and d) Galvez Steps	8 months after Innes Avenue from Friedell Street to Coleman Street and all of Innes Court are completed.
Two Pocket Parks for Block 55E	24 months after first DBI building permit is obtained for vertical construction on Block 55E
Parcel G	24 months after first DBI building permit is obtained for vertical construction on Block 55E
Pocket Park for Blocks 50 and 49	24 months after first DBI building permit is obtained for vertical construction on either Block 50 or Block 49, whichever comes later.
Three Pocket Parks for Block 55W	24 months after first DBI building permit is obtained for vertical construction on Block 55W.
Three Pocket Parks Along Navy Road	24 months after first DBI building permit is obtained for vertical construction on any lots along Navy Road, adjacent to Lots 39 through 53; 54 through 69; 1 through 18, as appropriate.
5 Pocket Parks Along Oakdale	24 months after first DBI building permit is obtained for vertical construction on any lots along Oakdale, adjacent to Lots 70 through 83; 84 through 92; 93 through 109, 110 through 115; 116 through 131, as appropriate.
a) Central Park, b) Hillside ADA Paths, and c) Hillside Open Space	8 months after Oakdale Avenue and Navy Road are completed.
Interim African Marketplace	TBD in conjunction with SFRA.

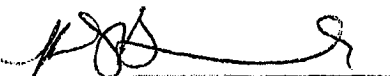

² This is current Schedule of Performance.

EXHIBIT B

Attachment 31 Intentionally Omitted

11/11/11

[Attachment 31 Intentionally Omitted]

EXHIBIT C

List of Attachments

ATTACHMENTS

1. Legal Description of Phase 1 and of the Project Site (which excludes the Agency Parcels)
2. Map of Project Site and of Agency Parcels, showing Agency Housing Parcels and Community Facilities Parcels

Schedule A – Map showing SLC Land, including Pre-Exchange SLC Land and Post-Exchange SLC Land

Schedule B – Land Use Plan

3. Quitclaim Deed from Agency to Developer
4. Short Term License Agreement (Agency Parcels)
5. Redevelopment Area Declaration of Restrictions
6. Reversionary Grant Deed
7. Insurance (includes environmental insurance)
8. Guaranty
9. Infrastructure Plan
 - Exhibit A Demolition and Deconstruction
 - Exhibit B Grading and Landslide Repair
 - Exhibit C Infrastructure Within the Rights of Way (including streets and utilities)
 - Exhibit D Public Open Space
10. Schedule of Performance for Infrastructure Development and Open Space “Build Out”
Schedule of Performance
11. EIR Mitigation Measures
12. Plan for Environmental Investigation and Remediation During Development at Hunters Point Shipyard
13. Prevailing Wage Requirements
14. Form of Card Check Requirements
15. Minimum Compensation Policy
16. Health Care Accountability Policy
17. Equal Benefits Policy
18. Form of Engineer’s/Architect’s Certificate Re Compliance of Design with Laws re Access

19. Form of Engineer's/Architect's Inspection Certificate

20. Form of Engineer's/Architect's Certificate Re Compliance of Construction with Laws re Access

21. Form of Certificate of Completion

22. Affordable Housing Program

Exhibit A Distribution of Affordable Housing Units

Exhibit B Declaration of Rental Use Restriction

Exhibit C Declaration of Restrictions for For-Rent Affordable Housing Units

Exhibit D Declaration of Restrictions for For-Sale Affordable Housing Units

Exhibit E Memorandum of Option

Exhibit F Release of Option Rights

Exhibit G Major Phase Housing Data Table

Exhibit H Project Housing Data Table

Exhibit I Marketing and Operating Obligations

23. Community Ownership, Financing and Benefits Policies and Procedures ^

24. Equal Opportunity Program and Additional Business, Employment, Construction Assistance/Opportunities and Community Benefits Program (including African Marketplace)

Exhibit A Equal Opportunity Program

Rider 1 Construction Work Force

Rider 2 Equal Opportunity for Women and Minority Owned Business Enterprises

Rider 3 Permanent Work Force of Developer and Retail Tenants

Rider 4 First Source Referral Hiring and Job Training

Exhibit B Additional Business, Employment, Construction

Assistance/Opportunities and Community Benefits Program (including African Marketplace)

25. Financing and Revenue Sharing Plan

Exhibit A Preliminary Budget and Project Pro Forma

Exhibit B Description of Qualified Predevelopment Costs

Exhibit C Description of Qualified Pre-Agreement Costs

26. Option: Alternative Financing and Revenue Sharing Plan with Accelerated Compensation for Land Value
27. Outline of Provisions of Vertical Disposition and Development Agreement
28. Transportation Management Plan
29. Interim Lease
30. Environmental Ordinances (Including Article 31)
31. [Intentionally Omitted]
32. Design Review and Document Approval Procedure for Infrastructure Development
33. Design Review and Document Approval Procedure for Vertical Improvements
34. Subdivision Map Ordinance and Regulations

ATTACHMENT 10

SCHEDULE OF PERFORMANCE FOR INFRASTRUCTURE DEVELOPMENT

Activity	Schedule
Parcel A-1	
Commence Construction	75 Calendar Days after Close of Escrow on A-1
Complete Construction on First Lot on A'	300 Calendar Days after Commencement of Construction
Complete Construction on Hilltop	450 Calendar Days after Commencement of Construction
Complete Construction on Hillside (Block 48)	720 Calendar Days after Commencement of Construction
Complete Construction on Block 1	810 Calendar Days after Commencement of Construction
Parcel B-1	
Commence Construction	75 Calendar Days after Close of Escrow on B-1
Complete Construction	360 Calendar Days after Commencement of Construction

ATTACHMENT 11

Hunters Point EIR Mitigation

MITIGATION MEASURES

1.

TRANSPORTATION, TRAFFIC AND CIRCULATION

1.A Transportation Demand Management

Adopt a Transportation Demand Management (TDM) approach by forming a Transportation management Association and preparing and adopting a Transportation System Management Plan which contains the elements specified in Measure 1.B.

1.A.1. Transportation Management Association

Form an HPS Transportation Management Association (TMA) composed of Agency staff; City agency staff from the Public Transportation Commission, Parking and Traffic Commission and the Department of Public Works; Hunters Point Shipyard owners, lessees and residents; and Bayview-Hunters Point community members to implement a Transportation System Management Plan (TSMP). The initial TMA group will be appointed by the Mayor for an 18-month term and will report to the Redevelopment Agency Commission ("Agency Commission"). As part of the development of the TSMP, the initial TMA will recommend procedures to the Agency Commission for future appointments to the TMA. The TMA will have no funding authority, but will develop a proposed TSMP for adoption by the Agency. The TSMP will identify funding needs, recommend potential funding sources and develop a phasing schedule consistent with the redevelopment phasing plan for implementation of identified measures. The TMA will monitor the effectiveness of the mitigation measures and the TSMP for the Agency. The TMA will provide an annual report to the Agency on the status of the TSMP implementation.

1.B Transportation System Management Plan

Have the TMA prepare and the Redevelopment Agency and affected City agencies adopt a TSMP. The TSMP shall identify program goals and implementing mechanisms for each of the following elements:

1.B.1. Transit Pass Sales

Establish a convenient location or locations within the boundaries of HPS for selling transit passes.

1.B.2. Transit, Pedestrian, and Bicycle Information

Provide maps of local pedestrian and bicycle routes, transit stops and routes, and other information, including bicycle commuter information, on signs and kiosks in occupied areas of HPS. Provide rideshare information and services through RIDES or an equivalent program.

1.B.3. Employee Transit Subsidies

Require major employers to use a transit subsidy system (e.g., through the Commuter Check Program) for their employees by incorporating transit subsidy requirements in the agreements between the Agency and developers. The TMA will identify major employers, recommend transit subsidy programs and identify transit subsidy systems that will provide employers with incentives to hire local employees as a way of reducing vehicle miles traveled.

1.B.4. Expand Transit Services and Monitor Transit Demand

Monitor transit demand at HPS on an annual basis and implement planned services as identified in the HPS Transportation Plan to stimulate transit ridership or respond to transit demand. The TMA will develop a phasing plan for implementation of transit improvements designed to meet or exceed demand. At a minimum, when HPS utilization includes 1,500 new employees or residents, implement those transit improvements contained in the Proposed Reuse Plan that are necessary to meet demand, including proposed MUNI extensions, if applicable. Continue to reevaluate transit demand and implement required improvements on an annual basis thereafter, and curtail commercial and residential development until required services are funded and implemented, if necessary, to prevent an imbalance between transit demand and services.

Identify incentives and disincentives to stimulate demand for transit and other alternative modes of transportation in place of the single occupancy automobile.

1.B.5. Secure Bicycle Parking

Require provisions for secured Class I bicycle parking spaces in parking lots and parking garages of residential buildings and research and development facilities. This secured bicycle parking is to be in amounts required by the San Francisco Planning Code, Article 1.5, Section 155. Require major employers and large employment sites occupied by many employees to provide clothing lockers and showers for bicyclists. Develop a program to make bicycles available to the public for travel within HPS.

1.B.6. Parking Management Guidelines

Establish mandatory parking management policies for the private operators of parking facilities in HPS to discourage long-term parking. Set aside desirable parking areas for rideshare vehicles and alternative fuel vehicles.

1.B.7. Flexible Work Time/Telecommuting

Where feasible, offer HPS employees the opportunity to work on flexible schedules and/or telecommute so they can avoid peak hour traffic conditions.

1.B.8. Shuttle Service

Require shuttle service to serve all redeveloped portions of HPS either through the provision of shuttle service by developers, large employers or another entity or entities. The shuttle service will operate between HPS and regional transit stops in San Francisco (e.g., MUNI, Third Street LRT, Bay Area

Rapid Transit (BART), CalTrain, Transbay transit terminal, and ferry terminal). Consider use of alternative fuel vehicles for the shuttle service.

1.B.9. Monitor Physical Transportation Improvements

Monitor physical transportation improvements, such as street repaving and resurfacing and installation of street lighting, and ensure that planned improvements are implemented when necessary to meet the needs of new residents and employees.

1.B.10. Ferry Service

Assist the Port of San Francisco and others in ongoing studies of the feasibility of expanding regional ferry service. Assist in implementing feasible study recommendations (if any) related to HPS service.

1.B.11. Local Hiring Practices

Require the TMA to set a goal to reduce traffic and air quality impacts by hiring workers who reside in the Bayview-Hunters Point neighborhood to fill new jobs at HPS. Qualified workers who reside in the Bayview-Hunters Point neighborhood should be given priority for new employment opportunities. Require compliance with existing Agency local hiring requirements and the City's "First Source" hiring program. Monitor local hiring on an annual basis to determine if the goal is being met and adjust the program as necessary.

1.B.12. Clean Air Program

Assist City's Clean Air Program in establishing natural gas fueling stations and electric charging bays in HPS and in implementing other means identified by the Clean Air Program for owners, tenants and users of HPS to use alternative fuel vehicles.

1.C Phelps/Evans

Eliminate the southbound left-turn lane and re-route turns via Phelps Street to Evans Street. Signalize the Phelps/Evans intersection and remove parking along Phelps and Evans Street. In addition, adopt a transportation system management approach as described under Mitigation Measure 1.B.

1.D Evans/Cesar Chavez

To improve operations and reduce delays at this intersection, restripe the existing northbound shared left/right-turn lane on Evans Avenue to create an exclusive left-turn lane and an exclusive right-turn lane. Widen the Evans Avenue northbound approach at Cesar Chavez Street. The southeast corner curb return will require structural modifications to the existing viaduct. Change the existing signal timing plan to include the exclusive left-turn and right-turn lanes.

1.E Adequate Transit Service

Monitor transit demand at HPS on an annual basis and ensure that adequate transit service is provided to meet or exceed demand, as required by the Transportation System Management approach described under Mitigation Measure 1.B.4.

1.F Pedestrian and Bicycle Facilities

Require completion of planned pedestrian and bicycle facilities as part of adjacent development. Monitor and ensure completion of these facilities as part of the TSMP described under Mitigation Measure 1.B.2.

2. AIR QUALITY

2.A TSMP Measures

Form a Hunters Point TMA and prepare a TSMP as described in Mitigation Measures 1.A and 1.B.

2.B Construction PM₁₀

BAAQMD officials consider PM₁₀ emissions from construction sites to be potentially significant. As conditions of construction contracts, contractors will be required to implement BAAQMD guidelines for controlling particulate emissions at construction sites. BAAQMD guidelines are summarized below:

- Seed and water all unpaved, inactive portions of the lot or lots under construction to maintain grass cover if they are to remain inactive for long periods during building construction.
- Halt all clearing, grading, earthmoving, and excavating activities during periods of sustained strong winds (hourly average wind speeds of 25 mph [40 km per hour] or greater).
- Water or treat all unpaved active portions of the construction site with dust control solutions, twice daily, to minimize windblown dust and dust generated by vehicle traffic. (City Ordinance 175-95 requires that nonpotable water be used for this purpose.)
- Sweep paved portions of the construction site daily or as necessary to control windblown dust and dust generated by vehicle traffic. Sweep streets adjacent to the construction site as necessary to remove accumulated dust and soil.
- Cover trucks carrying loose soil or sand before they leave the construction site, and limit on-site vehicle speeds to 15 mph (24 km per hour) or lower in unpaved construction areas.
- Limit the area subject to excavation, grading or other construction activity at any one time. Cover on-site storage piles of loose soil or sand.

2.C Toxic Air Contaminants

SFRA will evaluate and permit all potential stationary sources of toxic air contaminants allowed at HPS as one facility and allow new potential stationary sources only if the estimated incremental toxic air contaminant health risk from all stationary sources at HPS is consistent with BAAQMD significance criteria for an industrial facility.

3.
NOISE

3.A Residential Construction

To reduce noise impacts to proposed residential properties east of Donahue Street, orient and design new or renovated buildings such that future noise intrusion will be minimized to within acceptable levels. In addition, comply with the San Francisco Building Code's noise insulation standards for new residential construction. Physical barriers also could be constructed to reduce noise transmission to these residential areas.

7.
HAZARDOUS MATERIALS AND WASTE

7.A Reuse Prior to Complete Remediation

Implement basewide restrictions on and notifications for leased areas prior to remediation (related to IR sites and areas of concern), as described below.

- Prohibit users from disturbing soil or conducting intrusive activities without prior Navy approval and coordination with Federal and state regulatory agencies. Prohibitions could include, but are not limited to, shoveling, digging, trenching, installing wells, and conducting subsurface excavations.
- Prohibit users from entering fenced-off areas, areas where environmental investigations are in progress, or areas where access is not authorized, as indicated by appropriate signs.
- Restrict access to fenced areas of Parcel E until remediation activities have been completed.
- Maintain intact the current condition of all flooring and interior and exterior pavement and concrete in lease area.
- Prohibit the use of groundwater at HPS for any purpose.
- Notify users that petroleum hydrocarbons and hazardous substances have been detected in the soil and groundwater at HPS.
- Notify users that investigations and remediation are ongoing at IR sites at HPS. Lessee must not interfere with ongoing environmental investigation and remediation efforts. Areas where sampling and remediation crews are working must be avoided.
- Prohibit access to waterfront areas for fishing until it is determined by EPA through the CERCLA process that Parcel F is remediated to a condition protective of human health and ecological resources.

7.B Construction Prior to Remediation

The following precautionary measures will be implemented by the project proponent during necessary construction activities prior to remediation. These measures are general and will be refined based on site-specific information and consultation with regulatory agencies.

- Obtain site-specific information about soil or groundwater that would be disturbed through new testing or existing information from the Navy and consultation with regulatory agencies.
- Before disturbing soil or groundwater, or conducting intrusive activities such as shoveling, digging, trenching, installing wells, subsurface excavations, or building renovation, obtain Navy approval and coordinate with Federal and state regulatory agencies. This coordination would result in an identification of precautionary measures to be implemented during construction activities. The precautionary measures would be incorporated into a site-specific Health and Safety Plan (HASP) (see Section 3.7.5) that is consistent with the contaminants present.
- Implement dust suppression measures to limit airborne contaminants in accordance with BAAQMD requirements.
- Handle and dispose of soil in a manner consistent with the contamination present, as required by Federal, state, and local laws and regulations.

7.C Reuse After Complete Remediation

Implement and monitor compliance with institutional controls designed to be protective of public health, as determined by law and in consultation with the regulatory agencies. These institutional controls would likely include a prohibition on the use of groundwater and on residential uses in non-residential areas, notification regarding residual contamination, and encapsulation methods.

7.D Construction After Remediation

Perform construction activities in a manner consistent with institutional controls designed to be protective of public health, as determined in consultation with the regulatory agencies; and in accordance with CAL OSHA regulations. Take the following additional steps, where warranted by site-specific information:

- Obtain information on soil and groundwater contamination by sampling, reviewing existing Navy data, and/or consulting with regulatory agencies. When no sampling results are available, develop and implement a sampling program similar to that required under Article 22A of the San Francisco Public Works Code.
- If contamination is identified in the areas proposed for disturbance, prepare a site mitigation plan, similar to that required under Article 22A of the Health Code. If applicable, implement the requirements of Cal. Code Reg. Tit. 8 § 5192 (Hazardous Waste Operations and Emergency Response).
- Dispose of groundwater in accordance with applicable permits.

7.E Construction Contingency Plan for Unanticipated Hazardous Materials

Inform contractors that unknown hazardous materials could be encountered during demolition or excavation, and instruct them regarding steps to be taken if this occurs. These steps include the following:

- The contractor shall immediately stop work in the area and notify the San Francisco Department of Public Health (DPH) verbally and in writing.
- The contractor shall immediately secure the area to prevent accidental access by construction workers or the public.
- The identified material shall be sampled as directed by DPH.
- Handling and disposal of identified materials shall be in accordance with DPH direction and in compliance with applicable laws and regulations.
- Work on site may resume only where and when permitted by DPH.

7.F Controls on Ecological Exposure to Hazardous Materials During Construction

For surface water impacts, follow all conditions of the state of California storm water construction permit, including implementing BMPs to reduce storm water runoff from the site.

For groundwater discharge impacts, follow all permit requirements for discharge into the storm water system or sanitary sewer system. Treat water as appropriate to comply with discharge levels as required by the permit.

Assess potential effects on groundwater gradients within construction areas if dewatering is proposed or if new utility lines are proposed that could act as conduits for contaminants in groundwater. Conduct dewatering activities and design utility installations such that contamination does not spread to the Bay or other ecologically sensitive areas. New storm drains shall have watertight joints, such as rubber gaskets. Methods to be considered could include installing sheet piling; groundwater pumping/recharge, and installing utility lines in impermeable bedding material.

For boring and pile driving activities along the Bay, drive the piles directly into the sediments without boring where possible, to minimize and localize sediment disruption. Where pile driving without drilling is not possible due to shallow bedrock, drive a casing to the solid material, preventing collapse of the material and allowing drilling to occur within the casing without excessive sediment disruption. Then place the pile in the casing and backfill with concrete.

Perform dredging activities in a manner consistent with institutional controls established via the CERCLA process. Require consultation with agencies represented in the Army Corps of Engineers Interagency Dredged Material Management Office regarding appropriate methods for limiting disturbance of sediment, containing suspended sediment to the immediate area being dredged, and additional measures to be protective of human health and the environment as described in Section 3.7.5 (under Dredging).

7.G Controls on Cross Contamination of Aquifers During Construction

Place piles in a manner so that there is no conduit for groundwater migration along pile edges. Where possible, drive piles directly into sediments without drilling. If drilling is required, drive casing into bedrock, drill within casing, and backfill with cement grout.

8.
GEOLOGY AND SOILS

8.A Handling Naturally Occurring Asbestos During Construction

Follow BAAQMD, U.S. EPA, and federal and CAL OSHA regulations for construction and demolition activities. Continuously wet serpentinite involved in excavation or drilling operations. Wet and cover stockpiled serpentinite. Do not use serpentinite as road, surfacing, or paving material. Cap serpentinite used as fill material with at least one foot (0.3 m) of clean non-serpentinite fill material, and implement institutional controls to prevent future exposure from excavation activities. Treat excavated waste materials containing greater than one percent asbestos by weight as hazardous waste, and transport and dispose of this material in accordance with applicable Federal and state regulations.

8.B Existing Building Survey for Seismic Hazards

Before increasing the occupancy of existing buildings, survey buildings that may be unsafe in the event of an earthquake, and take appropriate steps to prevent injury. Those steps could include interior modifications, bracing, retrofits, and/or access restrictions.

9.
WATER RESOURCES

9.A Storm Water Improvement Design to Control CSO Volumes

Eliminate projected increases in combined sewer overflow (CSO) volumes caused by storm water discharges to the City's combined system by upgrading or replacing the separated system at HPS (Option 1 or 2). Also consider ways to offset non-significant increases attributable to sanitary flows. Arrange for the SFPUC to condition permits issued for groundwater discharge to the City's combined sewer system, so that discharges do not occur in wet weather when overflows are anticipated to occur.

9.B Storm Water Discharge Quality

To ensure that the quality of storm water discharges improves as anticipated, implement the following measures:

- Develop and implement a SWPPP for HPS that is applicable to new development under the Redevelopment Plan to control the quality of direct discharges of stormwater to near-shore waters. The SWPPP will include provisions for controlling soil migration off site (e.g., silt fences, settling units) during periods of runoff and for monitoring possible sources of industrial contaminants. Develop the program in coordination with the San Francisco Public Utility Commission staff and according to guidelines contained in the California Municipal Storm Water Best Management Practice Handbook, the California Industrial/Commercial Storm Water Best Management Practice Handbook and U.S. EPA's proposed Phase II stormwater regulations.
- As part of the SWPPP, implement BMPs such as public education and outreach, pollution prevention, and good housekeeping.

- Construct stormwater retention and treatment areas on site to improve the quality of discharges to the Bay. Specify in the SWPPP the locations of appropriate areas for stormwater infiltration that avoid toxic hot spot areas and capped areas and identify drainage patterns to direct stormwater to appropriate infiltration locations.

10. **UTILITIES**

10.A Drinking Water Distribution System

Prior to authorization of reuse activities within a given area of HPS, assess deficiencies in the water distribution system and address them through planned infrastructure improvements or other actions.

As proposed under the draft utility infrastructure plan, replace the potable water distribution system with a new system built to meet demands of proposed development. This will ensure the supply of safe potable water and adequate water pressure. As an alternative to wholesale system replacement, the City also could implement incremental improvements.

- In the upper housing area, cap the water distribution system and drain and abandon the 410,000-gallon (1.5-million liter) tank.
- Locate, excavate, and repair valves and lines. Replace PVC lines.
- Sample water at the point of consumption for chlorine, lead, and copper levels to ensure that it complies with the Safe Drinking Water Act.
- Install backflow preventors at the two San Francisco service points.
- Inspect service points for cross connections and for exposure to contamination so problems can be remediated, if needed.
- Install water meters to measure quantities delivered.

10.B Fire Fighting Water Distribution System

Prior to authorization of reuse activities within a given area of HPS, assess fire fighting deficiencies in the water systems and address them through planned infrastructure improvements or other actions. Construct a new auxiliary water supply system to augment the water supply for fire fighting purposes. As an alternative to constructing a new system, the City may, in the interim, upgrade the existing potable water distribution system and fire hydrants to meet fire-fighting needs.

10.C Storm Water Collection System

Prior to authorization of reuse activities within a given area of HPS, assess deficiencies in the storm water collection system and address them through planned infrastructure improvements or other actions.

To mitigate impacts, implement the following measures:

- Upgrade or replace the storm water collection system as planned in each section of HPS prior to reuse.
- Restrict the amount of paved surfaces at HPS for no net increase
- Design the storm water collection system to incorporate appropriate infiltration locations and drainage patterns contained in the SWIPPP as provided in Measure 9.B.
- Install valves, gates, or duckbills at storm line discharge points to prevent tidal surges and movement of contaminated Bay Mud into the storm lines.

10.D Sanitary Collection System

Prior to authorizing reuse activities within a given area of HPS, assess deficiencies in the sanitary collection system and address them through planned infrastructure improvements or other actions. Construct a sanitary collection system at HPS to meet the Proposed Reuse Plan's sanitary collection needs.

10.E Natural Gas System

Prior to authorization of reuse activities within a given area of HPS, assess deficiencies in the natural gas system and address them through planned infrastructure improvements or other actions. Construct a natural gas system according to Federal, state, and local codes to meet the Proposed Reuse Plan's needs.

12 **CULTURAL RESOURCES**

12. A Protection of Historical Resources

Implement applicable measures to be contained in an MOA between the Navy and SHPO, with City/Agency concurrence. Measures to include:

- Agreement by the City/Agency to designate NRHP-eligible buildings and structures as landmarks under San Francisco's own historic preservation ordinance or to prohibit demolishing these resources.
- Agreement by the City/Agency to require the use of the Secretary of the Interior's *Standards for Rehabilitation and Guidelines for Rehabilitating Historic Buildings* for all alterations proposed to historic resources identified as eligible for listing in the NRHP.
- Agreement by the City/Agency to inform future project developers of the potential for encountering archeological resources and the required procedures to be followed (see Mitigation 12.D below).

12. B Alteration of Historical Resources

Comply with the Proposed Reuse Plan, *Hunters Point Shipyard Redevelopment Plan*, and associated *Design for Development*, including requirements for retaining and identifying the historical resources described in Section 3.12. These documents also require that alterations that affect the historic resources be implemented according to the Secretary of the Interior's *Standards for Rehabilitation and Guidelines for Rehabilitating Historic Buildings* (Proposed Reuse Plan Objective 12, Policy 6).

12. C Construction Within Historic District

Any construction within the Hunters Point Commercial Drydock Historic District will require compliance with the policies set forth in the Proposed Reuse Plan, which calls for creating an attractive and distinctive visual character for HPS that respects and enhances the natural features, the history, and the vision for mixed-use development oriented toward arts and industrial uses (Objective 11). It further states that the structures around Drydocks 2 and 3 will be the focus of the arts/cultural and mixed-use district (Objective 12, Policy 2). Construction must also comply with applicable provisions of the Secretary of the Interior's *Standards for Rehabilitation and Guidelines for Rehabilitating Historic Buildings*.

12. D Archeological Resources

Require contractors to be made aware of the potentials for discovery of archaeological resources. If development in the four subsurface zones identified as having the potential for containing significant archeological deposits involves construction or installation below the level of fill, retain a professional archeologist to develop a project-specific treatment or monitoring program. If archaeological resources are discovered during construction, suspend all work in the immediate vicinity. Avoid altering the materials and their context pending site investigation by a qualified professional archeologist. If the qualified professional archeologist determines that the discovery is significant, notify the SHPO and ensure that an appropriate treatment plan is developed and implemented.

13

BIOLOGICAL RESOURCES

13.A Wetlands Habitat Protection

Place barriers along the Bay side of trails to reduce human and domestic animal disturbances to sensitive wetland habitats. Design barriers so that wildlife cannot hear or see people from foraging areas and so that people cannot easily leave the trail to enter sensitive wildlife areas. Develop and implement a public access program to include fencing sensitive areas, posting signs, and imposing leash requirements to further reduce disturbance to wetland areas.

13. B Litter Control

Provide adequate trash receptacles along public access areas. Ensure pick-up and trash receptacle maintenance on a regular basis.

ATTACHMENT 12

Plan for Environmental Investigation and Remediation During Development at Hunters Point Shipyard

Purpose

Redevelopment activities on Parcels A' and B' are or will be subject to mitigation measures set forth in the Environmental Impact Report, deed notices, restrictions or other environmental covenants (collectively, "deed restrictions"), and state, local and federal requirements addressing contamination, human health and safety and the environment. This document describes the understanding and agreement between the San Francisco Redevelopment Agency (SFRA) and Lennar/BVHP that redevelopment activities at Hunters Point Shipyard (HPS) which include disturbance of soil and/or groundwater must be conducted in compliance with all applicable mitigation measures, deed restrictions and any state, local and federal requirements and outlines the process for ensuring that environmental investigation and soil and groundwater management during redevelopment of Parcels A' and B' are conducted in compliance with these requirements.

The parties anticipate that the City and County of San Francisco and its departments (City) will, prior to the closing for each transfer of property, enact an ordinance or other legislation and necessary implementing regulations to facilitate implementation and enforcement of these requirements for the transferring property (all action by the Board of Supervisors and Mayor and all rule-making and formal directives by any City department is collectively referred to herein as "legislative action" or "legislation"). Lennar/BVHP must comply with the legislation prior to undertaking any disturbance of soil or groundwater or similar activities.

The parties agree that the requirements imposed by the mitigation measures, deed restrictions and state, local and federal requirements apply regardless of whether the City takes legislative action. Accordingly, if the City fails to enact legislation prior to closing, Lennar/BVHP agrees to enter into an agreement with SFRA, including the terms described below, to implement these requirements.

Background

Past Navy operations at HPS resulted in contamination subject to regulation and cleanup under the Comprehensive Environmental Response, Compensation and Liability Act (CERCLA) process, Toxic Substances Control Act (TSCA) (for polychlorinated biphenyl (PCB) sites), the California Porter-Cologne Water Quality Control Act (for petroleum constituents) and other similar federal and state laws. Because some residual contamination may remain after transfer, special requirements apply to soil and groundwater disturbance and management activities as set forth in the mitigation measures and deed restrictions. In addition to these special requirements, state, local and federal law impose requirements on activities involving discovery, disturbance and cleanup of contamination and protection of human health and safety and the environment.

Implementation

City Legislative Action

In order to facilitate compliance with these requirements, staff for the City have proposed that the City enact legislation for each parcel that would establish a program to describe and integrate the special requirements with other existing City requirements. The legislation would be modeled on existing City ordinances, such as the "Maher Ordinance" (Health Code Article 22A). Among other things, the legislation would: (i) set forth a process for preparing and submitting a site history and soil analysis report for approval by the City and taking other action as directed as a prerequisite to obtaining building or grading permits (described in detail below); (ii) require reimbursement of administrative costs; (iii) authorize City departments to adopt implementing regulations and take other actions consistent with the legislation; and (iv) establish an enforcement scheme, including penalties, for violations. Where deed restrictions apply, legislation or implementing regulations may take the form of a standard Soil and Groundwater Management Plan (SGWMP) or a series of such plans that would describe and mandate specific soil and groundwater management procedures for development activities. A standard or site-specific SGWMP may be separately subject to approval by state and federal agencies (including the Navy) that have jurisdiction over deed restrictions.

All legislative action will be governed by the Brown Act and the City's Sunshine Ordinance.

The basic elements of the procedures that would be embodied in the City's proposed legislation are described below.

(1) Consistent with mitigation measures, special requirements will apply when required by institutional controls imposed by regulatory agencies or where warranted by site-specific information. Special requirements will apply to activities that would result in the disturbance of soil and/or groundwater at the site. Redevelopment activities involving soil disturbance include, without limitation, demolition/deconstruction, utility installation and maintenance, grading, trenching, pile driving, drilling, soil removal, construction of subsurface structures. Groundwater-related activities include dewatering. Consistent with the scope of the "Maher Ordinance" and mitigation measures, certain requirements may not apply to areas that have been used continuously for residential purposes, are not located in historic fill areas and where there is no evidence based on previous information or investigations that the soil may contain hazardous substances.

(2) For persons undertaking these activities, proof of compliance with the procedures will be a prerequisite of the issuance of various building permits issued by the City, including:

- Building, Grading or Demolition Permit
- Well Permits
- Underground Storage Tank Permit
- Encroachment Permits
- Sidewalk and Street Use Permits.

(3) To demonstrate compliance, applicants for permits will be required to:

- Prepare a summary of historical information and describe any prior site characterization and remediation performed by the Navy;
- Perform any additional site characterization (soil sampling and analysis) necessary to manage soil and groundwater in accordance with requirements;
- Prepare a project environmental management plan for permit application submittal and City approval. The plan would provide details of the development activities and how the soil and/or groundwater will be managed and would include items such as: scope and extent of excavation or grading; schedule; specific protocols for managing soil and groundwater; field sampling and laboratory analysis plan; transportation plan identifying routes of travel and final destination of wastes; contingency procedures for unanticipated conditions; site-specific health and safety plan; and site mitigation plan, if necessary;
- Obtain City approval and any other required permits or environmental notifications.
- Submit summary closeout report that includes any additional site characterization information, unanticipated conditions, and scope changes.

(4) Soil Reuse/Disposal and Groundwater Management. All excavated soil that is intended to be reused on-site will need to be evaluated to determine if additional characterization is necessary. The legislation will set forth protocols for soil reuse. For example, if there is adequate existing data (or supplemental data), and that data indicates that there is no contamination, the excavated soil may be reused on-site in compliance with the required protocols. Soil that does not meet soil reuse criteria will be disposed of at an appropriate facility. All excavated soil that is intended to be disposed off-site will be evaluated and characterized to the extent necessary to comply with applicable laws governing solid and hazardous waste management and worker protection.

All encountered groundwater will be considered potentially contaminated. Discharge to the ground surface or storm drain is prohibited without City approval. Groundwater encountered in excavations must be extracted to the extent necessary to perform the work and containerized (in tanks or drums) for chemical analysis prior to discharge. Depending on the analytical results, contaminated water will be discharged to either the sanitary sewer or an approved off-site facility for treatment and disposal in compliance with law.

Alternative to City Legislative Action

The City's failure to take legislative action does not relieve Lennar/BVHP or any other party from compliance with the requirements imposed by the mitigation measures, any applicable deed restrictions or state, local or federal requirements. If the City fails to enact legislation prior to closing, Lennar/BVHP will enter into an agreement with SFRA and/or the City prior to closing to ensure compliance with these requirements and the procedural and substantive requirements outlined above. Such agreement will include, without limitation, the following terms and other mutually agreeable terms:

(1) Lennar/BHVP will develop a written program and necessary protocols, subject to approval by the SFRA and the City, which will describe how each requirement of the mitigation measures, applicable deed restrictions and state, local and federal requirements will be met; how human health and safety will be protected during and after development; and a reporting protocol. The program shall incorporate compliance with existing local, state and federal laws, including those governing permitting and cleanup.

(2) Lennar/BHVP will comply with the approved program and protocols as a prerequisite to obtaining various necessary permits, such as those listed above.

(3) Lennar/BHVP will reimburse SFRA for all administrative costs, including without limitation, costs of reviewing and approving the program and reports, and acting as liaison to City departments with jurisdiction.

(4) Lennar/BHVP will reimburse City for all administrative costs.

(5) Lennar/BHVP will obtain whatever approvals or waivers are required to comply with deed restrictions, including seeking approvals or waivers from state and/or federal regulators (including the Navy).

(6) Lennar/BVHP will acknowledge that its failure to comply with these requirements may result in the non-issuance, revocation or enforcement of permits by the City.

ATTACHMENT 13

PREVAILING WAGE REQUIREMENTS (LABOR STANDARDS)

These Prevailing Wage Requirements (hereinafter referred to as "Labor Standards") are attached to and made a part of the Disposition and Development Agreement (the "Agreement") for Hunters Point, Phase 1 ("Phase 1"). The Developer is bound by this Attachment as part of the obligations it assumes, and benefits it receives, under the Agreement.

Section 1. Applicability. These Labor Standards apply to any and all construction of the Horizontal [Vertical] Improvements as defined in the Agreement.

Section 2. All Contracts and Subcontracts shall contain the Labor Standards; Confirmation by Construction Lender. All specifications relating to the construction of the Horizontal [Vertical] Improvements shall contain these Labor Standards and the Developer shall have the responsibility to assure that all contracts and subcontracts, regardless of tier, incorporate by reference the specifications containing these Labor Standards. If for any reason said Labor Standards are not included, the Labor Standards shall nevertheless apply. The Developer shall supply the Agency with true copies of each contract relating to the construction of the Horizontal [Vertical] Improvements showing the specifications that contain these Labor Standards promptly after due and complete execution thereof and before any work under such contract commences. Failure to do so shall be a violation of these Labor Standards.

Section 3. Definitions.

Terms not defined in this Attachment have the meanings given to them in the Agreement.

Agency's Optional Form has the meaning set forth in Section 8.2(a).

BAT has the meaning set forth in Section 6.

Bona Fide Prepayment of Wages has the meaning set forth in Section 5.2.

Contractor is the Developer if permitted by law to act as a contractor, the general contractor, and any contractor as well as any subcontractor of any tier having a contract or subcontract that exceeds \$10,000.00, and who employs Laborers, Mechanics, Working Foremen, and security guards to perform the construction on all or any part of the Horizontal [Vertical] Improvements.

DAT has the meaning set forth in Section 6.

Laborers and Mechanics are all persons providing labor to perform the construction, including Working Foremen and security guards.

Non-Complying Contractor has the meaning set forth in Section 13.2.

Non-Conforming Contract has the meaning set forth in Section 13.2.

Notice of Dispute has the meaning set forth in Section 13.3.

Notice to Employees has the meaning set forth in Section 12.

Statement of Compliance has the meaning set forth in Section 8.2(b).

Wage Determination has the meaning set forth in Section 4.1.

Working Foreman is a person who, in addition to performing supervisory duties, performs the work of a Laborer or Mechanic during at least twenty percent (20%) of the work week.

Section 4. Prevailing Wage.

4.1 All Laborers and Mechanics employed in the construction of the Horizontal [Vertical] Improvements will be paid unconditionally and not less often than once a week, and without subsequent deduction or rebate on any account (except such payroll deductions as are permitted by Section 5) the full amount of wages and bona fide fringe benefits (or cash equivalents thereof) due at the time of payment, computed at rates not less than those contained in the General Prevailing Wage Determination ("Wage Determination") made by the Director of Industrial Relations pursuant to California Labor Code Part 7, Chapter 1, Article 2, §§ 1770, 1773 and 1773.1, regardless of any contractual relationship which may be alleged to exist between the Contractor and such Laborers and Mechanics. A copy of the applicable Wage Determination is on file in the offices of the Agency with the Development Services Manager. At the time of Close of Escrow, the Agency shall provide the Developer with a copy of the applicable Wage Determination.

All Laborers and Mechanics shall be paid the appropriate wage rate and fringe benefits for the classification of work actually performed, without regard to skill. Laborers or Mechanics performing work in more than one classification may be compensated at the rate specified for each classification for the time actually worked therein, provided that the Contractor's payroll records accurately set forth the time spent in each classification in which work is performed.

4.2 Whenever the wage rate prescribed in the Wage Determination for a class of Laborers or Mechanics includes a fringe benefit which is not expressed as an hourly rate, the Contractor shall either pay the benefit in the manner as stated therein, *i.e.*, the vacation plan, the health benefit program, the pension plan and the apprenticeship program, or shall pay an hourly cash equivalent thereof.

4.3 If the Contractor does not make payments to a trustee or other third person, the Contractor may consider as part of the wages of any Laborer or Mechanic the amount of any costs reasonably anticipated in providing benefits under a plan or program of a type expressly listed in the Wage Determination, provided that the Executive Director of the Agency has found, upon the written request of the Contractor, made through the Developer, that the intent of the Labor Standards has been met. Records of such costs shall be maintained in the manner set forth in Section 8.1. The Executive Director of the Agency may require the Developer to set aside in a separate interest-bearing account with a member of the Federal Deposit Insurance Corporation,

assets to meet obligations under the plan or program referred to above in Section 4.2. The interest shall accumulate and shall be paid as determined by the Agency acting at its sole discretion.

4.4 Regular contributions made or costs incurred for more than a weekly period (but not less often than quarterly) under plans, funds, or programs, which cover the particular weekly period, are deemed to be constructively made or incurred during such weekly period.

Section 5. Permissible Payroll Deductions. The following payroll deductions are permissible deductions. Any others require the approval of the Agency's Executive Director.

5.1 Any withholding made in compliance with the requirements of federal, state or local income tax laws, and the federal social security tax.

5.2 Any repayment of sums previously advanced to the employee as a bona fide prepayment of wages when such prepayment is made without discount or interest ("Bona Fide Prepayment of Wages"). A Bona Fide Prepayment of Wages is considered to have been made only when cash or its equivalent has been advanced to the employee in such manner as to give him or her complete freedom of disposition of the advanced funds.

5.3 Any garnishment, unless it is in favor of the Contractor (or any affiliated person or entity), or when collusion or collaboration exists.

5.4 Any contribution on behalf of the employee, to funds established by the Contractor, representatives of employees or both, for the purpose of providing from principal, income or both, medical or hospital care, pensions or annuities on retirement, death benefits, compensation for injuries, illness, accidents, sickness or disability, or for insurance to provide any of the foregoing, or unemployment benefits, vacation pay, savings accounts or similar payments for the benefit of employees, their families and dependents, provided, however, that the following standards are met:

(a) The deduction is not otherwise prohibited by law; and

(b) It is either:

(1) Voluntarily consented to by the employee in writing and in advance of the period in which the work is to be done and such consent is not a condition either for obtaining or for the continuation of employment, or

(2) Provided for in a bona fide collective bargaining agreement between the Contractor and representatives of its employees; and

(3) No profit or other benefit is otherwise obtained, directly or indirectly, by the Contractor (or any affiliated person or entity) in the form of commission, dividend or otherwise; and

(4) The deduction shall serve the convenience and interest of the employee.

5.5 Any authorized purchase of United States Savings Bonds for the employee.

5.6 Any voluntarily authorized repayment of loans from or the purchase of shares in credit unions organized and operated in accordance with federal and state credit union statutes.

5.7 Any contribution voluntarily authorized by the employee for the American Red Cross, United Way and similar charitable organizations.

5.8 Any payment of regular union initiation fees and membership dues, but not including fines or special assessments, provided that a collective bargaining agreement between the Contractor and representatives of its employees provides for such payment and the deductions are not otherwise prohibited by law.

Section 6. Apprentices and Trainees. Apprentices and trainees will be permitted to work at less than the Mechanic's rate for the work they perform when they are employed pursuant to and are individually registered in an apprenticeship or trainee program approved by the U.S. Department of Labor, Employment and Training Administration, Bureau of Apprenticeship and Training ("BAT") or with the California Department of Industrial Relations, Division of Apprenticeship Standards ("DAS") or if a person is employed in his or her first ninety (90) days of probationary employment as an apprentice or trainee in such a program, who is not individually registered in the program, but who has been certified by BAT or DAS to be eligible for probationary employment. Any employee listed on a payroll at an apprentice or trainee wage rate, who is not registered or otherwise employed as stated above, shall be paid not less than the applicable wage rate for a Mechanic. Every apprentice or trainee must be paid at not less than the rate specified in the registered program for the employee's level of progress, expressed as a percentage of a Mechanic's hourly rate as specified in the Wage Determination. Apprentices or trainees shall be paid fringe benefits in accordance with the provisions of the respective program. If the program does not specify fringe benefits, employees must be paid the full amount of fringe benefits listed in the Wage Determination.

Section 7. Overtime. No Contractor contracting for any part of the construction of the Horizontal [Vertical] Improvements which may require or involve the employment of Laborers or Mechanics shall require or permit any such Laborer or Mechanic in any workweek in which he or she is employed on such construction to work in excess of eight (8) hours in any calendar day or in excess of forty (40) hours in such workweek unless such Laborer or Mechanic receives compensation at a rate not less than one and one-half (1.5) times the basic rate of pay for all hours worked in excess of eight (8) hours in any calendar day or in excess of forty (40) hours in such workweek, whichever is greater.

Section 8. Payrolls and Basic Records.

8.1 Payrolls and basic records relating thereto shall be maintained by the Contractor during the course of its construction of the Horizontal [Vertical] Improvements and preserved for a period of one (1) year thereafter for all Laborers and Mechanics it employed in the construction of the Horizontal [Vertical] Improvements. Such records shall contain the name, address and social security number of each employee, his or her correct classification, hourly rates of wages paid (including rates of contributions or costs anticipated for fringe benefits or cash equivalents

thereof), daily and weekly number of hours worked, deductions made and actual wages paid. Whenever the wages of any Laborer or Mechanic include the amount of any costs reasonably anticipated in providing benefits under a plan or program, the Contractor shall maintain records which show the costs anticipated or the actual costs incurred in providing such benefits and that the plan or program has been communicated in writing to the Laborers or Mechanics affected. Contractors employing apprentices or trainees under approved programs shall maintain written evidence of the registration of apprenticeship programs and certification of trainee programs, the registration of the apprentices and trainees, and the ratios and wage prescribed in the applicable programs or the Wage Determination.

8.2 Weekly Submissions.

(a) The Contractor shall submit to the Agency on each Wednesday at noon a copy of the payrolls for the week preceding the previous week in which any construction of the Horizontal [Vertical] Improvements was performed. The payrolls submitted shall set out accurately and completely all of the information required by the Agency's Optional Form, an initial supply of which may be obtained from the Agency ("Agency's Optional Form"). The Contractor if a Prime Contractor, or the Developer acting as the Contractor, is responsible for the submission of copies of certified payrolls by all subcontractors; otherwise, each Contractor shall timely submit such payrolls.

(b) Each weekly payroll shall be accompanied by the Statement of Compliance that accompanies the Agency's Optional Form ("Statement of Compliance") and properly executed by the Contractor or his or her agent, who pays or supervises the payment of the employees.

8.3 The Contractor shall make the records required under Section 8 available for inspection or copying by authorized representatives of the Agency, and shall permit such representatives to interview employees during working hours on the job. On request, the Executive Director of the Agency shall advise the Contractor of the identity of such authorized representatives.

Section 9. Occupational Safety and Health. No Laborer or Mechanic shall be required to work in surroundings or under working conditions which are unsanitary, hazardous or dangerous to his or her safety and health as determined under construction safety and health standards promulgated by Cal-OSHA or if Cal-OSHA is terminated, then by the federal OSHA.

Section 10. Equal Opportunity Program. The utilization of apprentices, trainees, Laborers and Mechanics under this Attachment shall be in conformity with the Equal Opportunity Program set forth in Attachment 24 of the Agreement, including Schedules A through C. Any conflicts between the language contained in these Labor Standards and Attachment 24 shall be resolved in favor of the language set forth in Attachment 24, except that in no event shall less than the prevailing wage be paid.

Section 11. Nondiscrimination Against Employees for Complaints. No Laborer or Mechanic to whom the wage, salary or other Labor Standards of this Agreement are applicable shall be discharged or in any other manner discriminated against by the Contractor because such

employee has filed any complaint or instituted or caused to be instituted any proceeding under or relating to these Labor Standards.

Section 12. Posting of Notice to Employees. A copy of the Wage Determination referred to in Section 4.1 together with a copy of a "Notice to Employees," in the form appearing on the last page of these Labor Standards, shall be given to the Developer at the Close of Escrow. The Notice to Employees and the Wage Determination shall both be posted and maintained by the Contractor in a prominent place readily accessible to all applicants and employees performing construction of the Horizontal [Vertical] Improvements before construction commences. If such Notice and Wage Determination is not so posted or maintained, the Agency may do so.

Section 13. Violation and Remedies.

13.1 Liability to Employee for Unpaid Wages. The Contractor shall be liable to the employee for unpaid wages, overtime wages and benefits in violation of these Labor Standards.

13.2 Stop Work -- Contract Terms, Records and Payrolls. If there is a violation of these Labor Standards by reason of the failure of any contract or subcontract for the construction of the Horizontal [Vertical] Improvements to contain the Labor Standards as required by Section 2 ("Non-Conforming Contract"); or by reason of any failure to submit the payrolls or make records available as required by Section 8 ("Non-Complying Contractor"), the Executive Director of the Agency may, after written notice to the Developer with a copy to the Contractor involved and failure to cure the violation within five (5) working days after the date of such notice, stop the construction work under the Non-Conforming Contract or of the Non-Complying Contractor until the Non-Conforming Contract or the Non-Complying Contractor comes into compliance.

13.3 Stop Work and Other Violations. For any violation of these Labor Standards the Executive Director of the Agency may give written notice to the Developer, with a copy to the Contractor involved, which notice shall state the claimed violation and the amount of money, if any, involved in the violation. Within five (5) working days from the date of said notice, the Developer shall advise the Agency in writing whether or not the violation is disputed by the Contractor and a statement of reasons in support of such dispute (the "Notice of Dispute"). In addition to the foregoing, the Developer, upon receipt of the notice of claimed violation from the Agency, shall, with respect to any amount stated in the Agency notice, withhold payment to the Contractor of the amount stated multiplied by forty-five (45) working days; and shall with the Notice of Dispute, also advise the Agency that the monies are being or will be withheld. If the Developer fails to timely give a Notice of Dispute to the Agency or to advise of the withhold, then the Executive Director of the Agency may stop the construction of the Horizontal [Vertical] Improvements under the applicable contract or by the involved Contractor until such Notice of Dispute and written withhold advice has been received.

13.4 Upon receipt of the Notice of Dispute and withhold advice, any stop work which the Executive Director has ordered shall be lifted, but the Developer shall continue to withhold the monies until the dispute has been resolved either by agreement, or failing agreement, by arbitration as is provided in Section 14.

13.5 Withholding Certificates of Completion. The Agency may withhold any or all Certificates of Completion of the Horizontal [Vertical] Improvements provided for in the Agreement, for any violations of these Labor Standards until such violation has been cured.

13.6 General Remedies. In addition to all of the rights and remedies herein contained, but subject to arbitration, except as hereinafter provided, the Agency shall have all rights in law or equity to enforce these Labor Standards including, but not limited to, a prohibitory or mandatory injunction. *Provided, however,* the stop work remedy of the Agency provided above in Sections 13.2 and 13.3 is not subject to arbitration.

Section 14. Arbitration of Disputes.

14.1 Any dispute regarding these Labor Standards shall be determined by arbitration through the American Arbitration Association, San Francisco, California office ("AAA") in accordance with the Commercial Rules of the AAA then applicable, but subject to the further revisions thereof.

14.2 The Agency and all persons or entities who have a contractual relationship affected by the dispute shall be made a party to the arbitration. Any such person or entity not made a party in the demand for arbitration may intervene as a party and in turn may name any such person or entity as a party.

14.3 The arbitration shall take place in the City and County of San Francisco.

14.4 Arbitration may be demanded by the Agency, the Developer or the Contractor.

14.5 With the demand for arbitration, there must be enclosed a copy of these Labor Standards, and a copy of the demand must be mailed to the Agency and the Developer, or as appropriate to one or the other if the Developer or the Agency is demanding arbitration. If the demand does not include the Labor Standards, they are nevertheless deemed a part of the demand. With the demand if made by the Agency or within a reasonable time thereafter if not made by the Agency, the Agency shall transmit to the AAA a copy of the Wage Determination referred to in Section 4 and copies of all notices sent or received by the Agency pursuant to Section 13. Such material shall be made part of the arbitration record.

14.6 One arbitrator shall arbitrate the dispute. The arbitrator shall be selected from the panel of arbitrators of the AAA by the parties to the arbitration in accordance with the AAA rules. The parties shall act diligently in this regard. If the parties fail to select an arbitrator within seven (7) days from the receipt of the panel, the AAA shall appoint the arbitrator. A condition to the selection of any arbitrator shall be that person's agreement to render a decision within thirty (30) days from appointment.

14.7 The decision of the arbitrator shall be final and binding on all of the parties, whether a party participates in the arbitration or not. Any and all rights of appeal from the decision are waived except a claim that the arbitrator's decision violates an applicable statute or regulation. The decision of the arbitrator shall be rendered on or before thirty (30) days from appointment. The arbitrator shall schedule hearings as necessary to meet this thirty (30) day decision requirement and the parties to the arbitration, whether they appear or not, shall be bound

by such scheduling.

14.8 Any party to the arbitration may take any and all steps permitted by law to enforce the arbitrator's decision. If the arbitrator's decision requires the payment of money, the Contractor shall make the required payments and the Developer shall pay the Contractor from money withheld.

14.9 Costs and Expenses. Each party shall bear its own costs and expenses of the arbitration and the costs of the arbitration shall be shared equally among the parties.

Section 15. Non-liability of the Agency. The Developer and each Contractor acknowledge and agree that the procedures set forth herein for dealing with violations of these Labor Standards are reasonable and have been anticipated by the parties in securing financing, in inviting, submitting and receiving bids for the construction of the Horizontal [Vertical] Improvements, in determining the time for commencement and completion of construction and in proceeding with construction work. Accordingly, the Developer and any Contractor, by proceeding with construction, expressly waive and are deemed to have waived any and all claims against the Agency for damages, direct or indirect, arising out of these Labor Standards and their enforcement and including without limitation claims relative to stop work orders, and the commencement, continuance or completion of construction.

SAN FRANCISCO REDEVELOPMENT AGENCY

NOTICE TO EMPLOYEES

EQUAL OPPORTUNITY NON-DISCRIMI- NATION

The contractor must take equal opportunity to provide employment opportunities to minority group persons and women and shall not discriminate on the basis of age, ancestry, color, creed, disability, gender, national origin, race, religion or sexual orientation.

PREVAILING WAGE

You shall not be paid less than the wage rate attached to this Notice for the kind of work you perform.

OVERTIME

You must be paid not less than one and one-half times your basic rate of pay for all hours worked over 8 a day or 40 a week, whichever is greater.

APPRENTICES

Apprentice rates apply only to employees registered under an apprenticeship or trainee program approved by the Bureau of Apprenticeship and Training or the California Division of Apprenticeship Standards.

PROPER PAY

If you do not receive proper pay, write:

San Francisco Redevelopment Agency
770 Golden Gate Avenue
San Francisco, CA 94102-3120
or call **749-2427** and ask for
Mr. Sylvester McGuire
Senior Contract Compliance Specialist

ATTACHMENT 14

SAN FRANCISCO REDEVELOPMENT AGENCY

FORM OF CARD CHECK AGREEMENT

Section 1. Findings and Declarations.

- (a) In the course of managing real property that it owns or in otherwise carrying out its functions in the public interest, the Redevelopment Agency of the City and County of San Francisco (hereinafter the "Agency") occasionally participates in real property development as landlord, proprietor, lender or guarantor, facing the same risks and liabilities as other business entities participating in such ventures. For example, the Agency sometimes leases its real property under a percentage lease, or otherwise invests or pledges its resources in real estate development projects as a landlord, a lender or a guarantor. When it does, the Agency has an ongoing Proprietary Interest in that development, and, thus, has a direct interest in its performance.
- (b) In such situations, the Agency must make prudent business decisions, as would any private business entity, to ensure efficient and cost-effective management of its business concerns, and to maximize benefit and minimize risk. One of those risks is the possibility of labor/management conflict arising out of labor union organizing campaigns. Such conflict can adversely affect the Agency's investment in real estate development or other circumstances in which it has a Proprietary Interest by causing delay in the completion of projects, and/or by reducing revenues or increasing costs of the project when they are completed.
- (c) Although the Agency relies primarily on tax increment financing to finance development projects, including hotel and restaurant projects, it often becomes an investor or economic participant in such projects by negotiating lease or revenue participation arrangements. In such circumstances, labor/management conflicts can be particularly debilitating, not only to the specific Hotel or Restaurant Project, but also to the Agency's ability to finance other redevelopment projects. It is extremely important for the hotel and restaurant development in which the Agency is an investor or other economic participant to be free from labor disputes that have the potential of reducing the revenue of the Hotel or Restaurant Project and thereby reducing the value of the transaction to the Agency. If the value of the transaction is affected adversely, the Agency will receive less revenue from the property, which will reduce the Agency's ability to provide financial support to the hotel or restaurant Developer as well as other redevelopment projects.
- (d) In addition, labor strife in hotel and restaurant projects in which the Agency is an investor or other economic participant can jeopardize the operation of related tourist and commercial facilities, as well as San Francisco's national reputation as a tourist and convention destination.

- (e) To minimize that risk in circumstances where costly labor/management conflict has arisen in the past, the Agency enacts this Policy which requires that certain specified Employers in the hotel and restaurant industry shall agree, as a condition of the Agency's economic involvement in a Hotel or Restaurant Project, to nonconfrontational and expeditious procedures by which their workers can register their presence regarding union representation.
- (f) A major potential source of labor/management conflict that threatens the economic interest of the Agency as a participant in development projects is the possibility of Economic Action taken by labor unions against Employers in those developments when labor unions seek to organize their workers over Employer opposition to unionization. Experience of municipal and other investors has demonstrated that organizing drives pursuant to formal and adversarial union certification processes often deteriorate into protracted and acrimonious labor/management conflict. That conflict potentially can result in construction delays, work stoppages, picketing, strikes and more recently, in consumers boycotts or other forms of "corporate campaigns" that can generate publicity and reduced revenues that threaten the interests not only of the immediate "target" of such tactics, i.e., the Employer, but of other investors in the development, and also the Agency's special interests identified herein.
- (g) These risks of potential labor/management conflict are particularly acute when labor unions seek to organize workers in hotels and restaurants, as labor relations in the hospitality industry in San Francisco have proven especially contentious, and have resulted in many protests, boycotts and other activities which have disrupted the business of the hotel or restaurant and the tourist industry and the downtown hotel area.
- (h) In view of these concerns, the Agency deems it necessary to approach with great caution any economic participation in a Hotel or Restaurant Project if the Agency retains a Proprietary Interest, either as landlord, lender or guarantor. The Agency finds that a cautionary approach to be particularly appropriate given other possible factors present in such developments, such as the Agency's sometimes special Proprietary Interest or other special concerns identified herein, and/or their complex financing schemes, the possible use of scarce land resources, as well as the dependence of such projects on public "good will" and the special vulnerability of such projects to consumer boycotts, etc.
- (i) One way to reduce the Agency's risk where it has a Proprietary Interest in a Hotel or Restaurant Project is to require, as a condition of the Agency's investment or other economic participation, that Employers operating in the Hotel or Restaurant Project agree to a lawful, nonconfrontational alternative process for resolving a union organizing campaign. That alternative process is a so-called "Card Check," wherein employee preference regarding whether or not to be represented by a labor union to act as their exclusive collective bargaining representative is determined based on signed authorization cards. Private Employers are authorized under existing federal law to agree voluntarily to use his procedure in lieu of NLRB-supervised election procedures.
- (j) The Agency Commission finds based on the City's history that compliance with these procedures will help reduce the possibility of labor/management conflict jeopardizing the

Agency's Proprietary Interest in a Hotel or Restaurant Project. To ensure that card check procedures are required only to the extent necessary to ensure the goal of minimizing labor/management conflict, an Employer who agrees to such procedures and performs its obligation under a Card Check Agreement will be relieved of further obligation to abide by those procedures if a Labor Organization engages in Economic Action such as striking, picketing or boycotting the Employer in the course of an organizing drive and at a site covered by this Policy.

- (k) The sole purpose of this Policy is to protect the Agency's Proprietary Interest in particular Hotel and Restaurant Projects covered hereby. This Policy is not enacted to favor any particular outcome in the determination of Employer preference regarding union representation, nor to skew the procedures in such a determination to favor or hinder any party such determination. Likewise, this Policy is not intended to enact or express any generally applicable policy regarding labor/management relations, or to regulate those relations in any way, but is intended only to protect the Agency's Proprietary Interest in certain narrowly prescribed circumstances where the Agency commits its economic resources and/or its related interests are put at risk by certain forms of labor/management conflict.

Section 2. Definitions.

For purposes of this Policy, the following definitions shall apply:

- (a) "Card Check Agreement" means a written agreement between an Employer and a Labor Organization providing a procedure for determining employee preference on the subject of whether to be represented by a Labor Organization for collective bargaining, and if so, by which Labor Organization to be represented, which provides, at a minimum, the following:
 - (i) Determining employee preference regarding union representation shall be by a card check procedure conducted by a neutral third party in lieu of a formal election;
 - (ii) All disputes over interpretation or application of the parties' Card Check Agreement, and over issues regarding how to carry out the card check process or specific card check procedures shall be submitted to binding arbitration;
 - (iii) Forbearance by any Labor Organization from Economic Action against the Employer at the worksite of an organizing drive covered by this Policy, and in relation to an organizing campaign only (not to the terms of a Collective Bargaining Agreement), so long as the Employer complies with the terms of the Card Check Agreement;
 - (iv) Language and procedures prohibiting the Labor Organization or the Employer from coercing or intimidating employees, explicitly or implicitly, in selecting or not selecting a bargaining representative.

- (b) "Agency Contract" means a Disposition and Development Agreement, lease, management agreement, service agreement, loan, bond, guarantee, or other similar agreement to which the Agency is a party and in which the Agency has a Proprietary Interest.
- (c) "Collective Bargaining Agreement" means an agreement between an Employer and a Labor Organization regarding wages, hours and other terms and conditions of employment of the Employer's employees. For purposes of this Policy, a Collective Bargaining Agreement does not include a Card Check Agreement as defined herein.
- (d) "Developer" means any person, corporation, association, general or limited partnership, limited liability company, joint venture or other entity which does or which proposes to purchase, lease, develop, build, remodel or otherwise establish a Hotel or Restaurant Project.
- (e) "Economic Action" means concerted action initiated or conducted by a labor union and/or employees acting in concert therewith, to bring economic pressure to bear against an Employer, as part of a campaign to organize employees or prospective employees of that Employer, including such activities as striking, picketing, or boycotting. A lawsuit to enforce this Policy is not "Economic Action."
- (f) "Employer" means any Developer, Manager/Operator or subcontractor who employs individuals in a hotel or restaurant in a Hotel or Restaurant Project.
- (g) "Hotel or Restaurant Project" means a development project or facility in which the Agency has a Proprietary Interest and which contains a hotel or restaurant. For purposes herein a "hotel" shall mean any use or facility falling within either definition of Section 314.1(g) or (h) of the San Francisco Planning Code. For purposes herein a "restaurant" shall mean any facility that has as its principal purpose the sale of food and beverage for primarily on-site consumption, including any such facility operating within or as part of another facility, such as a stadium, hotel or retail store. A Hotel or Restaurant Project, as defined herein, includes a mixed-use development project in which the Agency has a Proprietary Interest which contains a hotel or restaurant, regardless of whether the Agency's Proprietary Interest is in the hotel or restaurant portion of such mixed use development or the mixed-use development project as a whole. Notwithstanding the foregoing or anything else contained herein, the requirement in this Policy that an Employer enter into a Card Check Agreement shall apply only to those Employers who employ employees in a hotel or restaurant and shall not apply to those portions of a mixed-use development project which do not contain a hotel or restaurant.
- (h) "Labor Organization" means any organization of any kind, or any agency or employee representation committee or plan, in which employees participate and which exists for the purpose, in whole or in part, of dealing with Employers concerning grievances, labor disputes, wages, rates of pay, hours of employment, or conditions of work.
- (i) "Manager/Operator" means any person, corporation, association, limited or general partnership, joint venture or other entity (including a Developer) that operates or manages

a hotel or restaurant in a Hotel or Restaurant Project, or provides any material portion of the services provided by such hotel or restaurant in a Hotel or Restaurant Project, whether by Subcontract or Agency Contract.

- (j) “Proprietary Interest” means any nonregulatory arrangement or circumstance in which the financial or other nonregulatory interests of the Agency in a Hotel or Restaurant Project could be adversely affected by labor/management conflict or consumer boycotts potentially resulting from a union organizing campaign, in the following circumstances:
- (i) The Agency receives significant ongoing revenue (such as rent payments) under a lease or real property owned by the Agency for the development of a Hotel or Restaurant Project, excluding government fees or tax or assessment revenues, or the like (except for tax revenues under the circumstances specified in (ii)); or
 - (ii) The Agency receives ongoing revenue from a Hotel or Restaurant Project to pay debt service on bonds or loans provided by the Agency to assist the development of such Hotel or Restaurant Project (including incremental tax revenues generated by the Hotel or Restaurant Project or the development project in which it is located and used, directly or indirectly, to pay debt service on bonds or to repay a loan by the Agency where the proceeds are used for development of that Hotel or Restaurant Project or the development project in which it is located);
 - (iii) The Agency has agreed to underwrite or guarantee the development or operation of a Hotel or Restaurant Project, or loans related thereto;
 - (iv) The Agency receives a continuing financial payment that is specific to that Hotel or Restaurant Project, which is not a tax or other charge of general applicability or a one-time payment for the land;
 - (v) The Agency receives a share in the profits of a hotel in negotiated economic participation agreement.
- (k) In addition to the circumstances described in (i) — (v) above, the Agency shall be deemed to have a Proprietary Interest in a Hotel or Restaurant Project if the Agency determines or an interested party demonstrates prior to the effective date of the Subcontract or Agency Contract pursuant to which a hotel or restaurant will be operated in a Hotel or Restaurant Project that there is a significant risk that the Agency’s financial or other nonregulatory interest in a Hotel or Restaurant Project could be adversely affected by labor/management conflict or consumer boycotts potentially resulting from a union organizing campaign, except that no circumstances or arrangement shall be considered “financial or non-regulatory” under this definition if it arises from the exercise of regulatory or police powers such as taxation or the receipt of tax increment funds as provided in Article 16, section 16 of the California Constitution (except as provided in (ii) above), zoning or the issuance of permits and licenses.
- (l) “Subcontract” means any lease, sublease, management agreement or other similar agreement between a Developer or a Manager/Operator and a subcontractor which

contemplates or permits the subcontractor to operate or manage all or a portion of a hotel or restaurant in a Hotel or Restaurant Project.

- (m) "Subcontractor" means any person, corporation, association, limited or general partnership, limited liabilities company, joint venture or other entity that enters into a Subcontract with a Developer or Manager/Operator.
- (n) "Substantial Amendment" to a pre-existing agreement, for purposes of the exemption for Employers operating before the effective date of Section 4(b)(ii) of this Policy, means an amendment to or renewal or extension of a pre-existing agreement that provides for or permits any of the following:
 - (i) a change in use with the scope of this Policy (i.e., which provides for the operation of a hotel or restaurant);
 - (ii) an increase in square footage, seating or rooms of more than 25%; except neither of the following, by themselves, shall constitute a "Substantial Amendment":
 - (I) addition of outside seating or patio dining which increases the total seating or square footage devoted to seating by less than 25%;
 - (II) an increase in space for purpose of parking or storage; or
 - (iii) a new lease period of greater duration than the period provided in the pre-existing agreement.

Section 3. Policy, Requirements and Procedures to Minimize Labor/Management Conflict when the Agency has a Proprietary Interest.

- (a) General Policy. The Agency Commissioners declare as a matter of general policy that when the Agency retains or acquires a Proprietary Interest in a Hotel or Restaurant Project, it is essential for the protection of the Agency's investment and/or business interests to require that Employers operating a hotel or restaurant in such Hotel or Restaurant Project agree to abide by card check procedures for determining employee preference on the subject of labor union representation, as specified in this Policy.
- (b) Primary Obligations. Pursuant to the policy stated in Subsection (a), the following requirements are imposed, except no Employer, Developer or Manager/Operator shall be responsible for obligations under this Policy if that person or entity is otherwise exempt from those obligations pursuant to Section 4(b), or if the Agency does not have a Proprietary Interest in the subject Hotel or Restaurant Project:
 - (i) Employers. An Employer of employees working in a hotel or restaurant in a Hotel or Restaurant Project, shall:
 - (I) Enter into a Card Check Agreement, as specified in this Policy, with a Labor Organization which requests such an agreement for the purpose of seeking to represent those employees before executing the Subcontract or

Agency Contract pursuant to which it operate a hotel or restaurant in a Hotel or Restaurant Project.

- (II) If the parties are unable to agree to the terms of a Card Check Agreement within 60 days of the commencement of such negotiations, they must enter into expedited binding arbitration in which the terms of a Card Check Agreement will be imposed by an arbitrator. In such proceeding, to be conducted by an experienced labor arbitrator selected as provided by the rules of the American Arbitration Association or equivalent organization, the arbitrator shall consider any model Card Check Agreement provided by the Agency and/or to prevailing practices and the terms of Card Check Agreement(s) in the same or similar industries, except that such Card Check Agreement must include the mandatory terms identified in Section 2(a);
- (III) Comply with the terms of that Card Check Agreement and this Policy; and
- (IV) Include in any Subcontract which contemplates or permits a Subcontractor to operate or manage a hotel or restaurant in a Hotel or Restaurant Project, as defined herein, or to provide a service essential to the operation of such a hotel or restaurant, a provision requiring that Subcontractor to comply with the requirements provided in this Policy. This provision shall be a material and mandatory term of such Subcontract, binding on all successors and assigns, and shall state (modified as necessary to accommodate particular circumstances):

“The Redevelopment Agency of the City and County of San Francisco has enacted the Card Check Neutrality Policy, which may apply to [Subcontractor]. Its terms are expressly incorporated by reference hereto. To the extent [Subcontractor] or its successors or assigns employs employees in a hotel or restaurant in [this facility] within the scope of that Policy, [Subcontractor] hereby agrees as a material condition of this [Subcontractor] to enter into and abide by a Card Check Agreement with a Labor Organization or Organizations seeking to represent [Subcontractor’s] employees, if and as required by that Policy, and to otherwise fully comply with the requirements of that Policy. [Subcontractor] recognizes that, as required by that Policy, it must enter into a Card Check Agreement with a Labor Organization or Organizations as specified by that Policy before executing this [Subcontractor], and that being party to such a Card Check Agreement(s) is a condition precedent of rights or obligations under this [Subcontract].”

- 1) Notwithstanding the requirements provided in (I) — (IV), any Employer who has in good faith fully complied with those requirements will be excused from further compliance as to a Labor Organization which has taken Economic Action against that Employer at that site in furtherance of a campaign to organize that

Employer's employee at that site for collective bargaining. This clause shall not be interpreted, however, to apply to Economic Action against an Employer at other locations where that Employer does business, or at any location for purposes other than organizing the Employer's employees; nor shall Economic Action by one Labor Organization excuse an Employer from the obligations of this Policy or a Card Check Agreement as to a different Labor Organizations.

- (ii) Developers and Manager/Operators. Any Developer or Manager/Operator of a Hotel or Restaurant Project must:
- (I) To the extent it employs employees in a hotel or restaurant in a Hotel or Restaurant Project, abide by the requirements stated in Subsection (i);
 - (II) Include the provision specified in (i)(IV) in any Subcontract, modified as necessary to accommodate the circumstances of that particular Subcontract;
 - (III) Refrain from executing a Subcontract by which an Employer subject to (i) is authorized or permitted to operate a hotel or restaurant in a Hotel or Restaurant Project until that Employer has entered into a Card Check with Labor Organization, as required in (i);
 - (IV) Notify local labor council(s) and/or federation(s) of any hotel(s) or restaurant(s) and/or any Employer(s) that will operate a hotel or restaurant in a Hotel or Restaurant Project which may be subject to the requirements of (i), as soon as the Developer or Manager/Operator identifies such hotel(s) or restaurant(s) or Employer(s), but in no event later than 21 days before requiring an Employer to sign Subcontract. This notification requirement applies only to hotels or restaurants or Employers that will operate in a Hotel or Restaurant Project, as defined herein and only where the Agency's Proprietary Interest is based on a lease, a loan or a guarantee, as specified in Section 2(j)(i)-(v);
 - (V) Inform any prospective Subcontractor, that if the Subcontractor acts as an Employer subject to the requirements of (i), it must enter into a Card Check Agreement pursuant to this Policy before it may execute the Subcontract, and as a condition precedent to any rights or obligations under such document;
 - (VI) Take reasonable steps to enforce the terms of any Subcontract requiring compliance with this Policy. To the extent a Developer or Manager/Operator is found to have intentionally aided, abetted or encouraged a Subcontractor's failure to comply with such a provision or the terms of this Policy, either by action or inaction, that Developer or

Manager/Operator shall be jointly and severally liable for all damages award pursuant to Section 5.

- (iii) The Agency.
- (I) Agency Contracts. Any Agency Contract which contemplates the use or operation of a hotel or restaurant in a Hotel or Restaurant Project must include provision requiring that any Developer or operator/manager of a Hotel or Restaurant Project pursuant to that Agency Contract, and any Employer(s) operating in such Hotel or Restaurant Project, agree to comply with the requirements imposed in Subsections (i) and (ii), as essential consideration for the Agency entering into the Agency Contract.
- (II) Model Card Check Agreement. To facilitate the requirements imposed by this Section, the Agency or Agency's designee may provide a model recommended Card Check Agreement that includes the mandatory terms identified in Section 2(a0 and which provides the maximum protection against labor/management conflict arising out of an organizing drive, and make such model recommended agreement available to parties required to enter into such agreement. The Agency may also prepare guidelines establishing standards and procedures related to this Policy. Notwithstanding this provision regarding the preparation of a model Card Check Agreement or related guidelines, this Policy shall be self-executing, and shall apply in all circumstances and to the extent provided in this Policy, in the absence of or regardless of such Model Card Check Agreement guidelines.
- (III) Requests for Proposals ("RFPs"). Any request for proposals or invitation to bid or similar document regarding development of Agency property which could result in a proposal contemplating operation of a Hotel or Restaurant Project after the effective date of this Policy, must include in such document a summary description of and reference to the policy and requirements of this Policy. Failure to include description or reference to this Policy in an RFP or similar document shall not exempt any Developer, or Manager/Operator or Employer otherwise subject to the requirements of this Policy.
- (c) Applicability of This Policy. The Policy and obligations established above shall apply to particular Developers, Manager/Operators and Employers whenever the Agency has a Proprietary Interest in a Hotel or Restaurant Project, except as otherwise provided hereunder. The determination whether or not the Agency has a Proprietary Interest in a Hotel or Restaurant Project, and if so, whether an exemption applies under Section 4(b), shall be made on a case-by-case basis by the Executive Director by applying the standards and principles described herein and any further standards and principles provided in guidelines distributed pursuant to Section 3(b)(iii)(II) hereof. Any party otherwise subject to the terms of this Policy because the Agency has Proprietary Interest in a Hotel or Restaurant Project defined in Section 2(j)(i)— (v) above that claims an

exemption from the terms of this Policy under Section 4 below shall have the burden of demonstrating that the basis for such exemption is clearly present.

Section 4. Scope and Exemptions.

- (a) **Scope.** The requirements of this Policy apply only to the procedures for determining employee preference regarding whether to be represented by a Labor Organization for purposes of collective bargaining and/or by which Labor Organization to be represented. Accordingly, this Policy does not apply to the process of collective bargaining in the event a Labor Organization has been recognized as the bargaining representative for employees of Employers subject to this Policy. Moreover, nothing in this Policy requires an Employer or other entity subject to this Policy to recognize a particular Labor Organization; nor does any provision of this Policy require that a Collective Bargaining Agreement be entered into with any Labor Organization, or that an Employer submit to arbitration regarding the terms of a Collective Bargaining Agreement.
- (b) **Exemptions.** The requirements of this Policy shall not apply to:
 - (i) Employers employing fewer than the equivalent of 50 full-time or part-time employees, provided that when a restaurant is located on the same premises as a hotel and routinely provides food or beverage services to the hotel's guests, employees of the restaurant and hotel shall be aggregated for purposes of determining the applicability of this Policy.
 - (ii) Employers commencing operation in a hotel or restaurant in a Hotel or Restaurant Project before the effective date of this Policy, or a Hotel or Restaurant Project under any Subcontract or Agency Contract entered into before the effective date of this Policy ("pre-existing agreement"). This exemption applies to an Employer and to his or her family for the duration of such pre-existing agreement, unless it is amended during its term resulting in a Substantial Amendment, as defined in Section 2(n). This exemption shall apply beyond the expiration of the pre-existing agreement if it is renewed or extended without a change in ownership of the Employer, and without changes resulting in Substantial Amendment, as defined in Section 2(n). For purposes of this exemption, "change in ownership" shall mean a change in ownership, from the effective date hereof, of 25% or more, unless such change is among members of the same family; or
 - (iii) Any Employer which is signatory to a valid and binding Collective Bargaining Agreement covering the terms and conditions of employment for its employees at the Hotel or Restaurant Project, or which has entered into a Card Check Agreement with a Labor Organization regarding such employees which agreement provides at least equal protection from labor/management conflict as provided by the minimum terms provided in Section 2(a); or
 - (iv) Any Hotel or Restaurant Project where the Executive Director determines that the risk to the Agency's financial or other nonregulatory interest resulting from

labor/management conflict is so minimal or speculative as not to warrant concern for the Agency's investment or other nonregulatory interest; or

- (v) Any Hotel or Restaurant Project where the Developer, Manager/Operator or Employer, is an agency of the federal government or a statewide agency or entity ("Public Agency") and that Public Agency would prohibit application of this Policy; or
- (vi) Any Hotel or Restaurant Project where the requirements of this Policy would violate or be inconsistent with the terms or conditions of a grant, subvention or agreement with the Public Agency related to such Hotel or Restaurant Project, or any related rules or regulations.

Section 5. Enforcement.

- (a) The requirement that Employers enter into and comply with Card Check Agreement with Labor Organizations in the circumstances provided in this Policy, and the requirement that Developers or Manager/Operators contractually obligate their successors, assigns or Subcontractors to be bound by that former requirement are essential consideration for the Agency's agreement to any Agency Contract containing that requirement.
- (b) The Agency shall investigate complaints that this Policy has been violated or that a card check provision included in an Agency Contract or Subcontract pursuant to this Policy has been breached, and may take any action necessary to enforce compliance, including but not limited to instituting a civil action for an injunction and/or specific performance.
- (c) In the event the Agency brings a civil enforcement action for violation of this Policy, any taxpayer or any person or association by or with a direct interest in compliance with this Policy may join in that enforcement action as a real party in interest. In the event the Agency declines to institute a civil enforcement action for violation of this Policy, a taxpayer or directly interested person or association may bring a civil proceeding on its own behalf and on behalf of the Agency against that Employer and seek all remedies available for violation of this Policy and/or breach of a Card Check Agreement required by this Policy available under state law, including but not limited to monetary, injunctive and declaratory relief. In view of the difficulty of determining actual damages incurred by such a violation, liquidated damages may be awarded at the rate of \$1,000 per day of violation, to be distributed equally between a private plaintiff, if any, and the Agency Fund, unless such liquidation damages award is found to be so excessive in relation to the violator's resources as to constitute a penalty.
- (d) Any action challenging the applicability of this Policy to a particular Employer may be brought only after first seeking an exemption pursuant to Section 4, and must be commenced within 60 days after notification that such exemption has been denied by the Agency.
- (e) Notwithstanding anything else contained herein, in no event shall the remedy for a breach of the terms of this Policy include termination of any such Subcontract or Agency Contract, nor shall any such breach defeat or render invalid or affect in any manner

whatsoever the status priority of the lien of any mortgage, deed of trust or other security interest made for value and encumbering any property affected by such Subcontract or Agency Contract, including, without limitation, any leasehold estate or other interest in such property or improvements on such property.

Section 6. Effective Date and Application.

- (a) This Policy shall become effective immediately after it is enacted, is intended to have prospective effect only, and shall not be interpreted to impair the obligations of any pre-existing agreement to which the Agency is a party, unless such pre-existing agreement has been Substantially Amended after the effective date of this Policy.

Section 7. Severability.

- (a) If any part or provision of this Policy, or the application thereof to any person or circumstance, is held invalid, the remainder of this Policy, including the application of such part or provisions to other persons or circumstances, shall not be affected thereby and shall continue in full force and effect. To this end, the provisions of this Policy are severable.

RESOLUTION NO. 204-99
(Adopted December 7, 1999)

**AUTHORIZING THE ADOPTION OF THE "CARD CHECK NEUTRALITY"
POLICY REQUIRING EMPLOYERS OF A HOTEL AND RESTAURANT
DEVELOPMENT TO ABIDE BY CARD CHECK PROCEDURES FOR
DETERMINING EMPLOYEES' PREFERENCE REGARDING UNION
REPRESENTATION WHEN THE AGENCY RETAINS A PROPRIETARY
INTEREST IN A HOTEL OR RESTAURANT DEVELOPMENT;
ALL REDEVELOPMENT PROJECT AREAS**

BASIS FOR RESOLUTION

1. The Redevelopment Agency of the City and County of San Francisco (the Agency) has an ongoing proprietary interest in real property development as landlord, proprietor, lender or guarantor, facing the same risks and liabilities as other business entities participating in such ventures.
2. The Agency wishes to require that employers operating hotel or restaurant projects agree, as a condition of the Agency's investment or economic participation in such a project, to a process called "Card Check," a non-confrontational and expeditious procedure by which workers can register their preference regarding union representation on a signed authorization card.
3. The goal of the Card Check process is to minimize the risk of the possibility of labor/management conflict arising out of labor union organizing campaigns that might adversely affect the Agency's investment in real estate developments by causing delays in the completion of projections and/or reducing revenue or increasing costs of projects when they are completed.
4. Labor/management organizing campaigns are a potential source of conflict that threaten the economic interest of the Agency as a participant in hotel development projects because of the possibility of economic action taken by labor unions against employers in those developments when labor unions seek to organize their workers over employer opposition to unionization.
5. The Card Check process is not intended to regulate labor/management relations in any way, but is intended only to protect the Agency's proprietary interest in prescribed circumstances where the Agency's economic resources and/or its related interests are put at risk by certain forms of labor/management conflict.

RESOLUTIONS

ACCORDINGLY, IT IS RESOLVED by the Redevelopment Agency of the City and County of San Francisco that the attached Card Check Neutrality Policy is hereby adopted.

APPROVED AS TO FORM:

ROBERT A. FIREHOCK
Acting Agency General Counsel

ATTACHMENT 15

MINIMUM COMPENSATION POLICY

This Minimum Compensation Policy (the "Policy") is attached to and made a part of the Disposition and Development Agreement (the "Agreement") for Hunters Point, Phase 1 ("Phase 1"). Developer is bound by this Attachment as part of the obligations it assumes and benefits it receives under the Agreement.

Section 1. Findings and Declarations.

1.1 The Redevelopment Agency of the City and County of San Francisco (the "Agency") enters into many contracts, including, but not limited to, service contracts, loan and grant agreements, and property agreements, in furtherance of the objectives of the California Community Redevelopment Law (Health and Safety Code §§ 33000 *et seq.*) in the interest of the health, safety and general welfare of the City of San Francisco's (the "City") residents.

1.2 These contracts and agreements have at times involved compensation to the contracting parties' or their subcontractors' employees that is at or only slightly above the minimum wage levels required by federal and state laws. The compensation paid by some Agency contractors and their subcontractors fails to provide employees with sufficient resources to afford life in the City. Requiring these contracting parties and their subcontractors to provide a minimum level of compensation to their employees will improve the health, safety and general welfare of San Francisco's residents, by, among other things, decreasing poverty and invigorating neighborhood businesses through increased consumer income.

Section 2. Definitions.

Terms not defined in this Attachment have the meanings given to them in the Agreement.

Agency means the Redevelopment Agency of the City and County of San Francisco.

Agency Property means real property that is owned by the Agency or over which the Agency has exclusive use. "Exclusive use" means the right to use or occupy real property to the exclusion of all others, subject to the rights reserved by the party granting such exclusive use.

Agreement has the meaning set forth in the Preamble.

Business Day means a day other than Saturday, Sunday or a state or federal holiday.

City means the City and County of San Francisco, California, a municipal corporation.

Contract means an agreement or portion of an agreement that provides for services to be purchased at the expense of the Agency or out of funds established by ordinance, Memorandum of Understanding (MOU) or otherwise controlled by the Agency. The term Contract includes, without limitation, Property Agreements, Included Subcontracts and agreements such as grant agreements, pursuant to which agreements the Agency grants funds to a Contractor for services (including, without limitation, cultural activities, performances or exhibitions) to be rendered to all or any portion of the public rather than to Agency. Notwithstanding the foregoing, the term Contract excludes:

- (a) Excluded Subcontracts;
- (b) any agreement with a Contractor that, together with the Employees of any Included Subcontractor and of any entity that is owned or controlled by the Contractor or which owns or controls the Contractor, would have twenty (20) or fewer Employees;
- (c) agreements for the purchase or lease of goods or for guarantees, warranties, shipping, delivery or initial installation of such goods;
- (d) agreements entered into pursuant to settlement of legal proceedings;
- (e) agreements for urgent or specialized litigation requirements where the Agency General Counsel finds that it would be in the best interests of the Agency not to include the requirements of this Policy;
- (f) agreements with any person or entity in which the cumulative amount of compensation payable to such person or entity under all agreements with the Agency is less than twenty-five thousand dollars (\$25,000.00), or fifty thousand dollars (\$50,000.00) in the case of Nonprofit Corporations, in any fiscal year, provided that the agreement in question shall be deemed a Contract on and after the effective date of any instrument which causes such cumulative compensation under all agreements with the Agency to exceed twenty-five thousand dollars (\$25,000.00), or fifty thousand dollars (\$50,000.00) in the case of Nonprofit Corporations;
- (g) agreements for the investment, management or use of trust assets where compliance with this Policy would violate the fiduciary duties of the trustee;
- (h) agreements entered into prior to the Effective Date (unless and until a Contract Amendment is entered into);
- (i) agreements entered into after the Effective Date (unless and until a Contract Amendment is entered into) pursuant to, and within the scope of, bid packages or requests for proposals advertised and made available to the public prior to the Effective Date, which bid packages or requests for proposals were not amended on or after the Effective Date;

(j) agreements involving the expenditure by the Agency of grant or special funds to the extent the application of this Policy would violate or be inconsistent with the terms or conditions of the applicable grant agreement, or with the rules, regulations or instructions of the public agency administering such grant agreement, which terms or conditions or rules, regulations or instructions provide for compensation lower than the Minimum Compensation and/or to the extent that application of this Policy would require the Agency to use Agency monies to supplement the grants, special funds or other non-General Fund revenues to maintain the current level of services;

(k) agreements with a Contractor that is a public entity;

(l) agreements for employee benefits to be provided to Agency employees, where the Executive Director finds that no entity is willing to comply with this Policy and is capable of providing the required employee benefits;

(m) agreements that require the Contractor to pay no less than the "prevailing rate of wage" in accordance with state or federal law or Agency policy, but only to the extent (A) each Covered Employee is covered by such requirement, and (B) such prevailing rate of wage is not less than the gross hourly compensation required under Section 3 of this Policy;

(n) agreements for the investment of Agency monies where the Executive Director finds that requiring compliance with this Policy will violate the Agency's fiduciary duties and for the investment of retirement, health or other funds held in trust pursuant to federal, state or local law, or MOU where the official or officials responsible for investing or managing such funds finds that requiring compliance with this Policy will violate their fiduciary duties;

(o) agreements made in connection with loans or grants under which the Agency, as creditor or grantor, is providing funds to be used by the debtor or grantee to: (A) acquire an interest in real property on which residential improvements for low- or moderate-income households will be constructed; (B) construct improvements owned or leased by the debtor or grantee, on condition that residents of the improvements qualify as low- or moderate-income households; or (C) rehabilitate improvements owned or leased by the debtor or grantee;

(p) disposition and development or ground lease agreements of Agency Property on which residential improvements for low-or-moderate income households will be constructed or existing improvements will be operated for low-or-moderate income households; provided, however, that any leases for commercial space in such properties shall be considered Included Leases and shall be subject to the requirements of this Policy;

(q) agreements with an owner (such as an owner participation agreements) where such agreement is granted from the exercise of the Agency's regulatory or police powers not requiring any discretionary approvals by the Agency.

Contract Amendment means an agreement entered into on or after the Effective Date, pursuant to which a Contract entered into prior to the Effective Date is modified or supplemented in order to: (a) extend the term; (b) modify the total amount of payments due from the Agency under a Contract; or (c) modify the scope of services to be performed by a Contractor. The term does not include construction change orders.

Contractor means either: (a) the person or entity that enters into a Contract with the Agency; (b) in the case of an Included Subcontract, the subcontractor who enters into the Included Subcontract with the Contractor; or (c) in the case of an Included Tenant, the Tenant who enters into the Included Lease with the Contractor.

Covered Employee means:

(a) An Employee of a Contractor who, during the applicable Pay Period, performs at least four (4) hours per week during the Pay Period work funded (in whole or in part) under the applicable Contract or to the project funded under the applicable Contract:

(i) within the geographic boundaries of the City;

(ii) on real property owned or controlled by the Agency, but outside the geographic boundaries of the Agency; or

(iii) elsewhere in the United States, but only if such related work performed elsewhere within the United States consists of at least ten (10) hours per each work week during the Pay Period in question.

(b) Notwithstanding the foregoing, the term Covered Employee excludes the following Employees of a Contractor that is a Nonprofit Corporation:

(i) Any Employee who is:

(A) under the age of eighteen (18) and is claimed as a dependent for federal income tax purposes and is employed as an after-school or summer Employee; or

(B) employed as a trainee in a bona fide training program consistent with federal law, which training program enables the Employee to advance into a permanent position; provided, however, these exemptions only apply when the Employee does not replace, displace or lower the wage or benefits of any existing position or Employee; and

(ii) Any disabled Employee of a Contractor, which disabled Employee:

(A) is covered by a current sub-minimum wage certificate issued to the

Contractor by the U.S. Department of Labor; or

(B) would be covered by such a certificate but for the fact that the Contractor is paying a wage equal to or higher than the minimum wage.

Effective Date means the date the Agency Commission approves this Policy.

Employee means any person who is employed by a Contractor, including part-time and temporary employees.

Excluded Subcontract means any agreement or portion of an agreement between a Contractor and a person or entity that is not an Employee of such Contractor, which agreement or portion of an agreement relates to a Contract but is not an Included Subcontract. The term Excluded Contract includes, without limitation, an agreement pursuant to which a Contractor obtains from such a person or entity goods to be used in the fulfillment of the Contractor's duties under the applicable Contract. The term also includes agreements (including, without limitation, any permit to enter or license for a term of less than one hundred and twenty (120) days or any easement agreement) for the exclusive use of real property owned by the Agency or of which the Agency has exclusive use, other than Property Agreements.

Included Lease means a lease, sublease or other agreement with any person or entity for the exclusive right to occupy or use all or any portion of real property owned, leased or otherwise controlled by the Agency or real property in which the Agency has a Proprietary Interest.

Included Subcontract means an Included Lease or an agreement or portion of an agreement between a Contractor and a person or entity who is not an Employee of such Contractor, pursuant to which such person or entity:

(a) agrees to assist a Contractor in performing a Contract; or

(b) agrees to assist a Contractor with a project funded by grant monies conveyed to the Contractor under the applicable Contract. An agreement to assist a Contractor means an agreement to perform all or a portion of a component of the services covered by the Contract with the Agency.

Included Subcontractor means a Subcontractor who enters into an Included Subcontract.

Lease means a written agreement (including, without limitation, any lease, concession or license) in which:

(a) the Agency gives to another party the exclusive use of Agency Property for a term exceeding one hundred and twenty (120) consecutive days in any calendar year,

whether by single or cumulative instruments. If cumulative instruments cause the term of the agreement to exceed one hundred and twenty (120) consecutive days, the agreement shall be subject to this Policy only on or after the effective date of the instrument which causes the term to exceed one hundred and twenty (120) consecutive days. The term Lease includes Lease Amendment.

(b) the Contractor gives to another party the exclusive use of property in which the Agency has a Proprietary Interest for a term exceeding one hundred and twenty (120) consecutive days in any calendar year, whether by single or cumulative instruments. If cumulative instruments cause the term of the agreement to exceed one hundred and twenty (120) consecutive days, the agreement shall be subject to this Policy only on or after the effective date of the instrument which causes the term to exceed one hundred and twenty (120) consecutive days.

Lease Amendment means a modification to a Lease that extends the term or materially changes any other provision of the Lease. Notwithstanding the foregoing, "Lease Amendment" does not include a one-time extension of the term of a Lease for up to six (6) months, or relocation of the leased premises at the request of the Agency for its benefit or convenience (as determined by the Agency Executive Director).

Minimum Compensation means each of the components required under Section 3 of this Policy.

Nonprofit Corporation means a nonprofit corporation, duly organized, validly existing and in good standing under the laws of the jurisdiction of its incorporation and (if a foreign corporation) in good standing under the laws of the State of California, which corporation has established and maintains valid nonprofit status under Section 501(c)(3) of the United States Internal Revenue Code of 1986, as amended, and all rules and regulations promulgated under such Section.

Policy has the meaning set forth in the Preamble.

Property Agreements means Disposition and Development Agreements (DDAs), ground leases, and any other agreements with the Agency (other than Excluded Subcontracts) in which the Agency has a Proprietary Interest.

Proprietary Interest means any nonregulatory arrangement or circumstance in which the financial or other nonregulatory interests of the Agency in a Contract could be adversely affected, in the following circumstances:

(a) The Agency receives significant ongoing revenue (such as rent payments) under a lease or ground lease of real property owned by the Agency for the development of a project pursuant to a Contract, excluding government fees or tax or assessment revenues, or the like (except for tax revenues under the circumstances specified in (b) below); or

(b) The Agency receives ongoing revenue from a project pursuant to a Contract to pay debt service on bonds or loans provided by the Agency to assist the development of such project (including incremental tax revenues generated by the project or the development project in which it is located and used, directly or indirectly, to pay debt service on bonds or to repay a loan by the Agency where the proceeds are used for development of that project or the development project in which it is located;

(c) The Agency has agreed in a Contract to underwrite or guarantee the development or operation of a development project, or loans related thereto;

(d) The Agency pursuant to a Contract receives a continuing financial payment that is specific to that project, which is not a tax or other charge of general applicability or a one-time payment for the land;

(e) The Agency receives a share in the profits of a project in a negotiated economic participation agreement pursuant to a Contract;

(f) In addition to the circumstances described above, the Agency shall be deemed to have a Proprietary Interest in a Contract for a project if the Agency determines, or an interested party demonstrates, prior to the effective date of the Contract pursuant to which a project will be operated that there is a significant risk that the Agency's financial or other nonregulatory interest in the project could be adversely affected, except that no circumstance or arrangement shall be considered "financial or nonregulatory" under this definition if it arises from the exercise of regulatory or police powers such as taxation or the receipt of tax increment funds as provided in Article 16, Section 16 of the California Constitution (except as provided in (b) above), zoning or the issuance of regulatory permits.

Pay Period means the applicable Contractor's regular pay period.

Sublease means any agreement with any person or entity for the exclusive right to occupy or use all or any portion of City Property covered by a Lease. Notwithstanding the foregoing, the term Sublease does not include each of the circumstances that constitute an exclusion from the definition of "Lease."

Subtenant means a person or entity that enters into a Sublease.

Tenant means the person or entity that enters into a Lease with the City.

Section 3. Minimum Compensation Components. Minimum Compensation shall consist of each of the following:

(a)(i) Hourly gross compensation in the amount of nine dollars (\$9.00) per hour.

(ii) On January 1, 2002, the Agency shall increase the hourly gross compensation to ten dollars (\$10.00) per hour; provided, however, that in the case that an increase in the gross compensation under the City's Minimum Compensation Ordinance

does not take effect on January 1, 2002, the Agency's increase shall become effective on the later date imposed by the City ordinance; provided, further, however, that in the case of Nonprofit Corporations, the Agency may approve this adjustment only upon the Executive Director's review of the Joint Report issued by the Controller, Mayor's Budget Office, and Budget Analyst, pursuant to the City's ordinance and finds that the Agency has sufficient funds to pay the anticipated costs of the adjustment. A finding of "sufficient funds" shall mean that the Agency will not be required to reduce services in order to pay the anticipated costs of the adjustment.

(iii) For each of the next three (3) years after the adjustment provided in Section 3.1(a)(ii) is made, at annual intervals, the Agency shall make an additional adjustment of two and one-half percent (2.5%).

(b) Compensated time off (at the compensation rates specified in Section 3.1(a)) in an hourly amount that, on an annualized basis for a full-time employee, equals twelve (12) days per year. Such time off shall vest with the Covered Employee at the end of the applicable Pay Period and may be used, for sick leave, vacation or personal necessity. Notwithstanding the foregoing, if a Contractor reasonably determines, in good faith, that the Contractor cannot comply with this requirement for compensated time off, the Contractor shall provide the Covered Employee with a cash equivalent of such compensated time off.

(c) Uncompensated time off in an hourly amount that, on an annualized basis for a full-time employee, equals ten (10) days per year. Such time off shall vest with the Covered Employee at the end of the applicable Pay Period and may be used, at the option of the Covered Employee, for sick leave for the illness of the Covered Employee or such Covered Employee's spouse, domestic partner, child, parent, sibling, grandparent or grandchild.

Section 4. Contract Requirements. Every Contract or Contract Amendment entered into on or after the Effective Date shall provide as follows:

4.1 For each hour worked by a Covered Employee during each Pay Period during the term of the Contract (as such term may be extended from time to time), Contractor shall provide to such Covered Employee no less than the Minimum Compensation as required in this Policy.

4.2 Failure to comply with the foregoing requirement shall constitute a material breach by Contractor of the terms of the Contract. Such failure shall be determined by the Agency in its sole discretion.

4.3 If, within thirty (30) days after the Contractor receives written notice of such a breach, Contractor fails to cure such breach or, if such breach cannot reasonably be cured within such period of thirty (30) days, Contractor fails to commence efforts to cure within such period, or thereafter fails diligently to pursue such cure to completion, the Agency shall have the right to pursue any rights or remedies available under the terms of the Contract or under applicable law.

4.4 The Contractor shall not discharge, reduce in compensation, or otherwise discriminate against any Employee for complaining to the Agency with regard to the employer's compliance or anticipated compliance with this Policy, for opposing any practice proscribed by this Policy, for participating in proceedings related to this Policy, or for seeking to assert or enforce any rights under this Policy by any lawful means.

4.5 The Contractor represents and warrants that it is not an entity that was set up, or is being used, for the purpose of evading the intent of this Policy.

4.6 The Contractor shall keep itself informed of the current Minimum Compensation, and shall provide prompt written notice to all Covered Employees of annual adjustments to the Minimum Compensation, as well as any written communications received by the Contractor from the Agency, which communications are marked to indicate that they are to be distributed to Covered Employees.

4.7 The Contractor shall provide reports to the Agency in accordance with any reporting standards promulgated by the Agency's Contract Compliance Division.

4.8 The Contractor shall provide the Agency with access to pertinent records after receiving a written request to do so and being provided at least five (5) Business Days to respond.

4.9 The Contract Compliance Division may conduct random audits of Contractors. Random audits shall be (i) noticed in advance in writing; (ii) limited to ascertaining whether Covered Employees are paid at least the minimum compensation required by this Policy; (iii) accomplished through an examination of pertinent records at a mutually agreed upon time and location within ten (10) Business Days of the written notice; and (iv) limited to one (1) audit per Contractor every two (2) years for the duration of the Contract. Nothing in this Section shall be deemed to interfere with the authority of the Contract Compliance Division to investigate any report of an alleged breach of contract as provided in Section 6.2.

4.10 Any Contractor subject to the provisions of this Policy shall promptly notify the Contract Compliance Division of any subcontractors performing services covered by this Policy and shall certify to the Contract Compliance Division that it has notified the subcontractors of their obligations under this Policy.

Section 5. Administration and Enforcement.

5.1 The Contract Compliance Division shall adopt the guidelines or rules adopted by the City and County of San Francisco for implementation of the City's Minimum Compensation Ordinance. At the option of the Contract Compliance Division, additional or revised guidelines or rules for the administration of this Policy may be adopted to facilitate the Agency's implementation of this Policy. Such guidelines and rules shall not be adopted finally until the Contract Compliance Division has held at least one (1) public community meeting and a workshop at a regularly scheduled Agency Commission meeting on the proposed guidelines. The guidelines and rules shall establish procedures for providing administrative hearings requested by Covered Employees to

determine whether a Contractor has breached a Contract based on the Minimum Compensation requirements of this Policy. The guidelines and rules shall also establish procedures permitting Contractors to provide payroll information in confidence to the Agency for purposes of monitoring compliance under this Policy and authorizing disclosure of the information by the Agency only when necessary for enforcement purposes. The Contract Compliance Division shall also issue a determination as to whether a particular instrument constitutes a Contract or agreement subject to the requirements of this Policy. The Contract Compliance Division shall report annually on compliance with this Policy to the Agency Commission. Such report shall include cumulative information regarding the number of waivers granted by the Executive Director or Agency Commission pursuant to Sections 6, 7, 8 and 9 of this Policy and statistical data regarding such waivers.

5.2 A Covered Employee may report to the Contract Compliance Division in writing any alleged breach by a Contractor of the terms required to be contained in the applicable Contract under this Policy. The Contract Compliance Division shall investigate any such report. If the Contract Compliance Division determines that a Contractor is in breach of any such term, the Contract Compliance Division shall notify the Executive Director of its findings and of any action that the Contract Compliance Division requests that the Executive Director take with respect to such breach. In order to ensure compliance with this Policy and to enhance the monitoring activities of the Contract Compliance Division, the Agency desires to encourage reporting by Covered Employees pursuant to this subsection. The Contract Compliance Division shall keep confidential, to the maximum extent permitted by applicable laws, the Covered Employee's name and other identifying information.

5.3 In addition to any other rights or remedies available to the Agency under the terms of the Contract or under applicable law, the Agency shall have the following rights, in the event of such failure by the Contractor:

(a) the right to charge the Contractor an amount equal to the difference between the Minimum Compensation levels required by this Policy and any compensation actually provided to each Covered Employee who was not paid in accordance with the terms of this Policy, together with interest on such amount from the date payment was due at the maximum rate then permitted by law;

(b) the right to set off all or any portion of the amount described in Section 5.3(a) against amounts due to Contractor under the Contract;

(c) the right to terminate the Contract in whole or in part;

(d) in the event of a breach by Contractor of the covenant referred to in Section 4.4, the right to seek reinstatement of the affected Covered Employee or to obtain other appropriate equitable relief; and

(e) the right to bar a Contractor from entering into future contracts with the Agency for three (3) years. Each of these rights shall be exercisable individually or in

combination with any other rights or remedies available to the Agency. Any amounts realized by the Agency pursuant to this subsection shall be paid to each applicable Covered Employee.

5.4 Each Covered Employee shall be a third-party beneficiary under the Contract as set forth in this Section 5.4 and in Section 5.5, and may pursue the following remedies in the event of a breach by the Contractor of any contractual covenant described in Section 3 or Section 4, but only after the Covered Employee has provided the notice and participated in the administrative review hearing provided in this Section 5.4. The Covered Employee shall give written notice of a breach to the Contractor and to the Contract Compliance Division. If the Contract Compliance Division determines that no breach has occurred, or if the Agency fails to obtain the cure of a breach by the Contractor within sixty (60) days after receipt of notice by the Covered Employee, the Covered Employee may request an administrative review hearing. The Covered Employee must request such a hearing within ninety (90) days after giving written notice of the breach. Unless the Covered Employee withdraws the request for a hearing, the Contract Compliance Division shall conduct, or arrange to have conducted, a hearing. The Employee shall have the right to attend the hearing personally or through a designated representative. The Contract Compliance Division shall notify the Contractor of the hearing so that the Contractor may attend and present evidence. After the hearing is completed, the person conducting the hearing shall determine whether the Contractor has breached the Contract. Upon the issuance of a written decision finding a breach, and after a waiting period of twenty-one (21) days, the Covered Employee may bring an action against the Contractor for such breach in the Superior Court of the State of California, as appropriate, unless the Agency has commenced an action against the Contractor based on the breach, or obtained compliance, within the twenty-one (21)-day waiting period and provided notice to the Covered Employee of that action. If the Covered Employee prevails in such action, the Covered Employee may be awarded: (A) an amount equal to the difference between the Minimum Compensation and any compensation actually provided to the Covered Employee, together with interest on such amount from the date payment was due at the maximum rate then permitted by law; and (B) in the event of a breach by Contractor of the covenant referred to in Section 4.4, the right to seek reinstatement or to obtain other appropriate equitable relief.

5.5 In the event of any legal action or proceeding between Contractor and a Covered Employee arising from this Attachment 15, the unsuccessful party to such action or proceeding shall pay to the prevailing party all costs and expenses, including reasonable attorney's fees and disbursements, incurred by such prevailing party in such action or proceeding and in any appeal in connection with such action or proceeding; provided, however, that a Contractor shall be entitled to such costs and expenses only if the court determines that the Covered Employee's action or proceeding was frivolous, vexatious or otherwise an act of bad faith. If such prevailing party recovers a judgment in any such action, proceeding or appeal, such costs, expenses and attorneys' fees and disbursements shall be included in and as a part of such judgment. This Attachment 15 does not authorize any award of costs, expenses, or attorney's fees in favor of or against the Agency.

5.6 The Agency shall maintain the confidentiality of payroll information obtained in the course of monitoring compliance with this Policy and shall disclose such information only as necessary for enforcement purposes.

5.7 The Contract Compliance Division shall develop a procedure for obtaining an assurance from Contractors when they sign an agreement subject to this Policy that they comply with the requirements of this Policy, such as the signing of an affidavit of compliance.

Section 6. Waivers. The Executive Director shall waive the requirements of this Policy under the following circumstances:

6.1 The Executive Director has determined that (a) either (1) there is only one prospective Contractor willing to enter into the applicable Contract on the terms and conditions established by the Agency (other than the requirements of this Policy); or (2) the needed services under the applicable Services Contract are available only from a sole source; and (b) the prospective Contractor is not currently disqualified from doing business with the Agency or any other governmental agency.

6.2 The Executive Director has determined in writing that the Contract is necessary to respond to an emergency which endangers the public health or safety and no entity that complies with the requirements of this Policy and is capable of responding to the emergency is immediately available to perform the required services.

6.3 The Executive Director has determined in writing that (a) there are no qualified responsive bidders or prospective vendors that comply with the requirements of this Policy; and (b) the Contract is for a service, project, or property that is essential to the Agency or the public.

6.4 the Executive Director has determined in writing that (a) the Services to be purchased are available under a bulk purchasing arrangement with a federal, state or local governmental entity; (b) purchase under such arrangement will substantially reduce the Agency's cost of purchasing such Services; and (c) purchase under such an arrangement is in the best interest of the Agency or the public.

Section 7. Additional Waivers by the Executive Director – Nonprofit Corporations. A Nonprofit Corporation may seek a waiver from the requirements of the adjustments provided in Section 3.1(b) and Section 3.1(c) if the highest paid managerial position in the organization earns a salary which, when calculated on an hourly basis, is not more than six (6) times the lowest wage paid by the organization to a Covered Employee. The Nonprofit Corporation shall provide to the Contracting Department a written statement, prepared and signed by the Nonprofit Corporation, setting forth an explanation of the economic hardship to the Nonprofit Corporation or the negative impact on services that would result from compliance with this Policy. The Executive Director may grant the requested waiver. Each waiver shall be effective for a period of up to one (1) year, and subsequent waivers may be requested and granted.

Section 8. Special Waiver By the Agency Commission. A special waiver may be

granted if, upon receipt of an application from the Contractor, stating fully the grounds of the request and the facts pertaining thereto, the Agency finds following its own further investigation that the application of the Policy would result in an adverse impact on services or an unreasonable financial impact on the Contract. In order to permit any such waiver, the Agency must determine that:

(a) The application of the Policy would result in practical difficulties or unnecessary hardships inconsistent with the general purpose and intent of the applicable Redevelopment Plan;

(b) There are exceptional circumstances or conditions applicable to the property, the intended development of the property, or the services proposed through a contract, which do not apply generally to other properties or contracts having the same standards, restrictions and controls;

(c) Permitting a waiver, for a specified period of time, will not be materially detrimental to the public welfare or injurious to property or improvement in the area; and,

(d) Permitting a waiver, for a specified period of time, will not be contrary to the objectives of the applicable redevelopment plan.

Waivers shall only be granted for a limited time period as determined to be needed to promote the general purpose and intent of the applicable redevelopment plan. Subsequent waivers may be requested and either granted or denied. The Agency anticipates that all covered Projects and Contracts will eventually transition to achieving a viability that will allow for covered Contractors to comply with the Policy.

Section 9. Waiver Through Collective Bargaining. All or any portion of the applicable requirements of this Policy may be waived in a bona fide collective bargaining agreement, provided that such waiver is explicitly set forth in such agreement in clear and unambiguous terms.

Section 10. Relationship to Other Requirements. This Policy provides a minimum level of compensation and shall not be construed to preempt or otherwise affect any other law, regulation or requirement providing a higher level of compensation.

Section 11. Preemption. Nothing in this Policy shall be interpreted or applied so as to create any power or duty in conflict with any federal or state law.

Section 12. Effective Date. This Policy shall become effective the date of the Agency approval.

Section 13. Severability. If any part or provision of this Policy, or the application of this Policy to any person or circumstance, is held invalid, the remainder of this Policy, including the application of such part or provisions to other persons or circumstances, shall not be affected by such a holding and shall continue in full force and effect. To this end, the provisions of this Policy are severable.

ATTACHMENT 16

HEALTH CARE ACCOUNTABILITY POLICY

This Health Care Accountability Policy (the "Policy") is attached to and made a part of the Disposition and Development Agreement (the "Agreement") for Hunters Point, Phase 1 ("Phase 1"). Terms not defined in this Attachment have the meanings given to them in the Agreement. Developer is bound by this Attachment as part of the obligations it assumes and benefits it receives under the Agreement.

Section 1. Findings and Declarations.

1.1 The San Francisco Redevelopment Agency of the City and County of San Francisco (the "Agency") enters into many contracts, including, without limitation, service contracts, loan and grant agreements and property agreements, in furtherance of the objectives of the California Community Redevelopment Law (Health and Safety Code §§ 33000 *et seq.*) in the interest of the health, safety and general welfare of the City of San Francisco's (the "City") residents.

1.2 These contracts and agreements have at times involved compensation to the contracting parties' or their subcontractors' employees that does not include health benefits or does not provide a high enough level of compensation that would allow an employee to acquire their own health insurance. Uninsured persons seeking medical assistance place an immediate burden on the City's limited public health resources and place the uninsured at a far greater level of health risk. Requiring these contracting parties and their subcontractors to offer health benefits to their employees, or to make payments to the City's Department of Public Health to provide for the care of such persons, or to participate in a health benefits program developed by the City's Director of Health, will improve the health, safety and general welfare of San Francisco's residents by ensuring health benefits for many more of the City's residents who are now uninsured.

Section 2. Definitions.

Agency means the Redevelopment Agency of the City and County of San Francisco.

Agency Property means real property that is owned by the Agency or over which the Agency has exclusive use. "Exclusive use" means the right to use or occupy real property to the exclusion of all others, subject to the rights reserved by the party granting such exclusive use.

Agreement has the meaning set forth in the Preamble.

Business Day means a day other than Saturday, Sunday or a bank, City, or Agency holiday.

City means the City and County of San Francisco.

Contract means an agreement or portion of an agreement that provides for services to be purchased at the expense of the Agency or out of funds established by ordinance or Memorandum of Understanding (MOU), or otherwise controlled by the Agency. The term Contract includes, without limitation, Property Agreements, Subcontracts and agreements such as grant agreements, pursuant to which agreements the Agency grants funds to a Contractor for services (including, without limitation, cultural activities, performances or exhibitions) to be rendered to all or any portion of the public rather than to Agency. Notwithstanding the foregoing, the term Contract excludes:

- (a) Agreements for a duration of less than one (1) year. Contractors are prohibited from entering into multiple contracts of short duration in order to evade the requirements of this Policy;
- (b) Agreements for the purchase or lease of goods, or for guarantees, warranties, shipping, delivery, installation or maintenance of such goods. Where an agreement is for the purchase or lease of both goods and other services, the agreement shall not be deemed a Contract if a preponderance of the contract amount is for goods;
- (c) Agreements entered into pursuant to settlement of legal proceedings;
- (d) Agreements for urgent or specialized advice, consultation or litigation services for the Agency where the General Counsel finds that it would be in the best interests of the Agency not to include the requirements of this Policy;
- (e) Agreements with any person or entity if the amount of the agreement is less than twenty-five thousand dollars (\$25,000.00) (in the case of a for-profit entity or person) or less than fifty thousand dollars (\$50,000.00) (in the case of a Nonprofit Corporation). However, if the Contracting Party has multiple agreements with the Agency in a given fiscal year (which agreements would be considered Contracts under this Policy except that the individual dollar amounts are below the thresholds set forth in the preceding sentence) and the cumulative amount of such agreements is seventy-five thousand dollars (\$75,000.00) or more, the provisions of this Policy shall apply to each such agreement from the date on which the triggering Contract is executed;
- (f) Agreements for the investment, management or use of trust assets where compliance would violate the fiduciary duties of the trustee;
- (g) Agreements executed prior to the Effective Date (unless and until a Contract Amendment is executed);
- (h) Agreements executed after the Effective Date (unless and until a Contract Amendment is entered into) pursuant to, and within the scope of, bid packages or requests for proposals advertised and made available to the

public prior to the Effective Date, unless the bid packages or requests for proposals are materially amended on or after the Effective Date;

- (i) Agreements that require the expenditure of grant funds awarded to the Agency by another entity. If a Contract is funded both by grant funds and non-grant funds, the entire Contract is exempt; provided that, if the use of the grant funds is severable from the non-grant funds, the Contract is exempt only with respect to the use of the grant funds;
- (j) Agreements pursuant to which the Agency awards a grant to a Nonprofit Corporation;
- (k) Agreements with a public entity;
- (l) Agreements for employee benefits to be provided to Agency employees, where the Agency Executive Director finds that no person or entity is willing to comply with this Policy and is capable of providing the required employee benefits;
- (m) Agreements for the investment, management or use of Agency monies where the Agency Executive Director finds that requiring compliance with this Policy will violate the Agency's fiduciary duties and agreements for the investment of retirement, health or other funds held in trust pursuant to Charter, statute, ordinance or MOU where the official or officials responsible for investing or managing such funds find that requiring compliance with this Policy will violate their fiduciary duties;
- (n) Loan agreements and agreements made in connection with loans or grants under which the Agency, as creditor or grantor, is providing funds to be used by the debtor or grantee to:
 - (1) Acquire an interest in real property on which residential improvements for low- or moderate-income households will be constructed;
 - (2) Construct improvements owned or leased by the debtor or grantee, on condition that residents of the improvements qualify as low-or-moderate-income households; or
 - (3) Rehabilitate improvements owned or leased by the debtor or grantee;
- (o) Disposition and development or ground lease agreements of Agency Property on which residential improvements for low-or-moderate income households will be constructed or existing improvements will be operated for low-or-moderate income households; provided, however, that any leases for commercial space in such properties shall be considered Included Leases and shall be subject to the requirements of this Policy;

- (p) Agreements between a Tenant or Subtenant and a Contractor to perform services on property covered by a Lease if the Contractor does not provide such services on a regular and on-going basis. For purposes of this exemption, if employees of the Contractor and any Subcontractors cumulatively work on the Lease property less than one hundred and thirty (130) days within a twelve (12) month period, the agreement shall not be considered regular and on-going.
- (q) Agreements with an owner (such as owner participation agreements) where such agreement is granted in the exercise of the Agency's regulatory or police powers.

Contract Amendment means a modification to an agreement which extends the term, increases the total amount of payments due from the Agency (except where such increase is due solely to cost of living adjustments), or modifies the scope of services to be performed by the Contractor; provided that the resulting agreement falls within the definition of Contract.

Notwithstanding the foregoing, the term Contract Amendment does not include a one-time extension of the term of a Contract for up to six (6) months, or a construction change order, modification or amendment to a Contract executed by the Agency for its benefit (as determined by the Agency Executive Director).

Contracting Party means a Contractor who enters into a Contract.

Contractor means the person or entity that enters into a Contract with the Agency. The term Contractor also means any person or entity that enters into a Contract with a Tenant or Subtenant to perform services on property covered by a Lease.

Covered Employee means:

- (a) An Employee of a Contractor or Subcontractor who works on an Agency Contract or Subcontract for fifteen (15) hours or more per Week, (1) Within the geographic boundaries of the City of San Francisco; or (2) Elsewhere in the United States.
- (b) An Employee of a Tenant or Subtenant who works fifteen (15) hours or more per Week on property that is covered by a Lease or Sublease; and
- (c) An Employee of a Contractor or Subcontractor that has a Contract or Subcontract to perform services on property covered by a Lease or Sublease if the Employee works fifteen (15) hours or more per Week on the property.

Notwithstanding the foregoing, the term Covered Employee does not include the following:

- (1) Any Employee under the age of eighteen (18) who is a student, provided that the Employee does not replace, displace or lower the wage or benefits of any existing position or Employee; or
- (2) Any Employee employed as a trainee in a bona fide training program consistent with federal law, which training program enables the Employee to advance into a permanent position, provided that the Employee does not replace, displace or lower the wage or benefits of any existing position or Employee; or
- (3) Any Employee that the Contracting Party is required to pay no less than the "prevailing rate of wage" in accordance with the Agency's Prevailing Wage Policy; or
- (4) Any disabled Employee who:
 - (A) Is covered by a current sub-minimum wage certificate issued to the employer by the U.S. Department of Labor; or
 - (B) Would be covered by such a certificate but for the fact that the employer is paying a wage equal to or higher than the minimum wage.

Effective Date means the date the Agency Commission approves this Policy.

Employee means any person who is employed by a Contractor, including part-time and temporary employees.

Included Lease means a lease, sublease or other agreement with any person or entity for the exclusive right to occupy or use all or any portion of real property owned, leased or otherwise controlled by the Agency in which the Agency has a Proprietary Interest.

Lease means a written agreement (including, without limitation, any lease, concession or license) in which:

- (a) the Agency gives to another party the exclusive use of Agency Property for a term exceeding one (1) year, whether by single or cumulative instruments. If cumulative instruments cause the term of the agreement to exceed one (1) year, the agreement shall be subject to this Policy only on or after the effective date of the instrument which causes the term to exceed one (1) year. The term Lease includes Lease Amendment.
- (b) the Contractor gives to another party the exclusive use of property in which the Agency has a Proprietary Interest for a term exceeding one (1) year, whether by single or cumulative instruments. If cumulative instruments cause the term of the agreement to exceed one (1) year, the

agreement shall be subject to this Policy only on or after the effective date of the instrument which causes the term to exceed one (1) year.

Lease Amendment means a modification to a Lease that extends the term or materially changes any other provision of the Lease. Notwithstanding the foregoing, the term Lease Amendment does not include a one-time extension of the term of a Lease for up to six (6) months, or relocation of the leased premises at the request of the Agency for its benefit or convenience (as determined by the Agency Executive Director).

Nonprofit Corporation means a nonprofit corporation, duly organized, validly existing and in good standing under the laws of the jurisdiction of its incorporation and (if a foreign corporation) in good standing under the laws of the State of California, which corporation has established and maintains valid nonprofit status under Section 501(c)(3) of the United States Internal Revenue Code of 1986, as amended, and all rules and regulations promulgated under such Section.

Policy has the meaning set forth in the Preamble.

Property Agreements means Disposition and Development Agreements (DDAs), ground leases, and any other agreements with the Agency (other than Excluded Subcontracts) in which the Agency has a Proprietary Interest.

Proprietary Interest means any nonregulatory arrangement or circumstance in which the financial or other nonregulatory interests of the Agency in a Contract could be adversely affected, in the following circumstances:

- (a) The Agency receives significant ongoing revenue (such as rent payments) under a lease or ground lease of real property owned by the Agency for the development of a project pursuant to a Contract, excluding government fees or tax or assessment revenues, or the like (except for tax revenues under the circumstances specified in (b) below); or
- (b) The Agency receives ongoing revenue from a project pursuant to a Contract to pay debt service on bonds or loans provided by the Agency to assist the development of such project (including incremental tax revenues generated by the project or the development project in which it is located and used), directly or indirectly, to pay debt service on bonds or to repay a loan by the Agency where the proceeds are used for development of that project or the development project in which it is located;
- (c) The Agency has agreed in a Contract to underwrite or guarantee the development or operation of a development project, or loans related thereto;
- (d) The Agency pursuant to a Contract receives a continuing financial payment that is specific to that project, which is not a tax or other charge of general applicability or a one-time payment for the land;

- (e) The Agency receives a share in the profits of a project in a negotiated economic participation agreement pursuant to a Contract;
- (f) In addition to the circumstances described above, the Agency shall be deemed to have a Proprietary Interest in a Contract for a project if the Agency determines or an interested party demonstrates, prior to the effective date of the Contract pursuant to which a project will be operated, that there is a significant risk that the Agency' financial or other nonregulatory interest in the project could be adversely affected, except that no circumstance or arrangement shall be considered "financial or non-regulatory" under this definition if it arises from the exercise of regulatory or police powers such as taxation or the receipt of tax increment funds as provided in Article 16, section 16 of the California Constitution (except as provided in (b) above), zoning or the issuance of regulatory permits.

Subcontract means an agreement between a Contractor and a person or entity pursuant to which the person or entity agrees to perform all or a portion of the services covered by a Contract. Notwithstanding the foregoing, the term Subcontract does not include:

- (a) Agreements for the purchase or lease of goods, or for guarantees, warranties, shipping, delivery, installation or maintenance of such goods. When an agreement is for the purchase or lease of both goods and other services, the agreement shall not be deemed a Subcontract if a preponderance of the Contract amount is for goods; or
- (b) Agreements with a public entity.

Subcontractor means a person or entity that enters into a Subcontract.

Sublease means any agreement with any person or entity for the exclusive right to occupy or use all or any portion of City Property covered by a Lease or Property Agreement. Notwithstanding the foregoing, the term Sublease does not include each of the circumstances that constitutes an exclusion from the definition of Lease or Property Agreement.

Subtenant means a person or entity that enters into a Sublease.

Tenant means the person or entity that enters into a Lease or Property Agreement with the City.

Week shall mean a consecutive seven (7)-day period. If the Contractor's regular pay period is other than a seven (7)-day period, the number of hours worked by an employee during a seven (7)-day Week, for purposes of this Policy, shall be calculated by adjusting the number of hours actually worked during the Contractor's regular pay period to determine the average over a seven (7)-day Week. However, such period of averaging shall not exceed a duration of one (1) month.

Section 3. Health Care Accountability Components.

3.1 With respect to each Covered Employee who either resides in San Francisco (regardless of where the Covered Employee provides services) or provides services covered by this Policy in San Francisco, each Contractor shall do one of the following, at the Contractor's option:

(a) Offer to the Covered Employee health plan benefits that meet minimum standards prepared by the City's Health Director and approved by the City's Health Commission. The minimum standards shall provide for a maximum period for each Covered Employee's health benefits to become effective, not to exceed thirty (30) days from the start of employment on a covered Contract, Subcontract, Lease or Sublease. The Health Commission shall review such standards every two (2) years to ensure that the standards stay current with State and Federal regulations and existing health benefits practices; or

(b) For each Week in which the Covered Employee works the applicable minimum number of hours set forth in the definition of Covered Employee), pay to the City one dollar and fifty cents (\$1.50) [**check current rate**] per hour for each hour the Covered Employee is employed by the Contracting Party on the Contract or Subcontract or on property covered by a Lease, but not to exceed sixty dollars (\$60.00) [**check current rate**] in any Week. The City shall appropriate money received pursuant to this Section 3.1(b) for the use of the Department of Public Health. The Department of Public Health shall use the monies appropriated for staffing and other resources to provide medical care for the uninsured. The Health Commission may increase this hourly rate and Weekly maximum in accordance with the Bureau of Labor Statistics Consumer Price Index for Medical Care in the San Francisco Bay Area or such other factors as the Health Commission finds appropriate; provided, however, the Health Commission shall take this action no more than once a year and any adjustments in such hourly rate or Weekly maximum must be approved by the Board of Supervisors by resolution; or

(c) Participate in a health benefits program developed by the Health Director in consultation with the City's Purchasing Department. The Health Director shall obtain Health Commission approval of the program before implementing it. The Health Director shall seek such approval within twelve (12) months after this Policy is finally approved. Prior to implementation of the health benefits program provided in this Section 3.1(c), each Contractor shall comply with Section 3.1(a) or 3.1(b). After the Health Director implements the program, in addition to the options provided in Sections 3.1(a) and 3.1(b), Contractors may satisfy their obligations under this Policy by complying with the requirements of the health benefits program. In developing the program, the Health Director shall (i) attempt to make health coverage available for uninsured Covered Employees and, if feasible, other uninsured City residents; (ii) use public health facilities to the maximum extent practicable; (iii) make the program economically viable; and (iv) provide a mechanism for funding which relies, as much as possible, on contributions by participating employers and employees.

3.2 With respect to each Covered Employee who does not reside in San Francisco, but who provides services covered by this Policy, each Contractor shall do one of the options set forth in Section 3.1, at the Contractor's option.

3.3 With respect to each Covered Employee who does not reside in San Francisco, and does not provide services covered by this Policy in San Francisco, each Contractor shall do one of the following, at the Contractor's option:

(a) Offer to the Covered Employee health plan benefits that meet minimum standards prepared by the Health Director and approved by the Health Commission pursuant to Section 3.1(a) above; or

(b) For each Week in which the Covered Employee works the applicable minimum number of hours set forth in the definition of Covered Employee), pay to the Covered Employee an additional one dollar and fifty cents (\$1.50) [**check current rate**] per hour for each hour the Covered Employee is employed by the Contracting Party on the Contract or Subcontract or on property covered by a Lease, but not to exceed sixty dollars (\$60.00) [**check current rate**] in any Week, to enable the employee to obtain health insurance coverage. This represents the City's current estimate of the average cost of obtaining individual health insurance benefits. The Health Commission may increase this hourly rate and Weekly maximum in accordance with the Bureau of Labor Statistics Consumer Price Index for Medical Care in the San Francisco Bay Area or such other factors as the Health Commission finds appropriate in order to track the cost of obtaining individual health insurance; provided, however, the Health Commission shall take this action no more than once a year and any adjustments in such hourly rate or Weekly maximum must be approved by the City's Board of Supervisors by resolution.

3.4 Notwithstanding the above, if, at the time a Contract, Subcontract, Lease, or Sublease is executed, the Contractor has twenty (20) or fewer employees (or, in the case of a Nonprofit Corporation, fifty (50) or fewer employees), including any employees the Contractor plans to hire to implement the Contract, Subcontract, Lease or Sublease, the Contractor shall not be obligated to provide the Health Care Accountability Components set forth in this Section 3 to its Covered Employees. In determining the number of employees a Contractor has, all employees of all entities that own or control the Contractor and that the Contractor owns or controls, shall be included.

Section 4. Contractual Obligations.

4.1 Each Contractor that enters into a Contract, Subcontract, Lease, or Sublease shall agree:

(a) To comply with the requirements of this Policy, including the requirement to choose and perform one of the Health Care Accountability Components set forth in Section 3;

(b) To comply with regulations adopted by the Agency pursuant to this Policy;

(c) To provide information and reports to the Agency in accordance with any reporting standards promulgated by the Agency in consultation with the City's Director of Health;

(d) To provide the Agency with access to pertinent records relating to the number of employees employed and terms of medical coverage as allowed by law after receiving a written request to do so and being provided at least five (5) Business Days to respond;

(e) To cooperate with the Agency when it conducts audits;

(f) To include in every Contract, Subcontract, Lease, or Sublease subject to this Policy provisions requiring compliance with this Policy, consistent with any directives or standards adopted by the Agency;

(g) To notify the Agency promptly of any Subcontractors performing services covered by this Policy and certify to the Agency that it has notified the Subcontractors of their obligations under this Policy; and

(h) To represent and warrant that it is not an entity that was set up, or is being used, for the purpose of evading the intent of this Policy.

4.2 A Contractor shall not discharge, reduce in compensation, or otherwise discriminate against any Employee for notifying the City regarding the Contractor's noncompliance or anticipated noncompliance with this Policy, for opposing any practice proscribed by this Policy, for participating in proceedings related to this Policy, or for seeking to assert or enforce any rights under this Policy by any lawful means.

Section 5. Administration and Enforcement.

5.1 The Agency shall implement the City's Department of Public Health regulations for the interpretation and administration of this Policy, to the extent such regulations are consistent with adopted Agency Policy.

5.2 The Agency's General Counsel shall develop contractual provisions for use by Agency staff designed to enable the Agency to pursue the remedies set forth in this Section against every person or entity required to comply with this Policy.

5.3 The Agency, or at its request, the City's Department of Public Health, may conduct audits of Contractors, although such audits shall be conducted only with at least ten (10) Business Days' advance written notice to the Contractor and after making good faith efforts for a mutually agreed upon time and location.

5.4 The Agency's Contract Compliance Division shall provide an annual joint report to the Agency Commission on compliance with this Policy. Such report shall include cumulative information regarding the number of waivers granted pursuant to this Policy.

5.5 A Covered Employee may report in writing to the Agency's Contract Compliance Division any alleged violation of this Policy by a Contractor or other person or entity subject to this Policy. The Agency shall investigate any such report. If the Agency determines that any person or entity has violated this Policy, the Agency shall notify the Contractor of its findings. In order to ensure compliance with this Policy and to enhance the monitoring activities of the Agency, the Agency encourages reporting by Covered Employees pursuant to this Section 5.5. The Agency shall keep confidential the Covered Employee's name and other identifying information, to the maximum extent permitted by applicable law.

5.6 The Agency has the right to assign the enforcement provisions of this section, including Sections 5.3, 5.7, 5.8(a), 5.8(b), 5.8(c) and 5.9 to the appropriate City department to act on behalf of the Agency;

5.7 In addition to any other rights or remedies available to the Agency under the terms of any agreement of a Contractor or under applicable law, the Agency, or the City acting on behalf of the Agency, shall have the following rights:

(a) The right to charge the Contractor for any amounts that the Contractor should have paid to the City for hours worked by Covered Employees pursuant to Sections 3.1(b) and 3.2, together with interest on such amount from the date payment was due at the maximum rate then permitted by law;

(b) The right to assess liquidated damages of fifty dollars (\$50.00) [**check current rate**] a day for each Covered Employee each day that the Contractor fails to pay to the City the amounts required by Sections 3.1(b) and 3.2;

(c) The right to set off all or any portion of the amount that a Contractor is required to pay to the City pursuant to preceding Sections 5.7(a) and (b) against amounts due to a Contractor;

(d) The right to terminate the Contract or Lease in whole or in part;

(e) The right to bar a Contractor from entering into future Contracts or Leases with the Agency for three (3) years.

5.8 Each Contractor shall be responsible for its Subcontractors with respect to compliance with this Policy. If a Subcontractor fails to comply, the Agency, or the City acting on behalf of the Agency, may pursue the remedies set forth in this Section 5 against the Contractor based on the Subcontractor's failure to comply, provided that the Agency has first provided the Contractor with notice and an opportunity to obtain a cure of the violation.

5.9 Each Tenant shall be responsible for each Subtenant, Contractor and Subcontractor performing services on property covered by the Tenant's Lease, with respect to compliance with this Policy. If any Subtenant, Contractor or Subcontractor fails to comply, the Agency, or the City acting on behalf of the Agency, may pursue the remedies set forth in this Section 5 against the Tenant based on the Subtenant's, Contractor's or Subcontractor's failure to comply, provided that the Agency has first provided the Tenant with notice and an opportunity to obtain a cure of the violation.

5.10 Each of the rights set forth in this Section 5 shall be exercisable individually or in combination with any other rights or remedies available to the Agency. Any amounts realized by the Agency pursuant to this Section 5 shall be used first to cover the costs of enforcing this Policy and thereafter appropriated for the use of the Department of Public Health.

Section 6. Waivers by the Agency Executive Director.

6.1 The Agency Executive Director or designee shall waive the requirements of this Policy when the relevant Agency staff has provided justification to the Agency Executive Director, and the Agency Executive Director has found that one of the following circumstances exists:

(a) There is only one prospective Contractor or Tenant willing to enter into the applicable Contract or Lease on the terms and conditions established by the Agency (other than the requirements of this Policy);

(b) The needed service, project or property arrangement under the Contract or Lease is available only from a sole source;

(c) The Contract or Lease is necessary to respond to an emergency that endangers the public health or safety;

(d) There are no qualified responsive bidders or prospective vendors or tenants that comply with the requirements of this Policy and the agreement is for a service, lease or project that is essential to the Agency, City or the public;

(e) The public interest warrants the granting of a waiver because application of this Policy would constitute an adverse impact on services or an unreasonable adverse financial impact on the Agency or City; or

(f) The services to be purchased are available under a bulk purchasing arrangement with a federal, state or local governmental entity;

(g) Purchase under such arrangement will substantially reduce the Agency's cost of purchasing such services; and

(h) Purchase under such an arrangement is in the best interest of the Agency or the public.

6.2 Each waiver shall be effective for the duration of the Contract or Lease. Subsequent waivers may be requested and either granted or denied.

Section 7. Special Waiver by the Agency Commission.

A special waiver is available if, upon receipt of an application from the Contractor, stating fully the grounds of the request and the facts pertaining thereto, the Agency finds following its own further investigation that the application of the Policy would result in an adverse impact on services or an unreasonable financial impact on the Contract. In order to permit any such waiver, the Agency must determine that:

7.1 The application of the Policy would result in practical difficulties or unnecessary hardships inconsistent with the general purpose and intent of the applicable Redevelopment Plan;

7.2 There are exceptional circumstances or conditions applicable to the property, the intended development of the property, or the services proposed through a contract, which do not apply generally to other properties or contracts having the same standards, restrictions and controls;

7.3 Permitting a waiver, for a specified period of time, will not be materially detrimental to the public welfare or injurious to property or improvement in the area; and,

7.4 Permitting a waiver, for a specified period of time, will not be contrary to the objectives of the applicable redevelopment plan.

Waivers shall only be granted for a limited time period as determined to be needed to promote the general purpose and intent of the applicable redevelopment plan. Subsequent waivers may be requested and either granted or denied. The Agency anticipates the all covered Projects and Contracts will eventually transition to achieving a viability that will allow for covered Contractors to comply with the Policy.

Section 8. Preemption.

Nothing in this Policy shall be interpreted or applied so as to create any power or duty in conflict with any federal or state law.

Section 9. Effective Date.

This Policy shall become effective on the date of Agency Commission approval.

Section 10. Period of Suspension.

Contractors shall not be required to provide any of the Health Care Accountability Components provided in Section 3 to their Covered Employees until such time as the City's Health Director has prepared, and the Health Commission has approved, minimum standards for health plan benefits pursuant to Section 3.1(a). The Health Director and Health Commission shall proceed promptly to take these actions. From the date upon which the Health Commission approves such minimum standards forward, Contractors shall provide the Health Care Accountability Components set forth in Section 3 to their Covered Employees.

Section 11. Severability.

If any part or provision of this Policy, or the application of this Policy to any person, location or circumstance, is enjoined or held invalid by a court of law, the remainder of this Policy, including the application of such part or provisions to other persons, locations or circumstances, shall not be affected by such action and shall continue in full force and effect. To this end, the provisions of this Policy are severable. Further, to the extent Section 3.1(b)(a)(2) may be enjoined or held invalid by a court of law, the Contracting Party may alternatively comply in accordance with Section 3.3(b).

ATTACHMENT 17

EQUAL BENEFITS POLICY

Developer will comply with the Agency's Nondiscrimination in Contracts Policy, a copy of which is attached as Exhibit A.

EXHIBIT A

San Francisco Redevelopment Agency

Nondiscrimination in Contracts Policy

Section 1. Requirements in all Contracts.

(a) Nondiscrimination Provisions. The San Francisco Redevelopment Agency ("Agency") shall include in all Contracts and Property Contracts, hereinafter executed or amended, in any manner or as to any portion thereof, provisions obligating the Contractor or other party of said agreement not to discriminate on the basis of the fact or perception of a person's race, color, creed, religion, ancestry, national origin, age, sex, sexual orientation, Gender Identity, Domestic Partner status, marital status, disability or AIDS/HIV status, against any employee of, any Agency employee working with, any member of the public having contact with, or applicant for employment with, such Contractor, and shall require such Contractor to include a similar provision in all Subcontracts executed or amended thereunder. Contractor shall also comply with the Agency's Equal Opportunity Program.

(b) Nondiscrimination in Benefits. The Agency shall not execute or amend any Contracts or Property Contracts on or after the effective date of this Policy with any Contractor that discriminates in the provision of Benefits between employees with Domestic Partners and employees with spouses, and/or between the Domestic Partners and spouses of such employees, where the Domestic Partnership has been registered with a governmental entity pursuant to state or local law authorizing such registration, subject to the following conditions: In the event that the Contractor's actual cost of providing a certain benefit for the Domestic Partner of an employee exceeds that of providing it for the spouse of an employee, or the Contractor's actual cost of providing a certain benefit for the spouse of an employees exceeds that of providing it for the Domestic Partner of an employee, the Contractor shall not be deemed to discriminate in the provision of Benefits if the Contractor conditions providing such benefit upon the employee agreeing to pay the excess costs. In addition, in the event a Contractor is unable to provide a certain benefit, despite taking reasonable measures to do so, the Contractor shall not be deemed to discriminate in the provision of Benefits if the Contractor provides the employee with a Cash Equivalent. In adopting this Section 1(b), the intent of the Agency is to equalize to the maximum extent legally permitted the total compensation between similarly situated employees with spouses and employees with domestic partners.

Section 2. Definitions.

As used in this Policy the term:

(a) "Benefits" means any plan, program or Policy provided by an Agency Contractor to its employees as part of the employer's total compensation package. This includes, but is not limited to, the following types of Benefits: retirement plans; medical, dental and vision plans;

bereavement, family medical, parental and other leave policies; disability and life insurance plans; employee assistance programs; discounts; access to facilities, services and events; travel and relocation expenses; incentive, stock option, and profit sharing plans and other compensation programs.

(b) "Cash Equivalent" means the amount of money paid to an employee by an Agency Contractor who, despite taking all reasonable measures, is unable to end discrimination in Benefits. The Cash Equivalent shall be the amount of money paid by the Agency Contractor for the benefit given to a similarly situated employee.¹ To the extent that an Agency Contractor limits the availability of any benefit to the spouses of employees, or vice versa, the availability of a Cash Equivalent may be similarly limited.² The Cash Equivalent payment shall be made either on the same schedule as the Agency Contractor uses for the benefit given to employees with spouses, or, if no such schedule exists, on another schedule so long as such payment is made no less than once per month. No Cash Equivalent payment will be required where making such a payment would violate federal or state law.

(c) "Contract" shall mean an agreement for public works or improvements to be performed, or for goods or services to be purchased or grants to be provided at the expense of the Agency or to be paid out of moneys deposited in the treasury or out of trust moneys under the control or collected by the Agency, and does not include Property Contracts, agreements entered into pursuant to settlement of legal proceedings, contracts for urgent litigation expenses, or contracts for a cumulative amount of \$5,000 or less per vendor in each fiscal year.

(d) "Contractor" means any person or persons, firm, partnership, corporation, or combination thereof, who submits a bid and/or enters into a Contract or Property Contract with the Agency.

(e) "Domestic Partner" shall mean any person who has a currently registered Domestic Partnership with a governmental body pursuant to state or local law authorizing such registration. An Agency Contractor may also institute an internal Domestic Partnership registry to allow for the provision of equal Benefits to employees with Domestic Partnerships who do not register their partnerships pursuant to a governmental body authorizing such registration, or who are located in a jurisdiction where no such governmental Domestic Partnership registry exists.³

¹ The following scenario is provided as an example of similarly situated employees: An Agency Contractor with locations in Dallas, TX and Bridgeport, CT, offers spousal health insurance to its employees. After taking all reasonable measures, the Agency Contractor is still unable to provide health insurance for the Domestic Partners of its employees. The Cash Equivalent it would pay to its Bridgeport employees would be the amount of money paid by the Agency Contractor for Benefits given to employees with spouses in Bridgeport; the Cash Equivalent the Agency Contractor would pay to its Dallas employees would be the amount of money paid by the Agency Contractor or Benefits given to employees with spouses in Dallas.

² The following scenario is provided as an example of limiting the availability of a Cash Equivalent: An Agency Contractor limits the availability of spousal health insurance coverage to only those spouses who are not already covered by their own employer's health insurance plan. This Agency Contractor is unable to provide health insurance to the Domestic Partners of its employees and instead offers a Cash Equivalent. The Agency Contractor may limit the availability of a Cash Equivalent payment to only those employees whose Domestic Partners are not already covered by their own employer's health insurance plan.

(f) "Gender Identity" shall mean a person's various individual attributes as they are understood to be masculine and/or feminine.

(g) "Nondiscrimination in Benefits" means the equality of Benefits between employees with spouses and employees with Domestic Partners, between spouses of employees and Domestic Partners of employees, and between dependents and family members of spouses and dependents and family members of Domestic Partners.

(h) "Policy" shall mean this Nondiscrimination in Contracts Policy.

(i) "Property Contract" shall mean a written agreement for the exclusive use or occupancy of real property for a term exceeding 29 days in any calendar year, whether by singular or cumulative instrument, (i) for the operation or use by others of real property owned or controlled by the Agency for the operation of a business, social, or other establishment or organization, including leases, concessions, franchises and easements, or (ii) for the Agency's use or occupancy of real property owned by others, including leases, concessions, franchises and easements. For the purposes of this Policy, "exclusive use" means the right to use or occupy real property to the exclusion of others, other than the rights reserved by the fee owner. "Property Contract" shall not include a revocable at will use or encroachment permit for the use of or encroachment on Agency property regardless of the ultimate duration of such permit, except that "Property Contract" shall include such permits granted to a private entity for the use of Agency property for the purpose of a for-profit activity. "Property Contract" shall also not include contracts for the purchase or sale of land, Disposition and Development Agreements, Owner Participation Agreements, street excavation, street construction or street use permits, agreements for the use of Agency right of way where a contracting utility has the power of eminent domain, or agreements governing the use of Agency property which constitutes a public forum for activities that are primarily for the purpose of espousing or advocating causes or ideas and that are generally recognized as protected by the First Amendment to the U.S. Constitution, or which are primarily recreational in nature.

(j) "Sexual Orientation" shall mean the status of being lesbian, gay, bisexual or heterosexual.

(k) "Subcontract" shall mean an agreement to (i) provide goods and/or services, including construction labor, materials or equipment, to a Contractor, if such goods or services are procured or used in the fulfillment of the Contractor's obligations arising from a contract or agreement with the Agency, or (ii) to transfer the right to occupy or use all or a portion of a real property interest subject to a Property Contract to a Subcontractor and pursuant to which the Contractor remains obligated under the Property Contract.

(l) "Subcontractor" means any person or persons, firm, partnership, corporation or any combination thereof, who enters into a contract or agreement with a Contractor to perform 10 percent or more of the Contract or Property Contract.

³ Sample language for an internal Domestic Partnership registry is available through the Agency.

Section 3. Procedures for Implementation.

(a) Evidence of Compliance. Prior to executing a Contract or Property Contract, Contractors shall demonstrate that they are in compliance with the Nondiscrimination in Benefits requirements and, to the extent they are not in compliance with them, that the Contractor complies with one or more of the provisions in Section 3 (b) through (d) below, by providing either:

- (i) evidence that the Contractor has been certified by the Human Rights Commission of the City as being in compliance with Section 12 B 1 (b) of the San Francisco Administrative Code; or
- (ii) such forms and documentary evidence as may be requested by the Agency.

(b) Phase-In Periods. An Agency Contractor will not be deemed to be discriminating in the provision of Benefits where the implementation of policies ending discrimination in Benefits is delayed following the first award of an Agency contract to an Agency Contractor after July 1, 1998 if:

- (i) until the first effective date after the first open enrollment process following the date the contract with the Agency begins, provided that the Agency Contractor submits to the Agency evidence that reasonable efforts are being undertaken to end discrimination in Benefits. This delay may not exceed two years from the date the contract with the Agency is entered into, and only applies to Benefits for which an open enrollment process is applicable;⁴ or
- (ii) until administrative steps can be taken to incorporate Nondiscrimination in Benefits into the Agency Contractor's benefit package. The time allotted for these administrative steps shall apply only to those Benefits for which administrative steps are necessary and may not exceed three (3) months after the Contract award. An extension of this time may be granted at the discretion of the Executive Director of the Agency upon the written request of the Agency Contractor; or
- (iii) until the expiration of an Agency Contractor's current collective bargaining agreement(s) where all of the following conditions have been met:

⁴ For purposes of this provision, the term "effective date" refers to the date upon which the next Benefit plan year begins; the term "open enrollment period" refers to the time when employees are eligible to enroll themselves or others in the Agency Contractor's Benefit plan; the term "open enrollment process" begins when the Agency Contractor starts planning for, and negotiating with its insurance provider(s) regarding, the Benefits to be offered during the next Benefits plan year, and ends at the next effective date.

- I. the provision of Benefits is governed by one or more collective bargaining agreement(s);
- II. the Agency Contractor has taken all reasonable measures to end discrimination in Benefits by either requesting that the Union(s) involved agree to reopen the agreement(s) in order for the Agency Contractor to take whatever steps necessary to end discrimination in Benefits or by ending discrimination in Benefits without reopening the collective bargaining agreement(s);
- III. the Agency Contractor cannot end discrimination in Benefits despite taking all reasonable measures to do so; and
- IV. the Agency Contractor provides a Cash Equivalent to eligible employees for whom Benefits are not available.

(c) Reasonable Measures. An Agency Contractor will not be deemed to be discriminating in the provision of Benefits where, after taking all reasonable measures, the Agency Contractor is unable to end discrimination in Benefits and instead provides the closest approximation of equal Benefits available. If the cost of providing the closest approximation of equal Benefits is at least 33 percent less expensive than the cost of providing equal Benefits, the Agency Contractor must also make a Cash Equivalent payment.⁵ The Agency will determine whether an Agency Contractor has taken all reasonable measures upon the review of information and attached compelling documentation provided by the Agency Contractor that demonstrates that it is not possible for the Agency Contractor to end discrimination in Benefits. A determination that it is not possible for the Agency Contractor to end discrimination in Benefits shall be based upon a consideration of such factors as:

- (i) Benefits providers identified and contacted, in writing, by the Agency Contractor, and written documentation from these providers that they will not provide equal Benefits;
- (ii) the existence of Benefits providers willing to offer equal Benefits to the Agency Contractor; and
- (iii) the existence of federal or state laws which preclude the Agency Contractor from ending discrimination in Benefits.

(d) Alternate Methods of Structuring Benefits. So long as an Agency Contractor does not discriminate in the provision of Benefits between employees with spouses and employees with Domestic Partners, an Agency Contractor may elect to provide Benefits:

⁵ The following scenario is provided as an example of this provision: An Agency Contractor provides health insurance coverage for the spouses of its employees under Plan A. Plan A is unwilling to cover the Domestic Partners of employees. Plan B will provide coverage to Domestic Partners of employees, but is not as good as Plan A because there is a higher deductible and no prescription coverage. The Agency Contractor pays \$100 toward the premium for spousal coverage under Plan A. Because Plan B is less expensive, the Agency Contractor pays \$67 toward the premium for Domestic Partner coverage under Plan B, which is 33% less than the amount paid under Plan A. In order to not discriminate in the provision of Benefits, the Agency Contractor must provide a Cash Equivalent of \$33 to those employees who elect coverage for their Domestic Partners under Plan B.

- (i) to individuals in addition to employees' spouses and employees' Domestic Partners;
- (ii) on a basis unrelated to both marital status and Domestic Partner status; or
- (iii) neither to employees' spouses nor to employees' Domestic Partners.

Section 4. Waivers and Exceptions.

(a) Waivers - Executive Director. The Executive Director will waive the requirements of this Policy upon making written findings that the circumstances in (i) or (ii) below exist:

(i) Sole Source Contract occurs when:

- I. the goods or services to be purchased by the Agency are needed; and
- II. there is only a sole source available to provide the Agency with the needed goods or services; and
- III. the prospective Contractor is not currently disqualified from doing business with the Agency, or from doing business with any governmental agency based on any contract compliance requirements; and
- IV. the contracting department or commission has explained to the prospective Contractor the Nondiscrimination in Benefits requirements of the Policy and the prospective Contractor has refused to stop discriminating in the provision of Benefits; and
- V. the Agency (A) constructs the Contract for the shortest reasonable duration and (B) attempts to award any future Contracts for the needed goods or services to a Contractor that does not discriminate in the provision of Benefits by developing contacts with other providers who do comply with the Nondiscrimination in Benefits requirements of the Policy and/or by assisting the sole source provider with full compliance with the Nondiscrimination in Benefits requirements of the Policy.

(ii) Emergency Contract occurs when: the Contract is necessary to respond to an emergency which endangers the public health or safety and no entity which complies with the requirements of this Policy capable of performing the emergency work is immediately available.

(b) Waivers - Commission. The Agency Commission may waive by resolution any or all of the requirements of this Chapter in any instance in which:

- (i) the Executive Director finds that there are no qualified responsive bidders or prospective Contractors who comply with the requirements of this Policy and that the Contract is for an essential Agency service or project; or
- (ii) the Executive Director finds that transactions entered into pursuant to bulk purchasing arrangements through federal, state or regional entities which actually reduce the Agency's purchasing costs would be in the best interests of the Agency.

(c) Exceptions - Public Entities as Contractors. This Policy shall not apply where the prospective Contractor is a public entity and the Executive Director finds that goods, services, construction services for a public work or improvement or interest in or right to use real property of comparable quality or accessibility as are available under the proposed Contract or Property Contract are not available from another source, or that the proposed Contract or Property Contract is necessary to serve a substantial public interest.

(d) Exceptions - Grants or Agreements with Public Entities. This Policy shall not apply where the Executive Director finds that its requirements will violate or are inconsistent with the terms or conditions of a grant, subvention or agreement with a public agency or the instructions of an authorized representative of any such agency with respect to any such grant, subvention or agreement, provided that the Executive Director has made a good faith attempt to change the terms or conditions of any such grant, subvention or agreement to authorize application of this Policy.

(e) Exceptions - Financial or Investment Services and Litigation Expenses. This Policy shall not apply to:

- (i) the investment of trust moneys or agreements relating to the management of trust assets; or
- (ii) Agency moneys invested in U.S. government securities or under pre-existing investment agreements; or
- (iii) the investment of Agency moneys where the Executive Director finds that:
 - I. no person, entity or financial institution doing business in San Francisco which is in compliance with this Policy is capable of performing the desired transaction(s); or
 - II. the Agency will incur a financial loss which in the opinion of the Executive Director would violate the Agency's fiduciary duties. This subparagraph (e) shall be subject to the requirement that Agency moneys shall be withdrawn or divested at the earliest possible maturity date if deposited or invested with a person, entity or financial institution other than the U.S. government which does not comply with this Policy; or
- (iv) Contracts for urgent litigation expenses, where the Agency General Counsel certifies in writing to the Executive Director that the Contract involves specialized litigation

requirements such that it would be in the best interests of the Agency to waive the requirements of this Policy.

Section 5. Jurisdiction.

(a) Subcontractors. The Nondiscrimination provisions in Section 1 (a) do apply to Subcontractors. However the Nondiscrimination in Benefits requirements in Section 1 (b) do not apply to Subcontractors.

(b) Location. The Nondiscrimination in Benefits requirements apply to all locations throughout the United States where a Contractor is doing business.

(c) Covered Entity. The entity which enters into a contract with the Agency is the entity which must comply with the Policy.

(d) Subsidiaries and Joint Ventures. Separate corporate entities, including parents and subsidiaries of the entity which contracts with the Agency, are not required to comply with the ordinance. In the case of a joint venture, all joint venture partners will be required to comply. The Agency will examine the corporate structure of the entity to determine whether it has been created for separate, independent and legitimate business reasons, and not for the purpose of avoiding the ordinance. The factor to be included in this determination shall include:

- (i) the legal status of the entity;
- (ii) the way in which and location where Benefits are administered;
- (iii) the authority of the person signing the contract; and
- (iv) any other factors deemed relevant by the Executive Director.

Section 6. Effective Date.

The Nondiscrimination in Benefits provisions shall not apply to any Contracts or Property Contracts executed or amended prior to July 1, 1998, or to bid packages advertised and made available to the public, or any competitive or sealed bids received by the Agency, prior to July 1, 1998.

Section 7. Miscellaneous.

(a) Verification of Domestic Partnership or Marriage. An Agency Contractor may verify the existence of a Domestic Partnership or marriage to the extent such verification is undertaken equally for employees with Domestic Partners and employees with spouses.

(b) Excess Costs. In the event that the actual cost of providing a certain benefit to an employee with a Domestic Partner or an employee's Domestic Partner exceeds that of providing the benefit to an employee with a spouse or to an employee's spouse, or vice versa, the Agency Contractor

may condition Nondiscrimination in Benefits upon the employees agreeing to pay the excess costs. The excess costs the Agency Contractor may pass on to the employee may include only the actual costs of the benefit for that employee and may not include implementation or administrative costs, any tax consequence to the employer, or additional costs to other employees.

(c) Taxation. For the purposes of this Policy:

- (i) the withholding of income tax from an employee for income associated with the provision of Benefits is permissible to the extent the taxation is required by state or federal law; and
- (ii) nothing in these rules is intended to require an Agency Contractor to take any action that would jeopardize the tax-qualified status of a retirement plan.

(d) Notification. Notification by an Agency Contractor to its employees regarding the provision of Benefits to employees with spouses and employees with Domestic Partners must be conducted so that all employees are given equal notice of all available Benefits.

(e) Continuation Coverage. The continuation of Benefits, including health Benefits, should be provided equally to the spouses of employees and the Domestic Partners of employees, except where otherwise prohibited by law.

Section 8. Authority.

The Executive Director, or his or her designee, is hereby granted the power to do all acts and exercise all powers referred to in this Policy, provided however, that all Contracts or Property Contracts for an amount exceeding \$20,000 must be approved by the Agency Commission in accordance with the Agency's Purchasing Policy.

Section 9. Severability.

This Policy shall be construed so as not to conflict with applicable federal or state laws, rules or regulations. Nothing in this Policy shall authorize the Agency to impose any duties or obligations in conflict with limitations on local authority established by federal law at the time such Agency action is taken. In the event that a court or agency of competent jurisdiction holds that state or federal law, rule or regulation invalidates any clause, sentence, paragraph or section of this Chapter or the application thereof to any person or circumstances, it is the intent of the Agency that the court or agency serve such clause, sentence, paragraph or section so that the remainder of this Policy shall remain in effect.

s:\forms\dompar6.doc 3/2/98



SAN FRANCISCO REDEVELOPMENT AGENCY
INSTRUCTIONS FOR DECLARATION FORM
Nondiscrimination in Contracts and Benefits

A. What is the Nondiscrimination in Contracts Policy?

The San Francisco Redevelopment Agency's Nondiscrimination in Contracts Policy (Policy) requires companies or organizations providing products or services to, or leasing a real property from, the Agency to agree not to discriminate against groups who are protected from discrimination under the Policy, and to include a similar provision in subcontracts and other agreements. Those provisions are the subjects of this form. The Policy is posted on the Web at: www.ci.sf.ca.us/sfra.

If you do not comply with the Policy, the Agency cannot do business with you, except under certain very limited circumstances.

B. What Agency contracts are covered by the Policy?

- Contracts or purchase orders where the Agency purchases products, services or construction with contractors/vendors whose total amount of business with the Agency exceeds a cumulative amount of \$5,000 in a 12-month period.
- Leases of property owned by the Agency for a term of 30 days or more. In these cases, the Agency is the landlord. The Policy also applies to leases for a term of 30 days or more where the Agency is the tenant.

C. What are the groups protected from discrimination under the Policy?

You may not discriminate against:

- your employees
- an applicant for employment
- any employee of the Agency or the City and County of San Francisco
- a member of the public having contact with you.

D. What are prohibited types of discrimination?

You may not discriminate against the specified groups for the following reasons (see Question 1a on the declaration form).

- | | |
|----------------------|---------------------------|
| • race | • color |
| • creed | • religion |
| • ancestry | • national origin |
| • age | • sex |
| • sexual orientation | • gender identity |
| • marital status | • domestic partner status |
| • disability | • AIDS/HIV status |

In the provision of benefits, you also may not discriminate between employees with spouses and employees with domestic partners, or between the spouses and domestic partners of employees, subject to the conditions listed in F.2 below.

E. How are subcontracts affected?

For any subcontract, sublease, or other subordinate agreement you enter into which is related to a contract you have with the Agency, you must include a nondiscrimination provision (See Question 1b on the Declaration Form). The subcontracting provision need not

include nondiscrimination in benefits as part of the nondiscrimination requirements. If you're unsure whether a contract qualifies as a subcontract, contact the Agency division administering your contract with the Agency. "Subcontract" also includes any subcontract of your subcontractor for performance of 10% or more of the subcontract.

INSTRUCTIONS FOR DECLARATION FORM
Nondiscrimination in Contracts and Benefits

F. Nondiscrimination in benefits for spouses and domestic partners

1. Who are domestic partners?

If your employee and another person are currently registered as domestic partners with a state, county or city that authorizes such registration, then those two people are domestic partners. It doesn't matter where the domestic partners now live or whether they are a same-sex couple or an opposite sex couple. A company/organization may also institute its own domestic partnership registry (contact the Agency for more information).

2. What is nondiscrimination in benefits?

You must provide the same benefits to employees with spouses and employees with domestic partners, and to spouses and domestic partners of employees, subject to the following qualifications (See Question 2c on the Declaration Form).

- If your cost of providing a benefit for an employee with a domestic partner exceeds that of providing it for an employee with a spouse, or vice versa, you may require the employee to pay the excess cost.
- If you are unable to provide the same benefits, despite taking all reasonable measures to do so, you must provide the employee with a cash equivalent. This qualification is intended to address situations where your benefits provider will not provide equal benefits and you are unable to find an alternative source or state or federal law prohibit the provision of equal benefits. (See Question 2d on the Declaration form).
- The Policy does not require any benefits be offered to spouses or domestic partners. It does require, however, that whatever benefits are offered to spouses be offered equally to domestic partners, and vice versa.

3. Examples of benefits

The law is intended to apply to all benefits offered to employees with spouses and employees with domestic partners. A sample list appears in Question 2c on the Declaration Form.

G. Form required

Complete the Declaration Form to tell the Agency whether you comply with the Policy. All parties to a Joint Venture must submit separate Declarations.

Please submit an original of the Declaration Form and keep a copy for your records. If an Agency division should ask you to complete the form again, you may submit a copy of the form you originally submitted (if the information has not changed), unless you are advised otherwise.

H. Attachments

If you provide equal benefits, as indicated by your answers to Question 2c on the Declaration form, **YOU MUST ATTACH DOCUMENTATION TO THIS FORM**, unless such documentation does not exist. See item 3, "Documentation for Nondiscrimination in Benefits." If documentation does not exist, attach an explanation (e.g., some of your policies are unwritten).

I. If your answers change

If, after you submit the Declaration, your company/organization's nondiscrimination policy or benefits change such that the information you provided to the Agency is no longer accurate, you must advise the Agency promptly by submitting a new Declaration.



SAN FRANCISCO REDEVELOPMENT AGENCY

DECLARATION FORM

Nondiscrimination in Contracts and Benefits

1. Nondiscrimination—Protected Classes

a. Is it your company/organization’s policy that you will not discriminate against your employees, applicants for employment, employees of the San Francisco Redevelopment Agency (Agency) or City and County of San Francisco (City), or members of the public for the following reasons:

- race Yes No
- color Yes No
- creed Yes No
- religion Yes No
- ancestry Yes No
- national origin Yes No
- age Yes No
- sex Yes No
- sexual orientation Yes No
- gender identity Yes No
- marital status Yes No
- domestic partner status Yes No
- disability Yes No
- AIDS or HIV status Yes No

b. Do you agree to insert a similar nondiscrimination provision in any subcontract you enter into for the performance of a substantial portion of the contract that you have with the Agency or the City?

- Yes No

If you answered “no” to any part of Question 1a or 1b, the Agency or the City cannot do business with you.

2. Nondiscrimination—Equal Benefits (Question 2 does not apply to subcontracts or subcontractors)

a. Do you provide, or offer access to, any benefits to employees with spouses or to spouses of employees?

- Yes No

b. Do you provide, or offer access to, any benefits to employees with domestic partners (Partners) or to domestic partners of employees?

- Yes No

If you answered “no” to both Questions 2a and 2b, skip 2c and 2d, and sign, date and return this form. If you answered “yes” to Question 2a or 2b, continue to 2c.

c. If “yes,” please indicate which ones. This list is not intended to be exhaustive. Please list any other benefits you provide (even if the employer does not pay for them).

Benefit	Yes, for Spouses	Yes, for Partners	No

- Medical (health, dental, vision)
- Pension
- Bereavement
- Family leave
- Parental leave
- Employee assistance programs
- Relocation and travel
- Company discounts, facilities, events
- Credit union
- Child care
- Other _____
- Other _____

DECLARATION FORM
Nondiscrimination in Contracts and Benefits

d. If you answered "yes" to Question 2a or 2b, and in 2c indicated that you do not provide equal benefits, you may still comply with the Policy if you have taken all reasonable measures to end discrimination in benefits, have been unable to do so, and now provide employees with a cash equivalent.

- (1) Have you taken all reasonable measures? Yes No
(2) Do you provide a cash equivalent? Yes No

3. Documentation for Nondiscrimination in Benefits (Questions 2c and 2d only)

If you answered "yes" to any part of Question 2c or Question 2d, you must attach to this form those provisions of insurance policies, personnel policies, or other documents you have which verify your compliance with Question 2c or Question 2d. Please include the policy sections that list the benefits for which you indicated "yes" in Question 2c. If documentation does not exist, attach an explanation, e.g., some of your personnel policies are unwritten. If you answered "yes" to Question 2d(1) complete and attach form SFRA/CC-103, "Nondiscrimination in Benefits—Reasonable Measures Affidavit," which is available from the Agency. You need not document your "yes" answer to Question 1a or Question 1b.

I declare (or certify) under penalty of perjury that the foregoing is true and correct, and that I am authorized to bind this entity contractually.

Executed this _____ day of _____, 200____, at _____, _____
(City) (State)

Name of Company/Organization: _____

Doing Business As (DBA): _____

Also Known As (AKA): _____

General Address: _____
(For General Correspondence) _____

Remittance Address: _____
(If different from above address) _____

Name of Signatory: _____ Title: _____
(Please Print)

Signature: _____

Phone Number: _____ Federal Tax Identification Number: _____

Approximate number of employees in the U.S.: _____ Vendor Number: _____
(if known)

- Check here if your address has changed.
- Check here if your organization is a non-profit.
- Check here if your organization is a governmental entity.

ATTACHMENT 18

FORM OF [ARCHITECT'S] [ENGINEER'S] CERTIFICATE RE COMPLIANCE OF DESIGN WITH LAWS RE ACCESS

TO: San Francisco Redevelopment Agency
770 Golden Gate Avenue
San Francisco, California 94102

Development: Hunters Point Shipyard

Property: _____

DATE: _____

FROM: [Architect] [Engineer] of Record

This Certificate is being provided pursuant to Section 4.3 of that certain Disposition and Development Agreement for Hunters Point, Phase 1, by and between the Redevelopment Agency of the City and County of San Francisco, a public body, corporate and politic, of the State of California (the "Agency") and Lennar/BVHP LLC, a California limited liability company doing business as Lennar/BVHP Partners ("Developer"), dated _____, 200__, and recorded in the City's Official Records on _____, 200__, as Document No. _____ (the "Agreement"). Terms not defined in this Certificate have the meanings given to them in the Agreement.

As [Architect] [Engineer] of Record for the construction of the Horizontal Improvements, I examined schematic drawings dated _____, 20__ [identify by document set or other information] (the "Schematic Drawings") for conformity to local, state, and federal building laws and regulations with respect to Accessibility for Persons with Disabilities.

I hereby declare it is my professional opinion that design of the Horizontal Improvements has been performed in accordance with all applicable local, state, and federal building laws and regulations with respect to Accessibility for Persons with Disabilities.

[Architect/Engineer of Record]

By: _____

Its: _____

ATTACHMENT 19

FORM OF [ARCHITECT'S] [ENGINEER'S] INSPECTION CERTIFICATE

TO: San Francisco Redevelopment Agency
770 Golden Gate Avenue
San Francisco, California 94102

Development: Hunters Point Shipyard

Property: _____

DATE: _____

FROM: [Architect] [Engineer] of Record

This Certificate is being provided pursuant to Section 4.4 of that certain Disposition and Development Agreement for Hunters Point, Phase 1, by and between the Redevelopment Agency of the City and County of San Francisco, a public body, corporate and politic, of the State of California (the "Agency") and Lennar/BVHP LLC, a California limited liability company doing business as Lennar/BVHP Partners ("Developer"), dated _____, 200__, and recorded in the City's Official Records on _____, 200__, as Document No. _____ (the "Agreement"). Terms not defined in this Certificate have the meanings given to them in the Agreement.

As [Architect] [Engineer] of Record for the design and construction of the Horizontal Improvements, I observed the Horizontal Improvements on _____, 20__, and all the statements made below are made as of the date(s) of my observation(s). I hereby declare it is my professional opinion that:

1. Based on my observation, the construction of the Horizontal Improvements has been and is being performed in accordance with those elements of the Construction Documents for the Horizontal Improvements approved by the Agency pursuant to Section 4 of the Agreement, except as may be noted on Exhibit A attached hereto.

2. Based on my observation, the construction of the Horizontal Improvements has been done in a good and workerlike manner, and all of the work, materials and fixtures are acceptable, except as may be noted on Exhibit A attached hereto.

3. The construction heretofore completed on the Horizontal Improvements complies with all applicable local, state and federal building laws, regulations and ordinances, except as may be noted on Exhibit A attached hereto.

4. The required certificates, approvals and permits of all governmental authorities having jurisdiction covering the work to date on the Horizontal Improvements have been issued and are in force, and there is not an undischarged violation of applicable laws, regulations or orders of any governmental authority having jurisdiction of which I have notice as of the date hereof, except as may be noted on Exhibit A attached hereto.

5. Construction of the Horizontal Improvements is progressing satisfactorily so that it can be completed in accordance with those elements of the Construction Documents for the Horizontal Improvements approved by the Agency pursuant to Section 4 of the Agreement by the completion date set forth in the Schedule of Performance for Horizontal Improvements, as such date may have been extended in accordance with the provisions of the Agreement.

[Architect/Engineer of Record]

By: _____
Its: _____

EXHIBIT A

EXCEPTIONS TO [ARCHITECT'S] [ENGINEER'S] INSPECTION CERTIFICATE

DATE: _____

The statements made on the [Architect's] [Engineer's] Inspection Certificate to which this Exhibit is attached are subject to the following exceptions:

ATTACHMENT 20

FORM OF [ARCHITECT'S] [ENGINEER'S] CERTIFICATE RE COMPLIANCE OF CONSTRUCTION WITH LAWS RE ACCESS

TO: San Francisco Redevelopment Agency
770 Golden Gate Avenue
San Francisco, California 94102

Development: Hunters Point Shipyard

Property: _____

DATE: _____

FROM: [Architect] [Engineer] of Record

This Certificate is being provided pursuant to Section 4.4 of that certain Disposition and Development Agreement for Hunters Point, Phase 1, by and between the Redevelopment Agency of the City and County of San Francisco, a public body, corporate and politic, of the State of California (the "Agency") and Lennar/BVHP LLC, a California limited liability company doing business as Lennar/BVHP Partners ("Developer"), dated _____, 200__, and recorded in the City's Official Records on _____, 200__, as Document No. _____ (the "Agreement"). Terms not defined in this Certificate have the meanings given to them in the Agreement.

As [Architect] [Engineer] of Record for the construction of the Horizontal Improvements, I observed the Horizontal Improvements regarding Accessibility for Persons with Disabilities on _____ (date), and all the statements made below are made as of the date of my observation. I hereby declare it is my professional opinion that:

1. Based on my observation, the construction of the Horizontal Improvements with respect to Accessibility for Persons with Disabilities has been and is being performed in accordance and complies with all applicable local, state, and federal building laws and regulations with respect to Accessibility for Persons with Disabilities.

2. Based on my observation, the construction of the Horizontal Improvements with respect to Accessibility for Persons with Disabilities has been done in a good and workerlike manner, and all of the work, materials and fixtures are acceptable, except as may be noted on Exhibit A attached hereto.

3. In my opinion, construction of the Horizontal Improvements has been completed satisfactorily in accordance with all applicable local, state, and federal building laws and regulations with respect to Accessibility for Persons with Disabilities.

[Architect/Engineer of Record]

By: _____
Its: _____

EXHIBIT A

**EXCEPTIONS TO [ARCHITECT'S] [ENGINEER'S] CERTIFICATE RE
COMPLIANCE OF CONSTRUCTION WITH LAWS RE ACCESS**

DATE: _____

The statements made on the [Architect's] [Engineer's] Certificate Re Compliance of Construction with Laws Re Access to which this Exhibit is attached are subject to the following exceptions:

ATTACHMENT 21

FORM OF CERTIFICATE OF COMPLETION

Free Recording Requested Pursuant to
Government Code Section 27383

Recorded at the Request of the
San Francisco Redevelopment Agency

When Recorded, Please Mail to:

Lennar/BVHP, LLC

----- Space Above This Line for Recorder's Use -----

CERTIFICATE OF COMPLETION

WHEREAS, the Redevelopment Agency of the City and County of San Francisco, a public body, corporate and politic, of the State of California (the "Agency") and Lennar/BVHP, LLC, a California limited liability company doing business as Lennar/BVHP Partners ("Developer") have entered into the Disposition and Development Agreement for Hunters Point, Phase 1, dated _____, 200__, and recorded in the City's Official Records on _____, 200__, as Document No. _____ (the "Agreement"). The Agreement is on file with the Agency as a public record and is incorporated herein by reference. This Declaration is executed and recorded in accordance with the Agreement and partially satisfies the requirements therein. Terms not defined in this Certificate have the meanings given to them in the Agreement;

WHEREAS, by Grant Deed dated _____, 200__, and recorded in the City's Official Records on _____, 20__, as Document No. _____ (the "Deed"), the Agency did convey to Developer certain real property situated in the City and County of San Francisco, State of California ("City"), more particularly described in Exhibit A attached hereto and made a part hereof (the "Property");

WHEREAS, with respect to the Property, the Agency has determined that the Developer's construction obligations for Horizontal Improvements, as specified in the Deed and in the Agreement, have been fully performed and the Horizontal Improvements completed in accordance therewith;

WHEREAS, as stated in the Agreement, the Agency's determination regarding said construction obligations is not directed to, and thus the Agency assumes no responsibility for, latent defects; and

WHEREAS, Section ___ of the Deed contains conditions subsequent providing for forfeiture and reversion of title in event of violation of its provisions;

NOW, THEREFORE, as provided in the Agreement and the Deed, with respect to the above described Property, and subject to the foregoing provisions hereof, the Agency does hereby certify that said obligations and improvements for Horizontal Improvements have been performed fully and completed as aforesaid and that the conditions subsequent have been fully satisfied and are of no further force or effect by reason thereof.

Nothing contained in this instrument shall modify in any other way any other provision of the Agreement, the Deed, or any other provisions of those documents incorporated in the Deed.

IN WITNESS WHEREOF, the Agency has executed this instrument this _____ day of _____, 20__.

Authorized by Agency Resolution
No. _____ adopted March 27, 1962.

FORM APPROVED:

By: _____
Agency General Counsel

APPROVED:

By: _____
Development Services Manager

By: _____
Technical Services Manager

REDEVELOPMENT AGENCY OF THE
CITY AND COUNTY OF SAN
FRANCISCO, a public body, corporate and
politic

By: _____
Senior Deputy Executive Director

By: _____
Assistant Secretary

EXHIBIT A
LEGAL DESCRIPTION OF THE PROPERTY

ATTACHMENT 22

AFFORDABLE HOUSING PROGRAM

This Affordable Housing Program (the "Program") is attached to and made a part of the Disposition and Development Agreement for Hunters Point, Phase 1 (the "Agreement"). The Agreement applies in the first instance to Horizontal Improvements (such as streets, utilities, parks and the like), but it also includes terms and conditions that will apply to Vertical Improvements (such as residential units, commercial facilities, office space and the like). For clarity, Attachment 27 to the Agreement comprises a summary of the terms and conditions that will apply to Vertical Improvements, and it incorporates by reference certain Attachments to the Agreement. This is one such Attachment, since it outlines the Affordable Housing Program for Phase 1 and sets forth the rights and obligations of Agency and Vertical Developers in connection with the Program. Agency and Vertical Developers are bound by this Program as part of the obligations they assume, and benefits they receive, under the document that will incorporate the summary of terms and conditions set forth in Attachment 27.

Section 1 Overview.

1.1 Affordable Units. Phase 1 will include approximately 1,600 Residential Units. At least thirty-two percent (32%), and as much as forty-four percent (44%), of the Residential Units will comprise Affordable Housing for low- and moderate-income residents.

1.2 Baseline Affordable Housing. The baseline Phase 1 Affordable Housing Units will consist of (a) approximately three hundred twenty (320) Agency Affordable Housing Units to be built on Agency Housing Parcels and (b) Inclusionary Units comprising fifteen percent (15%, or approximately one hundred ninety-two (192) units) of the total Vertical Developer Residential Units to be built by third-party Vertical Developers, including Developer Affiliates, on the Project Site.

1.3 Option Units. Agency will also have the right to purchase up to an additional fifteen percent (15%, or approximately one hundred ninety-two (192) units) of the total Vertical Developer Residential Units to be built on the Project Site, on the terms and conditions set forth in this Program.

1.4 Income Targets. The median income in the Bayview Hunters Point community is approximately eighty percent (80%) of AMI. For-Sale Affordable Housing Units will be priced for households earning an average of eighty percent (80%) of AMI. For-Rent Affordable Housing Units will be priced for households earning no more than fifty percent (50%) of AMI. These income targets are approximately ten percent to twenty percent (10-20%) lower than those typically required for affordable housing units built in the City. Current HUD income levels are available from the Agency.

1.5 Affordable Residential Unit Distribution. Affordable Housing Units will be evenly distributed throughout Phase 1. The overall Phase 1 housing program for all Vertical Developer Residential Units will feature a mix of For-Rent and For-Sale Residential Units with thirty percent (30%) For-Rent and seventy percent (70%) For-Sale. The Agency will consider minor variations to this rate so long as the overall weighted average affordability level of the

Inclusionary Units does not exceed sixty-eight percent (68%) of AMI (as defined in Section 2 below). The distribution of Affordable Units within the Project Site (including the allocation of Affordable Units between For-Rent and For-Sale) consists of a fifteen percent (15%) Inclusionary Unit Requirement for each Residential Project, unless Agency and Developer or Vertical Developer agree otherwise, as shown on the map attached as Exhibit A. A Declaration of Rental Use Restriction, restricting Residential Units to For-Rent rather than For-Sale, substantially in the form attached as Exhibit B, will be recorded against each For-Rent Residential Unit in Phase 1, whether the Residential Unit is Affordable or Market Rate. A Declaration of Restrictions for For-Rent Affordable Housing Units, restricting For-Rent Affordable Residential Units to the specified affordability level, substantially in the form attached as Exhibit C, will be recorded against each For-Rent Affordable Residential Unit in Phase 1. Each For-Sale Affordable Residential Housing Unit must be sold to qualified members of the public as evidenced by an Affordable Housing Parcel Deed substantially in the form specified in Exhibit D. A Declaration of Restrictions for For-Sale Affordable Housing Units and Option to Purchase Agreement, restricting For-Sale Affordable Residential Units to the specified affordability level, substantially in the form attached as Exhibit D, will be recorded against each For-Sale Affordable Residential Unit.

1.6 Buyer Assistance. Vertical Developers will coordinate with appropriate agencies and financial institutions to provide qualified home buyers with access to down payment assistance, first-time buyer financing programs (from such entities as Fannie Mae, Federal Home Loan Bank, and similar entities) and homeownership counseling services as needed.

Section 2 Definitions.

Terms not defined in this Program have the meanings given to them in the Agreement.

Addendum to Deed of Trust has the meaning set forth in Section 3.3 and is substantially in the form of Attachment C to Exhibit D.

Affiliate has the meaning set forth in the Agreement as follows: A Person in which Developer or a Vertical Developer, as the case may be, directly or indirectly owns and/or controls (a) twenty five percent (25%) or more (or if such Person is not publicly traded, fifty percent (50%) or more) of each class of equity interests (including rights to acquire such interests), or (b) twenty five percent (25%) or more (or if such Person is not publicly traded, fifty percent (50%) or more) of each class of interests that have a right to nominate, vote for or otherwise select the members of the board or other governing body that directs or causes the direction of substantially all of the management and policies of that Person.

Affordable means, (a) with respect to a For-Rent Residential Unit, a monthly rental charge, including a utility allowance in an amount determined by the San Francisco Housing Authority, which does not exceed thirty percent (30%) of fifty percent (50%) of Area Median Income, based upon Imputed Household Size; and (b) with respect to a For-Sale Residential Unit, a purchase price based on a five percent (5%) down payment and a rate for a thirty (30) year fixed mortgage based on a ten (10) year rolling average of rates published in the Wall Street Journal, with a total of annual payments for principal, interest, taxes, assessments and

homeowner's association dues which does not exceed thirty-three percent (33%) of the Program Income Level.

Affordable Housing Parcel Deed means the deed conveying an Affordable Housing Parcel to the Agency.

Affordable Housing Units means, collectively, the Vertical Developer Inclusionary Units and Agency Affordable Housing Units.

Agency Affordable Housing Units means the Residential Units constructed on Agency Housing Parcels.

Agency Housing Parcels has the meaning set forth in the Agreement, as follows: The parcels to be retained by Agency and designated as Agency Housing Parcels on the map attached as Attachment 2 to the Agreement.

Area Median Income (AMI) has the meaning set forth in the Agreement, as follows: The area median income for a household, adjusted **solely** for actual household size, and not adjusted for other factors, including but not limited to, HUD high cost adjustments, as determined by HUD for the San Francisco Primary Metropolitan Statistical Area, from time to time.

Business Day has the meaning set forth in the Agreement, as follows: A day other than a Saturday, Sunday or a state or federal holiday.

City means the City and County of San Francisco, California, a municipal corporation.

Close or Closing for Option Units means the recordation of the deed evidencing the conveyance of Option Units to the Agency.

Complete Construction means the point at which Residential Units have been completed in accordance with approved plans and specifications, as reasonably determined by Agency, and a Certificate of Occupancy has been issued for such Residential Units.

Declaration of Rental Use Restriction has the meaning set forth in Section 3.1 and is substantially in the form attached as Exhibit B.

Declaration of Restrictions for For-Rent Affordable Housing Units has the meaning set forth in Section 3.3 and is substantially in the form attached as Exhibit C.

Declaration of Restrictions for For-Sale Affordable Housing Units and Option to Purchase Agreement has the meaning set forth in Section 3.3 and is substantially in the form attached as Exhibit D.

Design Review and Document Approval Procedure for Vertical Improvements means the document to be negotiated by Developer and the Agency and, if agreed upon, attached to the Agreement, as it may be amended from time to time.

Developer means LENNAR/BVHP, LLC, a California limited liability company doing business as Lennar/BVHP Partners.

Direct Costs means all costs incurred by Vertical Developer in constructing the Units, excluding Land Cost, Indirect Costs, and Vertical Developer Profit, for each Major Residential Phase. Direct Costs shall include costs and expenses actually incurred and paid for construction of the Units, including fees for inspections and building permits and other permit fees, the fees of engineers, surveyors and architects providing services in connection with the construction of Units for each Major Phase, and the costs of options and upgrades to the Units, but shall specifically exclude amounts paid to any Affiliate of the Vertical Developer unless Agency gives its prior written approval. Agency will not unreasonably withhold its approval so long as Vertical Developer provides supporting information substantiating that any such payments do not exceed amounts that would be payable to non-related parties in an arms length transaction for similar services within the City. The amount of any Direct Costs is subject to verification and reasonable approval by Agency. Any costs that cannot be reasonably verified through statements and invoices shall not be included as "Direct Costs." Vertical Developer shall timely provide to Agency a schedule specifically identifying and substantiating all Direct Costs claimed, showing in particular the basis on which Direct Costs were allocated to the Units in a particular Major Phase, together with supporting materials, in a form reasonably satisfactory to Agency.

Escrow has the meaning set forth in Section 3.5(h).

For-Rent or Rental means a Residential Unit that is intended at the time of Complete Construction to be occupied subject to a lease, and not offered for sale.

For-Sale or Sale means a Residential Unit that is intended at the time of Complete Construction to be offered for sale, e.g., as a condominium for individual Residential Unit ownership.

Grant Deed has the meaning set forth in Section 3.3.

HUD means the United States Department of Housing and Urban Development.

Imputed Household Size means the total number of bedrooms in a Residential Unit plus one (1).

Inclusionary Unit means an Affordable Residential Unit to be constructed by a Vertical Developer pursuant to this Program and the Agreement, which shall be either For-Rent or For-Sale housing offered in accordance with the terms of this Program.

Indirect Costs means all costs and charges incurred by the Vertical Developer in constructing Units for each Major Phase, excluding Land Cost, Direct Costs and Vertical Developer Profit. By way of example, Indirect Costs shall include without limitation costs and charges such as site indirect costs, overhead or charges for on-site personnel, depreciation of capital expenditures or equipment, real property taxes and assessments, insurance expenses, financing expenses or interest, the cost of performing warranty work and maintaining warranty reserves, legal fees and expenses, general business taxes or licenses, closing costs incurred in connection with sales of Units and other costs customarily treated as "soft costs" in the home

building industry; provided that, Indirect Costs shall specifically exclude (a) sales or marketing expenses, since this term is used to calculate the Option Purchase Price and no marketing or sale expenses are required for Option Units and (b) amounts paid to any Affiliate of the Vertical Developer unless the Agency gives its prior written approval. Agency will not unreasonably withhold its approval so long as Vertical Developer provides supporting information substantiating that any such payments do not exceed amounts that would be payable to non-related parties in an arms length transaction for similar services within the City. The amount of any Indirect Costs is subject to verification and reasonable approval by Agency. Any costs that cannot be reasonably verified through statements and invoices shall not be included as "Indirect Costs." The Vertical Developer shall timely provide to Agency a schedule substantiating all Indirect Costs claimed, showing in particular the basis on which Indirect Costs were allocated to the Units in a particular Major Phase, together with supporting materials, in a form reasonably satisfactory to Agency. The parties agree that irrespective of the Indirect Costs actually incurred, the amount designated as Indirect Costs for purposes of determining the Option Purchase Price shall not exceed twenty percent (20%) of Direct Costs, provided that builder's risk and property insurance costs will be included in the Option Purchase Price even if they cause Indirect Costs to exceed twenty percent (20%) of Direct Costs.

Infrastructure has the meaning set forth in the Agreement.

Infrastructure Plan means the document attached to the Agreement as Attachment 9, as it may be amended from time to time.

Land Cost means the verified cash purchase price allocated among the Residential Units to be developed in the relevant Major Phase. The Land Cost is subject to verification and reasonable approval by Agency. Any costs that cannot be reasonably verified through closing statements and other documentation shall not be included as "Land Cost." The Vertical Developer shall timely provide to Agency a schedule substantiating all Land Costs claimed, showing in particular the basis on which Land Costs were allocated to the Units in a particular Major Phase, together with supporting materials, in a form reasonably satisfactory to Agency.

Major Phase means a development segment comprising one or more of the numbered parcels or portions of parcels included with a numbered parcel (or a remainder parcel if so approved by Agency pursuant to the Design Review and Document Approval Procedure for Vertical Improvements), as shown on Attachment 2 to the Agreement containing one or more Residential Projects.

Major Phase Housing Data Table has the meaning set forth in Section 3.6 and is substantially in the form attached as Exhibit G.

Market Rate or **Market Rate Residential Unit** means a Residential Unit that has no restrictions under this Affordable Housing Program or the Agreement with respect to affordability levels or income restrictions for occupants.

Memorandum of Option has the meaning set forth in Section 3.5(a) and is substantially in the form attached as Exhibit E.

Option Purchase Price has the meaning set forth in Section 3.5(e).

Option Units has the meaning set forth in Section 3.5(a).

Owner means the person or entity holding fee title to a parcel or Residential Unit in Phase 1.

Option Unit Exceptions has the meaning set forth in Section 3.5(c).

Project Housing Data Table has the meaning set forth in Section 3.7 and is substantially in the form attached as Exhibit H.

Program Income Level means the maximum AMI allowed for Affordable Units within a development based on Imputed Household Size.

Project Site has the meaning set forth in the Agreement.

Promissory Note Secured By Deed of Trust has the meaning set forth in Section 3.3 and is substantially in the form of Attachment A to Exhibit D.

Qualified Land Buyer has the meaning set forth in the Agreement.

Redevelopment Requirements has the meaning set forth in the Agreement.

Release of Option Rights means the document, substantially in the form attached as Exhibit E, in which the Agency releases its right to purchase Vertical Developer Residential Units in a specific Residential Project, other than those specific Option Units that Agency has elected to purchase under this Attachment 22.

Residential Project means a development containing Residential Units and possibly containing other uses permitted under the Redevelopment Plan for the Hunters Point Naval Shipyard and this Affordable Housing Program, which is undertaken by the Developer through the Agreement or Vertical Developers through a Disposition and Development Agreement or other land transfer agreements, including but not limited to, ground leases.

Residential Unit means a dwelling unit consisting of a room or suite of two (2) or more rooms that is designed for residential occupancy.

Short Form Deed of Trust and Assignment of Rents has the meaning set forth in Section 3.3 and is substantially in the form of Attachment B to Exhibit D.

Title Company has the meaning set forth in Section 3.5(h).

Title Report has the meaning set forth in Section 3.5(b).

Total Residential Units has the meaning set forth in Section 3.

Total Vertical Developer Residential Units means the total of Vertical Developer Market Rate Residential Units and Inclusionary Units developed in Phase 1.

Vertical Developer(s) has the meaning set forth in the Agreement.

Vertical Developer Inclusionary Unit has the meaning given in the definition for Inclusionary Unit.

Vertical Developer Inclusionary Unit Requirement has the meaning set forth in Section 3.2(a).

Vertical Developer Profit has the meaning set forth in Section 3.5 (e).

Vertical Improvements has the meaning set forth in the Agreement.

Section 3 Housing Program.

Up to one thousand six hundred (1,600) Residential Units will be constructed in Phase 1 ("Total Residential Units"). Of the Total Residential Units, approximately three hundred twenty (320) Affordable Residential Units may be constructed on Agency Housing Parcels. In addition, Vertical Developers will construct one thousand two hundred eighty (1,280) Residential Units, as further described in this Program. At least thirty percent (30%) of the Vertical Developer Residential Units in Phase 1 will be For-Rent Units, and approximately seventy percent (70%) will be For-Sale Units. Notwithstanding the above, Vertical Developers, with the Agency's consent, may lease the For-Sale Units on an interim basis, prior to sale, for a lease term of up to one year, not to be extended without the Agency's consent. Such For-Sale Units will continue to be identified as For-Sale Units during the lease term and will be sold as For-Sale Units following the expiration of the lease term. At least fifteen percent (15%) of such For-Rent Units and at least fifteen percent (15%) of such For-Sale Units will be Inclusionary Units, as further described below. In addition, Agency has the option to purchase up to an additional fifteen percent (15%) of Vertical Developer Residential Units, allocated between For-Rent and For-Sale Units in such proportion as Agency in its sole and absolute discretion elects, as described in Section 3.5.

3.1 Declaration of Rental Use Restriction. As soon as practicable after recordation of a final subdivision map for Phase 1, but no later than the first sale to a Vertical Developer of any Lot designated on Exhibit A for For-Rent Residential Units, Developer will record against such Lots a Declaration of Rental Use Restriction substantially in the form attached as Exhibit B. Vertical Developer will promptly provide to Agency copies of the recorded documents, showing the date of recording and document numbers.

3.2 Vertical Developer Inclusionary Unit Requirement.

(a) Allocation. The Vertical Developer Inclusionary Unit Requirement equals fifteen percent (15%) of the Vertical Developer Residential Units constructed in Phase 1, with the fifteen percent (15%) Inclusionary Unit Requirement for each Residential Project, unless Agency and Developer or Vertical Developer agree otherwise. The Inclusionary Units shall be distributed and located, and shall comply with the percentages of total units for each Major Phase, all as shown on Exhibit A.

(b) Affordability.

(1) At least thirty percent (30%) of the Inclusionary Units constructed by Vertical Developers in Phase 1 shall be For-Rent Inclusionary Units. These Units can be

rented at rates no higher than the Program Income Levels for households earning fifty percent (50%) of AMI, less the utility allowance calculated pursuant to schedules and procedures established by the San Francisco Housing Authority.

(2) Approximately seventy percent (70%) of the Inclusionary Units constructed by Vertical Developers in Phase 1 shall be For-Sale Inclusionary Units. These units must be priced such that they are Affordable to households earning no more than eighty percent (80%) of AMI.

(c) Distribution. Distribution of the Inclusionary Units shall be fifteen (15) percent for each Residential Project, unless Agency and Vertical Developer agree otherwise.

(d) Design. The design of the Vertical Developer Inclusionary Units shall be substantially equivalent in size, location, amenities and quality and reflect the mix of Residential Unit sizes and room configurations of, and be dispersed among, the Vertical Developer's Market Rate Residential Units in each Residential Project.

(e) Marketing and Operations Guidelines. The Vertical Developer's obligations with respect to the marketing and operation of the Inclusionary Units, including without limitation the rental rates of Rental Units, sales prices of For-Sale Units, tenant qualifications and reporting requirements and the Vertical Developer's obligations with respect to marketing and occupancy preferences for the Vertical Developer Market Rate Residential Units are described in Exhibit I to this Program.

3.3 Continued Affordability of Inclusionary Units. As soon as practicable after the recordation of a final subdivision map for Phase 1, but in no event later than the first rental of a For-Rent Inclusionary Unit or sale of a For-Sale Inclusionary Unit, the Vertical Developer who owns such Unit will record against such Unit, as applicable, either the Declaration of Restrictions for For-Rent Affordable Housing Units substantially in the form attached as Exhibit C or the Declaration of Restrictions for For-Sale Affordable Housing Units and Option to Purchase Agreement substantially in the form attached as Exhibit D to ensure continued affordability for a ninety (90) year period after the initial lease or sale of the Unit. The Vertical Developer will promptly provide to Agency a copy of the recorded documents, showing the date of recording and document numbers. Any condominium map for each Vertical Developer Residential Project containing Inclusionary Units shall also reflect the above restrictions. Further, the Vertical Developer will convey each For-Sale Affordable Housing Unit. The Vertical Developer will promptly provide to Agency a copy of each recorded grant deed, showing the date of recording and document number. The Owner of the For-Sale Affordable Housing Unit shall execute the Short Form Deed of Trust and Assignment of Rents, the Addendum to Deed of Trust, and the Promissory Note Secured By Deed of Trust, in the forms attached as Attachments to Exhibit D. The Vertical Developer or Owner will promptly provide to Agency a copy of the recorded documents, showing the date of recording and document numbers.

3.4 Disability Access. The Vertical Developer shall comply with all applicable federal, state and local disability access laws, including without limitation the Americans With Disabilities Act, Section 504 of the Rehabilitation Act, the Fair Housing Amendments Act and any other applicable disability access laws. The Vertical Developer is responsible for

determining those disability access laws applicable to the Project. In addition, prior to occupancy of the Project, the Vertical Developer shall provide to the Agency a written reasonable accommodations policy which indicates how the Vertical Developer will respond to requests by disabled individuals for accommodations in Units and common areas of the Project.

3.5 Memorandum of Option; Closing.

(a) Option Units. Agency may purchase up to fifteen percent (15%) of the Phase 1 Vertical Developer Residential Units from Vertical Developers (the "Option Units"), allocated between For-Rent and For-Sale Units in such proportion as Agency in its sole and absolute discretion elects (the "Option"). As soon as practicable after the recordation of the final subdivision map for Phase 1, but in no event later than the first sale of any Lot to a Vertical Developer, Vertical Developer will record against all Lots in the Project Site the Memorandum of Option in the form attached as Exhibit E, evidencing Agency's Option, and promptly provide to Agency a copy of the recorded documents, showing the date of recording and document numbers.

(b) Procedure for Exercise of Option. Promptly after completion of the Design Review and Document Approval Procedure for Vertical Development for each Major Phase containing Residential Units, the Vertical Developer will deliver to Agency a written notice informing Agency of such completion. The notice will include a description of the Residential Units approved (as For-Sale or For-Rent, number of bedrooms, amenities) and a preliminary title report covering the Residential Units issued by the Title Company (the "Title Report"), together with copies of all documents relating to title exceptions showing in the Title Report. Agency will have ninety (90) days after receipt of the notice and other required information to exercise its Option by written notice to the Vertical Developer, specifying in its notice the Residential Units it intends to purchase (the "Option Units"). Agency may exercise its Option, in whole or in part, until such time as Agency has purchased up to fifteen percent (15%) of the total Phase 1 Vertical Developer Residential Units. For each Major Phase including Residential Units constructed by a Vertical Developer, Agency may purchase up to fifteen percent (15%) of the available Vertical Developer Residential Units in that Major Phase.

(c) Due Diligence. During the ninety (90) day period after Agency's receipt of the Vertical Developer's notice and other required information under Section 3.5(b), (i) the Vertical Developer will permit Agency and its designated representatives, at reasonable times and after reasonable notice, to review all non-privileged reports, plans, specifications and other information relating to the approved Residential Units and to inspect the site where the approved Residential Units will be or are being constructed and (ii) Agency may object to any exception shown on the Title Report, other than Permitted Exceptions as set forth in the Agreement or any other liens or encumbrances agreed to by the Agency in the course of Infrastructure or Vertical Improvement development or otherwise contemplated by the Agreement. If Agency fails to so object, then the new exception will be deemed to be a Permitted Exception. If Agency does so object, then the Vertical Developer at its cost will remove any exceptions created by or on behalf of the Vertical Developer prior to the Close of Escrow on the Option Unit, and in its sole discretion may elect to remove any other exception to which Agency objected. If the Vertical Developer does so elect, it will notify Agency within ten (10) days after receipt of Agency's objection. The title exceptions to which Agency did not object, as well as those to which

Agency objected but the Vertical Developer elected not to remove, or which are otherwise permitted hereunder are the "Option Unit Exceptions."

(d) Release of the Option. Within ten (10) days after Agency exercises its Option but in no event later than the initial marketing of Residential Units in such Major Phase, Agency will record against the Units in each Major Phase which are not Option Units a Release of Option Rights in the form attached as Exhibit F, evidencing Agency's release of its Option as to such Units, and promptly provide to the Vertical Developer who owns such Major Phase a copy of the recorded document, showing the date of recording and document number.

(e) Purchase Price. The Agency shall pay the Vertical Developer who owns the Option Unit an "Option Purchase Price" that is the lesser of the price offered to the public or a price comprised of the following:

(1) The Land Cost attributable to each Unit; plus

(2) Actual Direct Costs and Indirect Costs attributable to each Unit;
plus

(3) Vertical Developer fees and profit equal to ten percent (10%) on the sum of Direct and Indirect Costs (the "Vertical Developer Profit").

(f) Time For Payment. Promptly after Complete Construction of an Option Unit, or a number of Option Units for which Complete Construction occurred reasonably contemporaneously, the Vertical Developer will deliver to Agency a written notice of Complete Construction of the Option Units, together with a copy of a recorded final subdivision map for the Major Phase in which the Option Units are located, showing the date of recording and document number, which creates separate legal parcels for each of the Option Units. The notice will include a calculation of the Option Purchase Price, together with schedules substantiating all Land, Direct and Indirect Costs claimed, showing in particular the basis on which Land, Direct and Indirect Costs were allocated to the Units in a particular Major Phase, together with supporting materials, in a form reasonably satisfactory to Agency. Agency may object to such calculation within ten (10) days after receipt, specifying the basis for its objection and its corrected calculation. The parties will negotiate in good faith in an attempt to resolve their differences, but if they are unable to do so within ten (10) days after delivery of Agency's objection, then Closing on the Option Unit will proceed on the basis of the midpoint between the Vertical Developer's and Agency's calculation of the Option Purchase Price and the dispute will be resolved pursuant to the binding arbitration procedure in Section 3.5(q). Agency must pay the Option Purchase Price to the Vertical Developer through Escrow within thirty (30) days after Agency's receipt of Vertical Developer's notice of Complete Construction (the "Close of Escrow"), subject to extensions of such period for any delay caused by Vertical Developer.

(g) Right of Access. After exercise of Agency's Option, Vertical Developer will continue to permit Agency and its designated representatives, at reasonable times and after reasonable notice, to review all non-privileged reports, plans, specifications and other information relating to the Option Units and to inspect the Option Units under construction.

(h) Escrow. Within five (5) Business Days after Complete Construction of each Option Unit or a number of Option Units for which Complete Construction occurred reasonably contemporaneously, Vertical Developer shall establish an escrow ("Escrow") with Chicago Title Company at _____ ("Title Company") and shall notify Agency in writing of the Escrow number and contact person at the same time it delivers the notice specified in Section 3.5(f).

(i) Title Policy. As a condition precedent to Agency's obligation to accept conveyance of the Option Units, the Title Company shall be irrevocably committed to issue to Agency an CLTA owner's title insurance policy with such endorsements, reinsurance and direct access agreements as Agency shall reasonably designate and the Title Company shall accept. The title policy will be in the amount of the Option Purchase Price, and will insure that fee title to the Option Units and all easements appurtenant thereto are vested in Agency, subject only to the Option Unit Exceptions.

(j) Closing Costs and Prorations. Vertical Developer will pay to the Title Company or the appropriate payee thereof transfer taxes, if any, and the Agency shall pay all title insurance premiums. All other closing costs shall be allocated in accordance with the then current custom in the City and County of San Francisco. Ad valorem taxes and assessments, if any, on the Option Units, shall be prorated as of the Close of Escrow. Any such taxes and assessments, including supplemental taxes and escaped assessments, levied, assessed, or imposed for any period up to recordation of the deed, shall be borne by Vertical Developer.

(k) Escrow Instructions. At least fifteen (15) days prior to the date specified for Close of Escrow, each party will furnish the Title Company with appropriate escrow instructions consistent with, and sufficient to implement the terms of, the Option, and will contemporaneously furnish a copy of these instructions to the other party. At least two (2) Business Days prior to the date specified for Close of Escrow, each party will deposit into Escrow all documents it is obligated to deposit under this Option, and at least one (1) Business Day prior to the date specified for Close of Escrow each party will wire transfer into Escrow all funds it is obligated to deposit under this Option.

(l) Deliveries into Escrow.

(1) Agency will deliver into Escrow:

(A) the Option Purchase Price; and

(B) escrow instructions and funds consistent with this Program.

(2) The Vertical Developer will deposit into Escrow:

(A) a standard title company grant deed for each Option Unit in a form approved by Agency, executed by the Vertical Developer in recordable form; and

(B) escrow instructions and funds consistent with this Program.

(m) Conditions Precedent to Closing.

(1) Agency Conditions to Closing. The following are conditions precedent to Agency's obligations with respect to the conveyance of the Option Units, to the extent not expressly waived by Agency by written notice to Vertical Developer:

(A) The Title Company shall be irrevocably committed to issue to Agency title insurance required by Section 3.2(i);

(B) Vertical Developer shall have performed all obligations under this Program required to be performed by Vertical Developer prior to the date for Close of Escrow; and

(C) Vertical Developer shall have delivered to Agency or the Title Company, as applicable, all instructions and documents to be delivered to Agency at Close of Escrow under this Program.

(2) Vertical Developer Conditions to Closing. The following are conditions precedent to Vertical Developer's obligations with respect to the conveyance of the Option Units, to the extent not expressly waived by Vertical Developer by written notice to Agency:

(A) Agency shall have performed all obligations under this Program required to be performed by Agency prior to the date for Close of Escrow; and

(B) Agency shall have delivered to Vertical Developer or the Title Company, as applicable, all instructions and documents to be delivered to Vertical Developer at Close of Escrow under this Program.

(n) Closing. Provided that the conditions to Agency's obligations and the conditions to Vertical Developer's obligations with respect to the Option Units have been satisfied, then on the Close of Escrow on the Option Units, the Title Company will record the deed referenced in Section 3.5(l)(2)(A) in the City's official records, issue the title policy referenced in Section 3.5(m)(1)(C), prorate and pay amounts in accordance with Section 3.5(j) and the escrow instructions, release to Vertical Developer the portion of the Option Purchase Price due to the Vertical Developer and deliver to Agency and the Vertical Developer signed settlement statements.

(o) Expiration of Option. The Agency's Option shall automatically expire and all rights and obligations thereunder shall be released and be of no further force and effect after the Agency purchases the full fifteen percent (15%) of Vertical Developer Residential Units in Phase 1.

(p) Cooperation With Agency Requests. Vertical Developer shall reasonably cooperate with Agency requests to be a co-applicant on any Agency tax credit financing application for the financing of the Option Units described in the Memorandum of Option, provided that such reasonable cooperation shall be at no cost to Vertical Developer and Vertical Developer shall assume no liability whatsoever relating to or arising out of Vertical Developer's being a co-applicant.

3.6 Submissions for Major Phase Approvals.

In order to verify and to track compliance with the Affordable Housing Program, each Vertical Developer shall submit a Major Phase Housing Data Table as part of the application package for each Major Phase including Residential Units. Such Major Phase Housing Data Table shall be in a form mutually agreed upon by the Developer and the Agency and will contain the information described in subsections (a) and (b) below, and as attached in Exhibit G. Agency shall review and approve the Major Phase Housing Data Table in accordance with the procedures set forth in the Design Review and Document Approval Procedure, and development of such Major Phase shall proceed in accordance with such approvals. Agency will cooperate with Vertical Developers in providing the information required to complete the following Tables to the extent known by Agency and not known or reasonably discoverable by the Vertical Developer.

(a) Major Phase Data. The Major Phase Housing Data Table shall identify for the entire Major Phase:

- (1) The total acreage of Vertical Developer Residential Projects;
- (2) The total number of Residential Units proposed;
- (3) The total number of Market Rate Residential Units proposed;
- (4) The total number of Inclusionary Units proposed;
- (5) The allocation of Inclusionary Units among For-Rent and For-Sale Affordable Residential Units for the Major Phase; and
- (6) The location of For-Rent and For-Sale Inclusionary Units within the Major Phase, including a description of such Inclusionary Units in terms of size, number of bedrooms and amenities.

(b) Major Phase Parcel Data. For each parcel identified within a Major Phase, the Major Phase Housing Data Table shall identify the proposed:

- (1) Use (e.g., residential, retail, commercial, office, research and development);
- (2) Parcel acreage;
- (3) Maximum building height;
- (4) Total number of Residential Units; and
- (5) Number of Inclusionary Units, if any.

(c) Major Phase Housing Data Tables for subsequent Major Phases submitted after the first Major Phase Housing Data Table shall include aggregate development data in

relation to the total allowable building program, including the data described above for prior Major Phases adjusted for Residential Projects which have received Schematic Design approval.

3.7 Submissions for Project Approvals.

In order to verify and to track compliance with the Affordable Housing Program, each Developer shall submit a Project Housing Data Table as part of the application package at the time each Residential Project is submitted for its Project Basic Concept Design approval, as described in the Design Review and Document Approval Procedure for Vertical Development. Such Project Housing Data Table shall be in a form mutually agreed upon by the Developer and the Agency, and will contain the information described in subsections (a) and (b) below, and as attached in Exhibit H. The Agency shall review and approve the Project Housing Data Table in accordance with the procedures set forth in the Design Review Document Approval Procedure and development of such Project shall proceed in accordance with such approvals.

(a) Major Phase Data. The Project Housing Data Table shall identify the following information with respect to the entire Major Phase in which such Residential Project is located:

- (1) The total number of allowed Residential Units for the Major Phase;
- (2) The total number of acres and the number of Market Rate Residential Units including, for Residential Projects which have received Schematic Design approval, the number of For-Sale and For-Rent Residential Units, and the number of Inclusionary Units projected for the Major Phase, adjusted for Residential Projects which have received Schematic Design approval;
- (3) The total number of Vertical Developer Residential Units which have received Schematic Design approval, including the allocation of Inclusionary Units between For-Rent and For-Sale Residential Units for each Residential Project;
- (4) The total number of Vertical Developer Residential Units for which Building Permits have been issued;
- (5) The total number of Vertical Developer Residential Units which have received Certificates of Occupancy;
- (6) The total number of Vertical Developer Residential Units for which applications for Schematic Design approval are pending;
- (7) The total number of the remaining Vertical Developer Residential Units allowed for the Major Phase;
- (8) The total number of Inclusionary Units that have been approved in a Residential Project;
- (9) The total number of Inclusionary Units approved in the Major Phase;

(10) The remaining total number of Inclusionary Units to be constructed in the Major Phase; and

(11) The allocation of Inclusionary Units between For-Rent and For-Sale Residential Units;

(12) The total number of Inclusionary Units, and the allocation of For-Sale and For-Rent Inclusionary Units, that have received Certificates of Occupancy.

(b) Project and Parcel Data. For each parcel within the Major Phase, including the subject Residential Project, the Project Housing Data Table shall identify:

(1) The current Owner;

(2) The current development status, including:

(A) Whether a Residential Project within the Major Phase has received Basic Concept Design and Schematic Design approval, and

(B) Whether a Building Permit, Certificate of Occupancy, and/or Certificate of Completion has or have been issued for a Residential Project and the dates thereof;

(3) The use and, if such Vertical Developer Residential Project has received Schematic Design approval, whether it is a For-Sale or For-Rent Residential Project;

(4) The parcel acreage;

(5) The maximum (or, if a Residential Project has already been constructed in that Major Phase, its actual) building height;

(6) The number of Total Vertical Developer Residential Units (for Projects which have received a Schematic Design approval) or the Major Phase approved number of Residential Units if the Project has not received Schematic Design approval;

(7) The number of For-Sale and For-Rent Inclusionary Units for Residential Projects which have received Schematic Design approval, or the number of For-Sale and For-Rent Inclusionary Units for Residential Projects which have not received Schematic Design approval.

Section 4 Agency Affordable Housing Program.

From time to time, the Agency may modify the forms of the documents used to implement its Affordable Housing Program to reflect changes in Agency policy or applicable law, but these changes will not affect the obligations of Vertical Developer as set forth in this Attachment 22.

LIST OF EXHIBITS

- Exhibit A Distribution of Affordable Housing Units**
- Exhibit B Declaration of Rental Use Restriction**
- Exhibit C Declaration of Restrictions for For-Rent Affordable Housing Units**
- Exhibit D Declaration of Restrictions for For-Sale Affordable Housing Units and
Option to Purchase Agreement**
- Exhibit E Memorandum of Option**
- Exhibit F Release of Option Rights**
- Exhibit G Major Phase Housing Data Table**
- Exhibit H Project Housing Data Table**
- Exhibit I Marketing and Operating Obligations**

EXHIBIT A

DISTRIBUTION OF AFFORDABLE HOUSING UNITS

[TO BE ADDED]

EXHIBIT B

DECLARATION OF RENTAL USE RESTRICTION

ATTACHMENT 22

EXHIBIT B

DECLARATION OF RENTAL USE RESTRICTION

Free Recording Requested Pursuant to
Government Code Section 27383

When recorded, mail to:
San Francisco Redevelopment Agency
770 Golden Gate Avenue
San Francisco, California 94102
Attn: Real Estate Division

----- Space Above This Line for Recorder's Use -----

DECLARATION OF RENTAL USE RESTRICTION

THIS DECLARATION OF RENTAL USE RESTRICTION ("Declaration") is made as of _____, 20__ , by _____ [name of Vertical Developer] ("Owner"), in favor of the Redevelopment Agency of the City and County of San Francisco, a public body, corporate and politic, of the State of California ("Agency"). Owner is fee owner of record of that certain real property located in the City and County of San Francisco (the "City"), State of California more particularly described in the attached Attachment A (the "Property").

Section 1. Recitals.

A. The Property is in the City within the Hunters Point Shipyard and is subject to the provisions of the Hunters Point Naval Shipyard Redevelopment Plan adopted by Ordinance No. _____, on _____, 200__. Owner intends to construct on the Property _____ () For-Rent Affordable Housing Units and _____ () For-Rent Market Rate Housing Units (as herein defined).

B. The Agency and Lennar/BVHP, LLC ("Developer") have entered into the Disposition and Development Agreement for Hunters Point, Phase 1, dated _____, 200__, and recorded on in the City's Official Records on _____, 200__, as Document No. _____ (the "Agreement"), including the Affordable Housing Program attached thereto as Attachment 22 (the "Program"), concerning the development of affordable housing units on the Property. The Agreement and Program are on file with the Agency as public records and are incorporated herein by reference. This Declaration is executed and recorded in accordance with the Agreement and the Program, and partially satisfies the requirements therein.

C. The Agency has developed a program to provide home rental opportunities to individuals and families with low incomes by offering homes for rent at rates which are below those otherwise prevailing in the market.

D. The Agency's intent is to preserve the affordability of such homes by restricting the rental.

E. Such homes constitute a valuable community resource. To protect and preserve this resource, it is necessary, proper and in the public interest for the Agency to administer occupancy and rental controls by means of this Declaration.

NOW, THEREFORE, in consideration of the substantial economic benefits inuring to Owner and the public purposes to be achieved under the affordable housing program, Owner and Agency agree as follows:

Section 2. Definitions.

Terms not defined in this Declaration shall have the meanings given to them in the Agreement, including the Affordable Housing Program attached as Attachment 25 thereto.

Affordable Rent means a monthly Rental Rate, including a Utility Allowance in an amount determined by the San Francisco Housing Authority, which does not exceed thirty percent (30%) of fifty percent (50%) of the maximum Area Median Income, based upon Household Size.

Agency has the meaning set forth in the Preamble.

Agreement has the meaning set forth in Section 1.B.

Area Median Income (AMI) has the meaning set forth in the Agreement, as follows: The median income for a household, adjusted solely for Household Size, and not adjusted for other factors, including but not limited to, United States Department of Housing and Urban Development (HUD) high cost adjustments, as determined by HUD for the San Francisco Primary Metropolitan Statistical Area, from time to time.

City has the meaning set forth in the Preamble.

Complete Construction means the point at which Residential Units have been completed in accordance with approved plans and specifications, as reasonably determined by Agency, and a Certificate of Occupancy has been issued for such Residential Units.

Declaration has the meaning set forth in the Preamble.

Developer has the meaning set forth in Section 1.B.

For-Rent Affordable Housing Unit means a Residential Unit that is intended at the time of Complete Construction to be occupied subject to a lease at the Affordable Rent described herein, and not offered for sale.

For-Rent Market Rate Housing Unit means a For-Rent Residential Unit that has no restrictions under this Affordable Housing Program or the Agreement with respect to affordability levels or income restrictions for occupants.

For-Rent Residential Unit means a Residential Unit that is intended at the time of Complete Construction to be occupied subject to a lease, and not offered for sale.

Household Size means the total number of bedrooms in a Residential Unit plus one (1).

Owner has the meaning set forth in the Preamble.

Program has the meaning set forth in Section 1.B.

Property has the meaning set forth in the Preamble.

Rent or Rental Rate means, for each For-Rent Affordable Housing Unit, the total of annual payments for (a) use and occupancy of the Residential Unit and land and facilities associated therewith, (b) any separately charged fees or services assessed by the Owner which are required of all tenants, other than security deposits, (c) a reasonable allowance for utilities which are paid by the tenant, not including telephone service (see definition of Utility Allowance) and (d) any taxes or fees charged for use of the land and facilities other than by the Owner.

Residential Unit means a dwelling unit consisting of a room or suite of two (2) or more rooms that is designed for residential occupancy.

Utility Allowance means, if the cost of utilities (except telephone) and other services for a For-Rent Affordable Housing Unit is the responsibility of the occupying household, an amount equal to the estimate made by the San Francisco Housing Authority or, if not available, the United States Department of Housing and Urban Development, of the monthly costs of a reasonable consumption of such utilities and other services for the Unit by an energy-conservative household of modest circumstances consistent with the requirements of a safe, sanitary and healthful living environment.

Section 3. Rental Use Restriction and Term.

The Residential Project contains _____ () For-Rent Affordable Housing Units and _____ () For-Rent Market Rate Housing Units. All of the For-Rent Affordable Housing Units and For-Rent Market Rate Housing Units on the Property shall be restricted to use and occupancy as For-Rent Residential Units for a continuous period of ninety (90) years after the initial lease of each Residential Unit.

Section 4. Covenants.

The restrictions set forth in this Declaration shall run with the Property and shall be binding on and inure to the benefit of all parties having or acquiring any right, title or interest in the Property and to their successors and assigns.

Section 5. Remedies Cumulative.

Agency's rights and remedies, whether provided by law, in equity or by this Declaration, shall be cumulative, and the exercise of any one or more of such rights or remedies shall not preclude the exercise of any other or further rights or remedies for the same or any other default or breach. No waiver with respect to the performance of any of Owner's obligations shall be effective except to the extent the particular obligation is expressly waived, nor shall it be a waiver with respect to any other rights or remedies of any other of Owner's obligations.

Section 6. Governing Law.

This Declaration shall be governed by and construed in accordance with the internal laws of the State of California.

Section 7. Severability.

Invalidation of any provision of this Declaration, or of its application to any person, by judgment or court order, shall not affect any other provision of this Declaration or its application to any other person or circumstance, and the remaining portions of this Declaration shall continue in full force and effect, unless enforcement of this Declaration as invalidated would be unreasonable or grossly inequitable under all relevant circumstances or would frustrate the fundamental purposes of this Declaration.

IN WITNESS WHEREOF, Owner has executed this instrument the day and year first hereinabove written.

"OWNER"

[name of Vertical Developer]

By: _____

Its: _____

ALL SIGNATURES MUST BE NOTARIZED.

----- Space Below This Line for Acknowledgment -----

STATE OF CALIFORNIA)
) ss.
COUNTY OF _____)

On _____, 20__ before me, the undersigned, a Notary Public in and for said State personally appeared _____, proved to me on the basis of satisfactory evidence to be the person(s) whose name(s) is/are subscribed to the within instrument and acknowledged to me that he/she/they executed the same in his/her/their authorized capacity(ies), and that by his/her/their signature(s) on the instrument the person(s), or the entity upon behalf of which the person(s) acted, executed the instrument.

WITNESS my hand and official seal.

Signature of Notary

(Seal)

Attachment A

PROPERTY DESCRIPTION

[To be provided prior to recordation of the Declaration.]

EXHIBIT C

DECLARATION OF RESTRICTIONS FOR

FOR-RENT AFFORDABLE HOUSING UNITS

ATTACHMENT 22

EXHIBIT C

**DECLARATION OF RESTRICTIONS FOR
FOR-RENT AFFORDABLE HOUSING UNITS**

Free Recording Requested Pursuant to
Government Code Section 27383

When recorded, mail to:
San Francisco Redevelopment Agency
770 Golden Gate Avenue
San Francisco, California 94102
Attn: Real Estate Division

----- Space Above This Line for Recorder's Use -----

**DECLARATION OF RESTRICTIONS FOR
FOR-RENT AFFORDABLE HOUSING UNITS**

THIS DECLARATION OF RESTRICTIONS FOR FOR-RENT AFFORDABLE HOUSING UNITS ("Declaration") is made as of _____, 20__ by _____ [name of Vertical Developer] ("Owner"), in favor of the Redevelopment Agency of the City and County of San Francisco, a public body, corporate and politic, of the State of California ("Agency"). Owner is fee owner of record of that certain real property located in the City and County of San Francisco (the "City"), State of California more particularly described in the attached Attachment A (the "Property").

Section 1. Recitals.

The following recitals of fact are a material part of this Declaration:

A. The Property is in the City within the Hunters Point Shipyard and is subject to the provisions of the Hunters Point Naval Shipyard Redevelopment Plan adopted by Ordinance No. _____, on _____, 200__. Owner intends to construct on the Property _____ () For-Rent Affordable Housing Units and _____ () Market Rate Housing Units (as herein defined).

B. The Agency and Lennar/BVHP, LLC ("Developer") have entered into the Disposition and Development Agreement for Hunters Point, Phase 1, dated _____, 200__, and recorded in the City's Official Records on _____, 200__, as Document No. _____ (the "Agreement"), including the Affordable Housing Program

attached thereto as Attachment 22 (the "Program"), concerning the development of affordable housing units on the Property. The Agreement and Program are on file with the Agency as public records and are incorporated herein by reference. This Declaration is executed and recorded in accordance with the Agreement and the Program, and partially satisfies the Affordable Housing Units requirements therein.

C. The Agency has developed a program to provide home rental opportunities to individuals and families with low incomes by offering homes for rent at rates which are below those otherwise prevailing in the market.

D. The Agency's intent is to preserve the affordability of such homes by restricting the rental.

E. Such homes constitute a valuable community resource. To protect and preserve this resource, it is necessary, proper and in the public interest for the Agency to administer occupancy and rental controls by means of this Declaration.

NOW, THEREFORE, in consideration of the substantial economic benefits inuring to Owner and the public purposes to be achieved under the affordable housing program, Owner and Agency agree as follows:

Section 2. Definitions.

Terms not defined in this Declaration have the meanings given to them in the Agreement, including the Affordable Housing Program attached as Attachment 25 thereto.

Affordable Rent means a monthly Rental Rate, including a Utility Allowance in an amount determined by the San Francisco Housing Authority, which does not exceed thirty percent (30%) of fifty percent (50%) of the maximum Area Median Income, adjusted solely for household size, and not adjusted for other factors, including but not limited to, U.S. Department of Housing and Urban Development's (HUD) high cost adjustments, as determined by HUD for the San Francisco Primary Metropolitan Statistical Area, from time to time.

Agency has the meaning set forth in the Preamble.

Agreement has the meaning set forth in Section 1.B.

Area Median Income (AMI) means the median income for a household, adjusted solely for Household Size, as determined by the United States Department of Housing and Urban Development for the San Francisco Primary Metropolitan Statistical Area, from time to time.

City has the meaning set forth in the Preamble.

Complete Construction means the point at which Residential Units have been completed in accordance with approved plans and specifications, as reasonably determined by Agency, and a Certificate of Occupancy has been issued for such Residential Units.

Declaration has the meaning set forth in the Preamble.

Developer has the meaning set forth in Section 1.B.

For-Rent Affordable Housing Unit means a Residential Unit that is intended at the time of Complete Construction to be occupied subject to a lease at the Affordable Rent described herein, and not offered for sale.

Household Size means the total number of bedrooms in a Residential Unit plus one (1).

Income Certification has the meaning set forth in Section 5 and Attachment B.

Market Rate Housing Unit means a Residential Unit that has no restrictions under this Affordable Housing Program or the Agreement with respect to affordability levels or income restrictions for occupants.

Owner has the meaning set forth in the Preamble.

Program has the meaning set forth in Section 1.B.

Property has the meaning set forth in the Preamble.

Rent or Rental Rate means, for each For-Rent Affordable Housing Unit, the total of annual payments for (a) use and occupancy of the Residential Unit and land and facilities associated therewith, (b) any separately charged fees or services assessed by the Owner which are required of all tenants, other than security deposits, (c) a reasonable allowance for utilities which are paid by the tenant, not including telephone service (see definition of Utility Allowance) and (d) any taxes or fees charged for use of the land and facilities other than by the Owner.

Residential Unit means a dwelling unit consisting of a room or suite of two (2) or more rooms that is designed for residential occupancy.

Utility Allowance means, if the cost of utilities (except telephone) and other services for a For-Rent Affordable Housing Unit is the responsibility of the occupying household, an amount equal to the estimate made by the San Francisco Housing Authority or, if not available, the United States Department of Housing and Urban Development, of the monthly costs of a reasonable consumption of such utilities and other services for the Unit by an energy-conservative household of modest circumstances consistent with the requirements of a safe, sanitary and healthful living environment.

Section 3. Restricted Affordable Housing Units.

3.1 For-Rent Affordable Housing Units. The Residential Project contains _____ () For-Rent Affordable Housing Units, distributed throughout the Residential Project as set forth on the diagram attached hereto as Attachment A-1. The occupancy of all of the For-Rent Affordable Housing Units shall be restricted to housing for low-income households at Affordable Rents.

3.2 Term of Declaration. The For-Rent Affordable Housing Units shall remain available at an Affordable Rent for a continuous period of ninety (90) years after the initial lease of each Unit. The For-Rent Affordable Housing Units shall remain available at an Affordable Rent for the entire ninety (90) year period, regardless of any termination of the Agreement.

Section 4. Lease Terms and Rental Rates.

4.1 Lease Term. The lease term for each For-Rent Affordable Housing Unit and for each Market Rate Housing Unit offered for rent shall not exceed one (1) year. The lease term for each For-Rent Affordable Housing Unit shall be renewable annually only upon the completion of the Income Certification process described in Section 5.

4.2 Rental Rate. The Rental Rate, including the Utility Allowance, for each For-Rent Affordable Housing Unit shall initially be determined based upon Household Size for that Affordable Housing Unit, and then shall be adjusted so that the Rental Rate shall not exceed thirty percent (30%) of fifty percent (50%) of AMI, based upon Household Size.

4.3 Adjustments to Rental Rate. The Rental Rate for For-Rent Affordable Housing Units shall be adjusted, upward or downward, once each year to reflect changes, if any, in the AMI and the Utility Allowance. However, no annual increase shall be greater than the percentage increase during the immediately preceding year, if any, in the AMI, even if the Owner was entitled to increase the Rental Rate in prior years but elected not to do so.

Section 5. Income Certification For Tenants of Affordable Housing Units.

5.1 Initial Income Certification. The Owner shall require all households applying for occupancy of For-Rent Affordable Housing Units to submit an Income Certification at the time of application on the form attached as Attachment B. The Owner shall make reasonable efforts to verify such Income Certifications, including without limitation calling such applicants' employers or other sources of income to confirm the income shown.

5.2 Household Income After Occupancy.

(a) The Owner shall require all households applying for a lease renewal to submit a new Income Certification annually, within sixty (60) days before the expiration date of the current lease on the For-Rent Affordable Housing Unit. The Owner shall make reasonable efforts to verify such Income Certifications, including without limitation calling such applicants' employers or other income sources to confirm the income shown.

(b) Changes in incomes of households occupying For-Rent Affordable Housing Units shall not affect the classification of Residential Units as For-Rent Affordable Housing Units until the household income exceeds one hundred and twenty percent (120%) of AMI. At that point, the lease may be renewed for one additional year, and the household shall be informed that it no longer qualifies and may be subject to non-renewal of such lease at expiration. On or before the ninetieth (90th) day prior to the expiration date of such lease, the Owner shall designate the next available Residential Unit of comparable size within the Residential Project as a replacement For-Rent Affordable Housing Unit, using commercially reasonable efforts to match the

distribution of For-Rent Affordable Housing Units and Market Rate Housing Units shown on Attachment A-1. The Owner shall then restrict the Rent on the replacement For-Rent Affordable Housing Unit to the level specified in Section 4.2 and 4.3, the Residential Unit occupied by the household that no longer qualifies for low-income housing under this Declaration shall no longer be considered a For-Rent Affordable Housing Unit, and the household may execute a new lease on the Residential Unit at the Market Rate. However, if the Owner is unable to designate a replacement For-Rent Affordable Housing Unit on or before the date specified, and the most recent Income Certification shows that the household no longer qualifies for low-income housing under this Declaration, then the Owner shall not renew the household's lease on the For-Rent Affordable Housing Unit. Thereafter, the For-Rent Affordable Housing Unit shall be rented to a low-income household, subject to this Declaration, the Agreement and the Program. The Owner shall keep the household that no longer qualifies for low-income housing reasonably informed of the Owner's attempts to obtain a replacement For-Rent Affordable Housing Unit.

(c) At all times the number of For-Rent Affordable Housing Units in the Residential Project must be at least the number specified in Section 3.1.

Section 6. Records and Reporting Requirements for For-Rent Affordable Housing Units.

6.1 Reports. The Owner shall provide reports regarding the For-Rent Affordable Housing Units to the Agency on a quarterly basis, commencing on the 15th of the month after issuance of a Certificate of Occupancy for the Residential Project, in the form attached hereto as Attachment C, as well as any additional reports or information reasonably requested by the Agency as to the availability, maintenance and operation of the For-Rent Affordable Housing Units and the Residential Project. The report shall separately identify any replacement For-Rent Affordable Housing Units, the For-Rent Affordable Housing Units replaced and any households in the category described in Section 5.2(b) (households whose income has increased to the level that the household no longer qualifies for low-income housing under this Declaration).

6.2 Maintenance of Records. The Owner shall maintain and retain records of all applications, Income Certifications, income verifications, leases, management actions, and rent rolls relating to the For-Rent Affordable Housing Units for five (5) years. The Agency or its designee shall have the right to inspect and copy such records upon reasonable notice during regular business hours.

Section 7. Covenants.

The restrictions set forth in this Declaration shall run with the Property and shall be binding on and inure to the benefit of all parties having or acquiring any right, title or interest in the Property and to their successors and assigns.

Section 8. Remedies Cumulative.

Agency's rights and remedies, whether provided by law, in equity or by this Declaration, shall be cumulative, and the exercise of any one or more of such rights or remedies shall not

preclude the exercise of any other or further rights or remedies for the same or any other default or breach. No waiver with respect to the performance of any of Owner's obligations shall be effective except to the extent the particular obligation is expressly waived, nor shall it be a waiver with respect to any other rights or remedies of any other of Owner's obligations.

Section 9. Governing Law.

This Declaration shall be governed by and construed in accordance with the internal laws of the State of California.

Section 10. Severability.

Invalidation of any provision of this Declaration, or of its application to any person, by judgment or court order, shall not affect any other provision of this Declaration or its application to any other person or circumstance, and the remaining portions of this Declaration shall continue in full force and effect, unless enforcement of this Declaration as invalidated would be unreasonable or grossly inequitable under all relevant circumstances or would frustrate the fundamental purposes of this Declaration.

IN WITNESS WHEREOF, Owner has executed this instrument the day and year first hereinabove written.

“OWNER”

[name of Vertical Developer]

By: _____

Its: _____

ALL SIGNATURES MUST BE NOTARIZED.

----- Space Below This Line for Acknowledgment -----

Attachment A

PROPERTY DESCRIPTION

[To be provided prior to recordation of Declaration.]

Attachment A-1

**DISTRIBUTION OF
AFFORDABLE HOUSING UNITS AND MARKET RATE HOUSING UNITS**

[To be provided prior to recordation of Declaration.]

Attachment B

FORM OF INCOME CERTIFICATION

[To be provided for each Residential Unit prior to recordation of Declaration.]

Attachment C

AFFORDABLE HOUSING UNIT REPORT

[To be provided quarterly for each Residential Project after recordation of Declaration.]

EXHIBIT D

**DECLARATION OF RESTRICTIONS FOR
FOR-SALE AFFORDABLE HOUSING UNITS**

ATTACHMENT 22

EXHIBIT D

LIMITED EQUITY HOME OWNERSHIP PROGRAM

DECLARATION OF RESTRICTIONS FOR FOR-SALE AFFORDABLE HOUSING UNITS AND OPTION TO PURCHASE AGREEMENT

Free Recording Requested Pursuant to Government Code Section 27383

When recorded, mail to: San Francisco Redevelopment Agency 770 Golden Gate Avenue San Francisco, California 94102 Attn: Housing Division, attn: Harriet Starkes [site address]

----- Space Above This Line for Recorder's Use -----

LIMITED EQUITY HOME OWNERSHIP PROGRAM

DECLARATION OF RESALE RESTRICTIONS AND OPTION TO PURCHASE AGREEMENT

Section 1. Parties.

THIS DECLARATION OF RESALE RESTRICTIONS AND OPTION TO PURCHASE AGREEMENT ("Declaration") is made as of _____, 20__, (the "Effective Date") by and between _____ as _____ [indicate manner in which owner takes title] ("Owner") and the Redevelopment Agency of the City and County of San Francisco, a public body, corporate and politic, of the State of California ("Agency"). Owner is purchasing that certain real property in the City with a street address of _____, San Francisco, California _____, and more particularly described on Exhibit A to the Grant Deed ("Property"). Capitalized terms used in this Declaration have the meanings given to them in Section 4 below.

Section 2. Recitals.

The following recitals of fact are a material part of this Declaration:

- (a) The Agency has developed a program to provide home ownership opportunities to individuals and families with low and moderate incomes by offering homes for sale at prices which are below those otherwise prevailing in the market;

(b) The Agency's intent is to preserve the affordability of such homes by restricting the resale price;

(c) Such homes constitute a valuable community resource; and

(d) It is necessary, proper and in the public interest for the Agency to protect and preserve this resource by administering occupancy and resale controls by means of this Declaration.

NOW, THEREFORE, in consideration of the substantial economic benefits inuring to Owner and the public purposes to be achieved under the affordable housing program, Owner and the Agency agree as follows:

Section 3. Owner's Affordable Purchase Price.

The Owner's Affordable Purchase Price for the Property described in Section 1, above, is \$ _____. This purchase price is based on a five percent (5%) down payment and a rate for a thirty (30) year fixed mortgage based on a ten (10) year rolling average of rates published in the Wall Street Journal, with a total of annual payments for principal, interest, taxes, assessments and homeowner's association dues which does not exceed thirty-three percent (33%) of the AMI for Household Size.

Section 4. Definitions.

As used in this Declaration, the capitalized terms set forth below shall have the following meanings:

(a) "Addendum to Deed of Trust" means the supplemental document to the Deed of Trust, executed by a Qualified Purchaser in favor of the Agency, in the form attached as Attachment C.

(b) "Affordable Purchase Price" for Owner is defined in Section 3.

(c) "Agency" is defined in Section 1.

(d) "Agency Note" is the promissory note executed by Owner in favor of the Agency, which is secured by a Deed of Trust executed by Owner in favor of the Agency, in the form attached as Attachment A.

(e) "Area Median Income" ("AMI") means the median income for a household, adjusted solely for Household Size, residing in the City, as determined by the Agency pursuant to publications issued by the United States Department of Housing and Urban Development for the San Francisco Primary Metropolitan Statistical Area, from time to time.

(f) "Broker" means a real estate broker licensed by the State of California Department of Real Estate and approved by the Agency to assist Owner in identifying Qualifying Purchasers for the Transfer of the Property.

(g) "Buyer Acknowledgement" means the acceptance of terms and conditions of this Exhibit D, in the Loan Disclosure Information form attached as Attachment F.

(h) "Capital Improvements" is defined in Section 10.1.

(i) "Catastrophic Illness" means an illness or injury that incapacitates Owner for an extended period of time, or that incapacitates a member of Owner's family, which incapacity requires Owner to take time off from work for an extended period to care for that family member, and taking extended time off from work creates a financial hardship for Owner because he or she has exhausted all of his or her sick leave and other paid time off.

(j) "Certificate Holder" means those households with a valid Certificate of Preference issued by the Agency that entitles the holder to receive preference in consideration for housing due to displacement by prior redevelopment activities.

(k) "City" means the City and County of San Francisco.

(l) "Closing Costs" means the reasonable and customary costs incurred by Owner in transferring the Property.

(m) "Damage" means deficiencies in the Property occurring during Owner's ownership of the Property, including without limitation: (1) violations of applicable building, plumbing, electric, fire or housing codes; (2) needed repair to appliances furnished to Owner upon purchase of the Property; (3) holes and other defects (except for holes from picture hangers) in walls, ceilings, floors, doors, windows, screens, carpets, drapes, countertops and similar appurtenances; and (4) repairs needed, as determined by Agency, to put the Property into saleable condition, including without limitation cleaning and painting.

(n) "DDA" is defined in Section 5.1.

(o) "Declaration" is defined in Section 1.

(p) "Deed of Trust" means one or more Deeds of Trust on this Property, executed by Owner in favor of the Agency, substantially in the form attached as Attachment B.

(q) "Developer" is defined in Section 5.1.

(r) "Domestic Partner" means any person who has or enters into a domestic partnership currently registered with a governmental body pursuant to State or local law authorizing such registration.

(s) "Down Payment Assistance Loan" is a loan of down payment funds made by the Agency to Owner for purchase of the Property.

(t) "Effective Date" is defined in Section 1.

(u) "Events of Default" are defined in Section 11.1.

(v) "Fair Market Value" means the cash purchase price for the Property that a willing buyer would pay to a willing seller at the time of sale, neither being under a compulsion to buy or sell, as determined by an independent, MAI-certified appraiser who has experience in residential appraisals in San Francisco.

(w) "Household Size" means the number of persons for whom the Property will be a Principal Residence. The Affordable Purchase Price shall be established by using a Household Size which assumes occupancy by one person for one-bedroom units. For two-bedroom and larger units, the assumption is occupancy by one person per bedroom plus one.

(x) "Grant Deed" is defined in Section 8.1(b).

(y) "Gross Annual Income" means pre-tax money earned annually by a household including overtime pay, commissions, dividends, and any other source of income.

(z) "Income Certification" has the meaning set forth in Section 7.1 and is substantially in the form attached as Attachment D.

(aa) "Notice" is defined in Section 13.4.

(bb) "Notice of Proposed Transfer" is defined in Section 7.1.

(cc) "Occupancy Certificate" is defined in Section 13.3.

(dd) "Owner" is defined in Section 1, and upon Owner's death includes the personal representative administering the Owner's estate.

(ee) "Owner's Proceeds" means the amount due to Owner upon Transfer of the Property to a Qualifying Purchaser or upon exercise of the Agency's Purchase Option, according to the terms of this Declaration.

(ff) "Permitted Exceptions" means those title exceptions that are listed on Attachment E.

(gg) "Principal Residence" means the location at which an individual resides for at least ten (10) months out of each calendar year or such shorter period of time as the Agency, in its sole discretion, shall determine.

(hh) "Property" is defined in Section 1.

(ii) "Purchase Option" is defined in Section 9.1.

(jj) "Purchase Option Assignee" is defined in Section 9.3.

(kk) "Qualifying Purchaser" means persons and families who are first time homebuyers as defined in Internal Revenue Service Code Section [] and approved by the Agency whose Gross Annual Income, adjusted for Household Size, does not exceed _____ percent (___%) of Area Median Income.

(ll) "Repair Costs" means the costs to repair Damage to the Property.

(mm) "Resale Affordable Price" means a purchase price which is affordable to a household earning _____ percent (____%) of current Area Median Income, adjusted for a Household Size of _____ persons, using a _____ percent (____%) down payment and a commercially reasonable thirty (30)-year fixed mortgage with commercially reasonable rates, points and fees, and with a total annual payment for principal, interest, taxes, insurance and homeowner's association dues which does not exceed thirty-three percent (33%) of the household's Gross Annual Income.

(nn) "Senior Lender" means a bank, savings and loan association, insurance company, pension fund, publicly traded real estate investment trust, governmental agency, or charitable organization engaged in making loans which customarily makes residential purchase money loans and has loaned money to Owner or a Qualifying Purchaser to purchase or refinance the purchase of the Property.

(oo) "Senior Lien" means a single deed of trust for the purpose of securing a loan from the Senior Lender to finance or refinance the purchase of the Property.

(pp) "Transfer" means any voluntary or involuntary sale, assignment or transfer of any interest in the Property.

(qq) "Unauthorized Transfer" is defined in Section 11.1(a).

(rr) "Vertical DDA" is defined in Section 5.1.

(ss) "Vertical Developer" is defined in Section 5.1.

Section 5. Related Documents.

5.1 Disposition and Development Agreement. The Agency and Lennar/BVHP, LLC ("Developer") entered into that certain Disposition and Development Agreement for Hunters Point, Phase 1, dated for reference purposes only as of _____, 20____ and recorded on _____, 20____ as Document No. _____ in the City's Official Records ("DDA"), including the Affordable Housing Program attached thereto as Attachment 22 (the "Housing Program"), concerning the development of affordable housing units. As provided in the DDA and Housing Program, this Declaration in turn became part of the [describe Vertical DDA], dated for reference purposes only as of _____, 20____ and recorded on _____, 20____ as Document No. _____ in the City's Official Records (the "Vertical DDA") and was imposed on the [describe "Vertical Developer"]. The DDA, Vertical DDA and the Housing Program are on file with the Agency as public records and are incorporated herein by reference. Under the DDA, the Vertical DDA and the Housing Program, the Property is income and price restricted to be affordable to persons or households earning not more than _____ percent (____%) of Area Median Income. This Declaration is being executed and recorded in accordance with the DDA, the Vertical DDA and the Housing Program, and partially satisfies the requirements therein.

5.2 Hunters Point Naval Shipyard Redevelopment Plan. The Property is in the City, within the Hunters Point Shipyard, and is subject to the provisions of the Hunters Point Naval Shipyard Redevelopment Plan adopted by Ordinance No. _____, on _____, 200____.

5.3 Agency Note and Deed of Trust. Owner executed an Agency Note in favor of Agency, dated _____, 20___, secured by a Deed of Trust and Addendum to Deed of Trust on the Property.

Section 6. Affordable Restrictions.

6.1 Restrictions. Owner shall own and occupy the Property as Owner's Principal Residence, and Owner shall not lease the Property, or any portion thereof, without the Agency's prior written consent. Owner shall submit to the Agency on an annual basis a certification that Owner has occupied the Property as Owner's Principal residence for at least ten (10) months in the preceding year.

6.2 Term. This Declaration shall remain in effect for forty-five (45) years from the Effective Date until such time as the Property is Transferred pursuant to the terms of this Declaration, at which time a declaration with the same form and substance as this Declaration shall become effective for forty-five (45) years from the effective date of such declaration. Upon the expiration of this Declaration due to completion of the 45-year Term, Owner must repay to the Agency the difference between the Resale Affordable Price and the Fair Market Value, as determined at the completion of the Term. In lieu of this payment to the Agency, Owner may renew the Term of this Agreement for an additional forty-five (45) years.

6.3 Owner Representations and Warranties. In applying to purchase the Property, Owner submitted an Income Certification on the form attached as Attachment D. Owner acknowledges that reasonable efforts may be made to verify such Income Certification, including without limitation calling Owner's employers or other sources of income to confirm the income shown. Owner represents and warrants to the Agency that the Income Certification and any financial and other information Owner previously provided to Agency for the purpose of qualifying to purchase the Property was true and correct at the time it was given and remains true and correct as of the date of this Declaration.

Section 7. Transfer Procedures.

7.1 Notice of Proposed Transfer. Except as provided in Sections 7.5 and 7.6(a), if Owner desires to Transfer the Property, Owner shall deliver written notice to Agency ("Notice of Proposed Transfer"), and Agency shall calculate the Resale Affordable Price and notify Owner of the same.

7.2 Priority to Certificate Holders. An Owner may transfer the Property only to a Qualifying Purchaser or the Agency. The Agency shall give notice to Certificate Holders who shall have priority in purchasing the Property over all other Qualified Purchasers, except for transferees under Section 7.5 and 7.6(a) and the Agency. If no Certificate Holders express interest in purchasing the Property or are not otherwise qualified, then Owner shall market the Property as set forth in Section 7.3 below.

7.3 Marketing the Property. Owner shall work with Broker to locate a Qualifying Purchaser for Transfer of the Property at the Resale Affordable Price. Owner and Broker shall use diligence and good faith in marketing the Property as evidence by all of the following:

- Listing the Property on the MLS Listing;
- Advertising the Property in the Real Estate section of at least two (2) newspapers of general circulation in the City;
- Conducting at least two (2) open houses of the Property; and
- Requesting that the Agency list the Property on the Agency's website.

If Owner and Broker, acting diligently and in good faith, are unable to locate a Qualifying Purchaser after one hundred and fifty (150) days from the date of Agency's receipt of the Notice of Proposed Transfer, then the percentage of AMI defining Qualifying Purchasers shall be increased to 150% of the AMI defined in Section 4(kk). The Resale Affordable Purchase Price shall remain the same.

7.4 Inspection. Within thirty (30) days after the Agency's receipt of the Notice of Proposed Transfer, Agency shall have the right to enter and inspect the Property. The Agency shall give Owner twenty-four (24) hours prior written notice before conducting an inspection. The Agency may inspect the Property to determine if any Damage exists. In the event any Damage is noted, the Agency shall determine the Repair Costs and shall deliver written notice to Owner specifying the Damage and the Repair Costs. Owner shall either: (a) repair the Damage at Owner's cost, or (b) cause the escrow agent at closing to pay the Repair Costs to Agency from Owner's Proceeds, as provided in Section 8.3. If Owner elects to repair the Damage, the Agency shall have the right to re-inspect the Property under the terms of this Section 7.4 after the repairs are complete. If the Agency determines in the Agency's sole discretion that Damage still remains, Owner shall cause the escrow agent at closing to pay the remaining Repair Costs to the Agency, but only to the extent such funds are available after payment of the Senior Lien. If Owner elects to repair the Damage, all repairs and the re-inspection shall be completed without extending the closing date, unless extended by mutual written agreement of both the Agency and Owner.

7.5 Transfer to Spouse or Domestic Partner. If an Owner marries or becomes a Domestic Partner after purchasing the Property, the spouse or Domestic Partner may become a co-Owner. An Owner intending to add a spouse or Domestic Partner as a co-Owner must present his or her marriage certificate or Domestic Partnership registration to the Agency for review, and the proposed co-Owner shall execute an addendum to this Declaration and any other Agency documents related to the Property by which the co-Owner shall assume the same rights and responsibilities with respect to those documents as the Owner.

7.6 Transfer Upon Owner's Death.

(a) Upon Owner's death, the Property may be Transferred to any co-Owner previously approved by the Agency without further Agency approval, but such co-Owner shall notify Agency within thirty (30) days of the Transfer.

(b) Upon the death of Owner and all Agency approved co-Owners, the Property may be Transferred by inheritance, will, or any other function of law to a Qualifying Purchaser. The proposed transferee shall submit an Income Certification, in the form attached as Attachment D, and any other information reasonably requested by the Agency to verify that the proposed

transferee meets the requirements for a Qualifying Purchaser. The Agency shall have forty-five (45) days after receipt of all required information to determine whether the proposed transferee is a Qualifying Purchaser. If the Agency determines that the proposed transferee is a Qualifying Purchaser, the Property may be Transferred to the proposed transferee for no consideration. The proposed transferee shall execute a new Declaration and any other Agency documents related to the Property by which the proposed transferee shall assume the same rights and responsibilities with respect to those documents as the Owner. If the Agency determines that the proposed transferee is not a Qualifying Purchaser, the Property shall be Transferred pursuant to Sections 7.1 – 7.4, inclusive.

Section 8. Closing.

8.1 Conditions to Closing. Except as provided in Sections 7.5, 7.6(a) and Transfers by foreclosure or the Senior Lender’s acceptance of a deed in lieu of foreclosure, all Transfers shall take place through an escrow with a mutually acceptable escrow company. It shall be a condition to closing, other than a Transfer to a co-Owner pursuant to Sections 7.5 or 7.6(a), that the escrow agent involved in the closing has received the following:

(a) Written confirmation from the Agency of the Resale Affordable Price and either (i) the identity of the Qualifying Purchaser or (ii) notification that the Agency is exercising the Purchase Option;

(b) A standard title company form grant deed, executed and acknowledged by Owner (or the Agency as attorney in fact for Owner) granting the Property to the Qualifying Purchaser (“Grant Deed”), which shall be recorded in the City’s Official Records;

(c) A declaration with the same form and substance as this Declaration executed and acknowledged by the Qualifying Purchaser and the Agency, which shall be recorded in the City’s Official Records;

(d) An Agency Note secured by a Deed of Trust and Addendum to Deed of Trust, executed by the Qualifying Purchaser on the Agency’s standard forms, attached as Attachment A, Attachment B and Attachment C, which Deed of Trust and Addendum shall be recorded in the City’s Official Records; and

(e) A signed copy of the Buyer Acknowledgement contained in the Loan Disclosure Information, attached as Attachment F.

8.2 Closing Procedures For Sale to Qualifying Purchaser. At closing, Owner shall convey the Property to the Qualifying Purchaser by Grant Deed. Owner shall cause a mutually acceptable title company to issue to the Qualifying Purchaser a CLTA standard coverage owner’s form of title insurance policy in the amount of the Resale Affordable Price insuring title to the Property vested in the Qualifying Purchaser, subject only to standard printed form exceptions, the Agency’s Deed of Trust and exclusions, liens for current taxes and assessments not yet due or payable, the new declaration and such other matters as were exceptions to title as of _____ [date of sale to first Owner] or are accepted by the Qualifying Purchaser in writing, as set forth in Attachment E. All closing costs and title insurance premiums shall be paid pursuant to the custom in the City.

8.3 Owner's Proceeds. The value of the Owner's Proceeds from a Transfer of the Property shall be calculated as follows. Owner's Proceeds equal:

- (a) The Resale Affordable Price;
- (b) Less the amount necessary to release the Senior Lien;
- (c) Less Closing Costs;
- (d) Less any Repair Costs due to the Agency pursuant to Section 7.4;
- (e) Plus the amortized value of Capital Improvements.

8.4 Resale Affordable Price. Notwithstanding anything in Section 4(mm) to the contrary, if the Resale Affordable Price is less than the original value of the Senior Lien, then the Agency may increase the percentage of AMI defined in Section 4(mm) to a level sufficient to allow for a Resale Affordable Price which covers the original value of the Senior Lien, up to a maximum of one hundred and twenty percent (120%) of AMI. If, after adjustment of the Resale Affordable Price described above, if any, the Resale Affordable Price is less than the sum of the Owner's Affordable Purchase Price plus the Closing Costs, then the Agency through its Executive Director as authorized in Resolution No. [_____] dated [_____] shall deposit into escrow the funds necessary to cover the Owner's original down payment funds and Closing Costs. Such deposit into escrow shall be in addition to the Agency's deposit into escrow of the amortized value of the Capital Improvements. After such adjustment, the value of the Owner's Proceeds shall be calculated according to Section 8.3.

Section 9. Agency's Purchase Option.

9.1 Grant of Option. Owner grants to Agency an option to purchase the Property upon the occurrence of an Event of Default under Section 11.1 ("Purchase Option").

9.2 Exercise of Option. Agency may exercise the Purchase Option as follows:

(a) If the Purchase Option is triggered as a result of an Event of Default under Sections 11.1(a) – (d), then the Agency may exercise the Purchase Option within ninety (90) days after the Agency gives written notice of default to Owner.

(b) If the Purchase Option is triggered as a result of Owner's default under the Senior Lien as defined in Section 11.1(e), then the Agency may exercise the Purchase Option by giving written notice to Owner and Senior Lender, at any time prior to the first to occur of: (i) five (5) business days before the date of a foreclosure sale under the Senior Lien pursuant to California Civil Code § 2924f, as the same may be postponed from time to time; (ii) five (5) business days after Agency's receipt of notice from the Senior Lender that a court intends to enter a decree of foreclosure of the Senior Lien in an action under California Code of Civil Procedure § 726; or (iii) five (5) business days after the Agency's receipt of notice from Senior Lender that Senior Lender intends to enter into a deed in lieu of foreclosure of the Property.

9.3 Assignment of Purchase Option. Prior to or after exercise of the Purchase Option, the Agency may assign the Purchase Option to a governmental agency, non-profit organization, or a Qualifying Purchaser ("Purchase Option Assignee"), who shall be subject to this Declaration.

9.4 Grant of Power of Attorney. Owner hereby grants to the Agency an irrevocable power of attorney coupled with an interest to act on Owner's behalf to execute, acknowledge and deliver any and all documents relating to the Purchase Option.

9.5 Non-Liability of Agency. The Agency shall not be held liable by reason of its exercise or non-exercise of the Purchase Option.

Section 10. Capital Improvements; Maintenance.

10.1 Capital Improvements. A "Capital Improvement" is a permanent improvement to the Property made during Owner's ownership of the Property which: (a) has a value in excess of one-half of one percent (0.5%) of the Affordable Purchase Price originally paid by Owner but less than ten percent (10%) of the Affordable Purchase Price originally paid by Owner; (b) has a useful life of greater than five (5) years subsequent to the proposed Transfer by Owner; and (c) has been made with all required permits and approvals, including without limitation homeowner's association and governmental approvals obtained prior to the construction or installation of the Capital Improvement(s).

10.2 Credits for Capital Improvements. Owner shall receive credit at the time of Transfer for Capital Improvements made to the Property as follows:

(a) At least thirty (30) days prior to the date of Transfer, Owner shall deliver to the Agency a list of the Capital Improvement(s), if any, made to the Property. The Agency shall determine whether the proposed improvements qualify as Capital Improvement(s), as defined in Section 10.1.

(b) The value of Capital Improvements shall equal the sum of all Capital Improvements with each improvement amortized by a factor of seven percent (7%) per year from the date of the Capital Improvement's completion.

10.3 Maintenance. Owner shall not destroy or damage the Property, allow the Property to deteriorate, or commit waste on the Property. Owner shall maintain the Property in compliance with all applicable laws, ordinances and regulations and in a good and clean condition and all appliances and fixtures shall be in good working order.

Section 11. Default and Remedies.

11.1 Events of Default. The occurrence of any one of the following events or circumstances shall constitute an "Event of Default" by Owner under this Declaration.

(a) Owner has actually Transferred or attempted to Transfer the Property in violation of the covenants and restrictions contained in this Declaration ("Unauthorized Transfer").

(b) The Agency has determined in the Agency's sole discretion that the Property is not Owner's Principal Residence.

(c) Owner fails to pay real estate taxes, assessments or homeowner's association dues, when due or Owner fails to maintain insurance in such amounts as required under this Declaration; or Owner places any mortgages, encumbrances or liens upon the Property in violation of this Declaration; and such event or condition shall not have been cured within thirty (30) days following the date of written notice to cure by the Agency to Owner.

(d) Owner fails to perform any other agreements or obligations on Owner's part to be performed under this Declaration, and such failure continues for thirty (30) days following the date of written notice to cure by the Agency to Owner, or in the case of a default not susceptible of cure within thirty (30) days, Owner fails to promptly commence such cure within thirty (30) days and thereafter fails to diligently prosecute such cure to completion.

(e) Owner causes or permits a default under the Senior Lien and fails to cure the same in accordance with the cure provisions in the Senior Lien

(f) Owner is in default of a term of the Agency Note and/or the Deed of Trust.

11.2 Remedies. Upon the occurrence of an Event of Default by Owner, Agency may exercise any or all of the remedies set forth below:

(a) Agency shall have the right to exercise the Purchase Option;

(b) Agency shall have the right to institute an action for specific performance of the terms of this Declaration, for an injunction prohibiting a proposed Transfer in violation of this Declaration, or for a declaration that a Transfer is void; and

(c) Agency shall have the right to institute an action for foreclosure on its Deed of Trust and/or to accept a deed in lieu of foreclosure.

(d) Agency shall have the right to exercise all other remedies permitted by law or at equity.

Section 12. Lender Provisions.

12.1 Purposes of Financing. Subject to the Agency's prior written approval, Owner may encumber title to the Property for the sole purpose of securing (a) purchase money financing, (b) refinancing (but only up to the amount of the original financing), or (c) refinancing up to the amount of the original financing, plus fifty percent (50%) of the value of the Resale Affordable Price less the Owner's Affordable Purchase Price. Refinancing under option (c), above, shall be permitted only for making Capital Improvements to the Property, meeting post-secondary educational expenses incurred by a household member after the date of purchase, meeting the costs of an Owner's or Owner's immediate family member's Catastrophic Illness, or securing funds required to implement a dissolution of marriage or domestic partnership agreement. Owner shall not cause or permit any other mortgages, encumbrances or liens upon

the Property. Owner shall submit to the Agency on an annual basis a certification that Owner has not refinanced the Property in violation of this Section 12.1.

12.2 Subordination. The Agency shall subordinate this Declaration to the Senior Lien by execution of Agency's standard form subordination agreement, or some other form of agreement mutually acceptable to Agency and Senior Lender.

12.3 Default and Foreclosure. Owner shall provide a copy of any notice of default under the Senior Lien to the Agency within three (3) days of Owner's receipt. In the event of any default under the Senior Lien, Agency, in addition to any other rights and remedies it may have under this Declaration, at law or in equity, shall have the right to:

- (a) cure such default pursuant to Section 12.4;
- (b) exercise its Purchase Option pursuant to Section 9.2(b); or
- (c) foreclose its Deed of Trust on the Property.

Agency's rights under this Section 12.3 shall not prevent the Senior Lender from commencing a judicial or nonjudicial foreclosure of the Senior Lien. If the Agency, in its sole discretion, does not act pursuant to Sections 12.3(a-b) above, and the Senior Lender acquires the Property through foreclosure or acceptance of a deed-in-lieu of foreclosure, future sales of the Property shall not be subject to the resale restrictions provided herein.

12.4 Right to Cure. Although the Agency has no obligation to do so, the Agency may perform any act required of Owner in order to prevent a default under, or an acceleration of the indebtedness secured by, the Senior Lien or the commencement of any foreclosure or other action to enforce the collection of such indebtedness. If the Agency elects to cure any such default, Owner shall pay the expenses incurred by the Agency in effecting any cure upon demand within thirty (30) days, together with the interest thereon at the maximum interest rate permitted by law. Failure of Owner to timely reimburse the Agency shall constitute an Event of Default under Section 11.1(d).

Section 13. Miscellaneous.

13.1 Damage and Destruction; Condemnation; Insurance. If the Property is condemned or the improvements located on the Property are damaged or destroyed, all proceeds from insurance or condemnation shall be distributed in accordance with this Section 13.1, subject to the requirements of the Senior Lien. Insurance shall be maintained in the types and amounts required under the Senior Lien. Unless Owner, the Agency, and Senior Lender otherwise agree in writing, insurance proceeds shall be applied to restore or repair the Property damaged. If Owner, the Agency and Senior Lender determine that restoration or repair cannot be made, or if the Property is condemned, the insurance or condemnation proceeds shall first be allocated to pay the outstanding value of the Senior Lien and all associated fees of the Senior Lender, with the balance distributed between the Owner and Agency as follows. The proceeds attributable to the Property shall be multiplied by a fraction. The numerator is the Resale Affordable Price as calculated under this Declaration and the denominator is the Fair Market Value of the Property

hereof. Any representations, warranties, promises, or conditions, whether written or oral, not specifically and expressly incorporated in this Declaration, shall not be binding on any of the parties, and Owner and the Agency each acknowledge that they have not relied, in entering into this Declaration, on any representation, warranty, promise or condition, not specifically and expressly set forth in this Declaration. All prior discussions and writings have been, and are, merged and integrated into, and are superseded by, this Declaration.

13.8 Severability. In the event that any provision of this Declaration is determined to be illegal or unenforceable, such determination shall not affect the validity or enforceability of the remaining provisions hereof, all of which shall remain in full force and effect.

13.9 Successors and Assigns. This Declaration shall be binding upon and inure to the benefit of the successors and assigns of the Agency. The Agency may assign or transfer its rights under this Declaration upon thirty (30) days written notice to Owner. It is expressly agreed by Owner that Owner may assign his or her rights to this Declaration only by Transfer pursuant to Section 7 or by the Agency's exercise of the Purchase Option pursuant to Section 9.

13.10 Headings. The headings within this Declaration are for the purpose of reference only and shall not limit or otherwise affect any of the terms of this Declaration.

13.11 Time for Performance. Time is of the essence in the performance of the terms of this Declaration. All dates for performance (or cure) shall expire at 5:00 p.m. on the performance or cure date. Any performance date which falls on a Saturday, Sunday or Agency holiday is automatically extended to the next Agency working day.

13.12 Amendments. Any modification or waiver of any provision of this Declaration or any amendment thereto must be in writing and signed by a person or persons having authority to do so, on behalf of both the Agency and Owner.

13.13 Controlling Agreement. Owner covenants that Owner has not executed and will not execute any other agreement with provisions contradictory to or in opposition to the provisions of this Declaration. Owner understands and agrees that this Declaration shall control the rights and obligations between Owner and the Agency.

13.14 Governing Law. This Declaration shall be governed by, and construed and enforced in accordance with, the internal laws of the state of California.

13.15 Recordation. Owner shall cause this Declaration to be recorded in the City's Official Records.

IN WITNESS WHEREOF, Owner and the Agency have executed this Declaration as of the date written above.

AGENCY:

Redevelopment Agency of the City and
County of San Francisco

OWNER:

By: _____

Ayisha Benham
Deputy Executive Director
Finance and Administration

ALL SIGNATURES MUST BE NOTARIZED.

----- Attach All Purpose California Notary Acknowledgment -----

APPROVED AS TO FORM:

SAN FRANCISCO REDEVELOPMENT AGENCY

By: _____

James Morales
Agency General Counsel

Attachment A

PROMISSORY NOTE SECURED BY DEED OF TRUST

Date: _____

San Francisco, California

THIS NOTE MAY NOT BE PREPAID

FOR VALUE RECEIVED, the undersigned _____ (“Debtor”), promises to pay to the Redevelopment Agency of the City and County of San Francisco, a public body, corporate and politic, of the State of California, (“Holder” or “Agency”), at 770 Golden Gate Avenue, 3rd Floor, San Francisco, California 94102, or any other place designated in writing by Holder to Debtor, the amount calculated under the formula stated in this Promissory Note (“Note”).

Debtor and Holder executed a Declaration of Resale Restrictions and Option to Purchase Agreement (“Declaration”), dated the same date as this Note, which, in part, establishes the rights and obligations of the Debtor and Holder in the event Debtor desires to Transfer the real property described in the Declaration (the “Property”). “Transfer” means any voluntary or involuntary sale, assignment or transfer of any interest in the Property.

Debtor obtained a loan (“Senior Lien”) from _____ (“Senior Lender”), which loan is secured by a first deed of trust lien on the Property (“First Deed of Trust”). The Declaration and this Promissory Note are subordinate to the Senior Lien.

This Note is secured by a Second Deed of Trust, dated the same date as this Note, executed by Debtor in favor of Holder, with _____ as Trustee, which secures the payment of the debt evidenced by this Note, and all renewals, extensions and modifications of the Note (“Agency’s Deed of Trust”).

Capitalized terms used herein and not defined shall have the meanings set forth in the Declaration or in Agency’s Deed of Trust, as applicable.

Upon Debtor’s actual, attempted or pending Transfer of the Property other than as permitted under the Declaration, or upon default under the Senior Lien (the “Trigger Date”), Debtor shall pay to Holder:

- a. The difference between (1) the Fair Market Value of the Property as of the Trigger Date and (2) the Resale Affordable Purchase Price as of the Trigger Date, had such Transfer been executed in accordance with the Declaration. Fair Market Value shall be determined by an appraisal of the Property. The appraiser shall be an independent, MAI-certified appraiser who has experience in residential appraisals in San Francisco, and shall be selected by Holder; plus
- b. Any amounts disbursed by Holder under Section 5 of the Deed of Trust to protect Holder’s rights in the real property described in the Declaration and Deed of Trust; plus

- c. Commencing from the Trigger Date, interest on the amounts due at an annual rate of 10%, compounded.

With or without the filing of any legal action, proceeding or appeal, or appearance in any bankruptcy proceeding, Debtor agrees to pay on demand, together with interest at the above rate from the date of such demand until paid, all reasonable attorneys' fees, costs of collection, costs, and expenses incurred by Holder in connection with the defense or enforcement of this Note and the Deed of Trust.

No previous waiver and no failure or forbearance by Holder in acting with respect to the terms of this Note or the Deed of Trust shall constitute a waiver of any breach, default, or failure of condition under this Note, the Deed of Trust, or the Declaration. A waiver of any term of this Note, the Deed of Trust, or the Declaration must be made in writing, signed by both parties, and shall be limited to the express written terms of such waiver. In the event of any inconsistencies between the terms of this Note and the terms of any other document related to the debt evidenced by this Note, the terms of this Note shall prevail.

If this Note is executed by more than one person as Debtor, the obligations of each such person shall be joint and several, and each shall be primarily and directly liable hereunder. Debtor waives presentment, demand, notice of dishonor, notice of default or delinquency, notice of acceleration, notice of protest and nonpayment, notice of costs, expenses or losses and interest thereon, notice of interest on interest and late charges, and diligence in taking any action to collect any sums owing under this Note or in proceeding against any of the rights or interest in or to properties securing payment of this Note.

Time is of the essence with respect to every provision in this Note. This Note shall be construed and enforced in accordance with the substantive and procedural laws of the State of California, except to the extent that Federal laws preempt the laws of the State of California, and all persons and entities in any manner obligated under this Note consent to the jurisdiction of any Federal or State Court within the State of California having proper venue and also consent to service of process by any means authorized by California or Federal law.

This Note shall be cancelled upon Debtor's Transfer of the Property in accordance with the Declaration.

Debtor – [Name]

Attachment B
DEED OF TRUST

Free Recording Requested Pursuant to
Government Code Section 27383

When recorded, mail to:
San Francisco Redevelopment Agency
770 Golden Gate Avenue
San Francisco, California 94102
Attn: Harriet Starkes, Housing Division

----- Space Above This Line for Recorder's Use -----

SHORT FORM DEED OF TRUST AND ASSIGNMENT OF RENTS

THIS DEED OF TRUST, made on _____, 20____, between
_____, (“TRUSTOR” or “OWNER”),
whose address is _____, and
_____, a corporation, (“TRUSTEE”), and
the Redevelopment Agency of the City and County of San Francisco, a public body, corporate
and politic, whose address is 770 Golden Gate Avenue, San Francisco, California 94102,
 (“AGENCY” or “BENEFICIARY”),

WITNESSETH: That Trustor IRREVOCABLY GRANTS, TRANSFERS AND ASSIGNS to
TRUSTEE IN TRUST, WITH POWER OF SALE, that property in San Francisco County,
California, described as:

TOGETHER WITH the rents, issues and profits thereof, SUBJECT, HOWEVER, to the right,
power and authority given to and conferred upon Beneficiary by paragraph (10) of the provisions
incorporated herein by reference to collect and apply such rents, issues and profits.

For the Purpose of Securing: 1. Performance of each agreement of Trustor incorporated by
reference or contained herein. 2. Payment of the indebtedness evidenced by one promissory note
of even date herewith, and any extension or renewal thereof, executed by Trustor in favor of
Beneficiary or order. 3. Payment of such further sums as the then record owner of said property
hereafter may borrow from Beneficiary, when evidenced by another note (or notes) reciting it is
so secured.

INITIALS _____

To Protect the Security of this Deed of Trust, Trustor Agrees:

By the execution and delivery of this Deed of Trust and the note secured hereby, that provisions (1) to (14), inclusive, of the fictitious deed of trust recorded in Santa Barbara County and Sonoma County October 18, 1961, and in all other counties October 23, 1961, in the book and at the page of Official Records in the office of the county recorder of the county where said property is located, noted below opposite the name of such county, viz:

COUNTY	BOOK	PAGE
San Francisco	A332	905

which provisions, identical in all counties, (printed on the attached unrecorded pages) are hereby adopted and incorporated herein and made a part hereof as fully as though set forth herein at length; that Trustor will observe and perform said provisions; and that the references to property, obligations and parties in said provisions shall be construed to refer to the property, obligations, and parties set forth in this Deed of Trust.

The undersigned Trustor requests that a copy of any Notice of Default and of any Notice of Sale hereunder be mailed to him at his address hereinbefore set forth.

STATE OF CALIFORNIA
COUNTY OF _____
ON _____ before
me, _____

personally known to me (or proved to me on the basis of satisfactory evidence) to be the person(s) whose name(s) is/are subscribed to the within instrument and acknowledged to me that he/she/they executed the same in his/her/their authorized capacity(ies), and that by his/her/their signature(s) on the instrument the person(s), or the entity upon behalf of which the person(s) acted, executed the instrument.

Witness my hand and official seal.

Signature _____

DO NOT RECORD

The following is a copy of provisions (1) to (14), inclusive, of the fictitious deed of trust, recorded in each county in California, as stated in the foregoing Deed of Trust and incorporated by reference in said Deed of Trust as being a part thereof as if set forth at length therein.

TO PROTECT THE SECURITY OF THIS DEED OF TRUST, TRUSTOR AGREES:

(1) To keep said property in good condition and repair; not to remove or demolish any building thereon; to complete or restore promptly and in good and workmanlike manner any building which may be constructed, damaged or destroyed thereon and to pay when due all claims for labor performed and materials furnished therefor; to comply with all laws affecting said property on requiring any alterations or improvements to be made thereon; not to commit or permit waste thereof; not to commit, suffer or permit any act upon said property in violation of law; to cultivate, irrigate, fertilize, fumigate, prune and do all other acts which from the character or use of said property may be reasonably necessary, the specific enumerations herein not excluding the general.

(2) To provide, maintain and deliver to Beneficiary fire insurance satisfactory to and with loss payable to Beneficiary. The amount collected under any fire or other insurance policy may be applied by Beneficiary upon any indebtedness secured hereby and in such order as Beneficiary may determine, or at option of Beneficiary the entire amount so collected or any part thereof may be released to Trustor. Such application or release shall not cure or waive any default or notice of default hereunder or invalidate any act done pursuant to such notice.

(3) To appear in and defend any action or proceeding purporting to affect the security hereof or the rights or powers of Beneficiary or Trustee; and to pay all costs and expenses, including cost of evidence of title and attorney's fees in a reasonable sum, in any such action or proceeding in which Beneficiary or Trustee may appear, and in any suit brought by Beneficiary to foreclose this Deed.

(4) To pay: at least ten days before delinquency all taxes and assessments affecting said property, including assessments on appurtenant water stock; when due, all incumbrances, charges and liens, with interest, on said property or any part thereof, which appear to be prior or superior hereto; all costs, fees and expenses of this Trust. Should Trustor fail to make any payment or to do any act as herein provided, then Beneficiary or Trustee, but without obligation so to do and without notice to or demand upon Trustor and without releasing Trustor from any obligation hereof, may: make or do the same in such manner and to such extent as either may deem necessary to protect the security hereof, Beneficiary or Trustee being authorized to enter upon said property for such purposes; appear in and defend any action or proceeding purporting to affect the security hereof or the rights or powers of Beneficiary or Trustee; pay, purchase, contest or compromise any incumbrance, charge or lien which in the judgment of either appears to be prior or superior hereto; and, in exercising any such powers, pay necessary expenses, employ counsel and pay his reasonable fees.

(5) To pay immediately and without demand all sums so expended by Beneficiary or Trustee, with interest from date of expenditure at the amount allowed by law in effect at the date hereof, and to pay for any statement provided for by law in effect at the date hereof regarding the

INITIALS _____

obligation secured hereby any amount demanded by the Beneficiary not to exceed the maximum allowed by law at the time when said statement is demanded.

(6) That any award of damages in connection with any condemnation for public use of or injury to said property or any part thereof is hereby assigned and shall be paid to Beneficiary who may apply or release such moneys received by him in the same manner and with the same effect as above provided for disposition of proceeds of fire or other insurance.

(7) That by accepting payment of any sum secured hereby after its due date, Beneficiary does not waive his right either to require prompt payment when due of all other sums so secured or to declare default for failure so to pay.

(8) That at any time or from time to time, without liability therefor and without notice, upon written request of Beneficiary and presentation of this Deed and said note for endorsement, and without affecting the personal liability of any person for payment of the indebtedness secured hereby, Trustee may: reconvey any part of said property; consent to the making of any map or plat thereof; join in granting any easement thereon; or join in any extension agreement or any agreement subordinating the lien or charge hereof.

(9) That upon written request of Beneficiary stating that all sums secured hereby have been paid, and upon surrender of this Deed and said note to Trustee for cancellation and retention and upon payment of its fees, Trustee shall reconvey, without warranty, the property then held hereunder. The recitals in such reconveyance of any matters or facts shall be conclusive proof of the truthfulness thereof. The Grantee in such reconveyance may be described as "the person or persons legally entitled thereto." Five years after issuance of such full reconveyance, Trustee may destroy said note and this Deed (unless directed in such request to retain them).

(10) That as additional security, Trustor hereby gives to and confers upon Beneficiary the right, power and authority, during the continuance of these Trusts, to collect the rents, issues and profits of said property, reserving unto Trustor the right, prior to any default by Trustor in payment of any indebtedness secured hereby or in performance of any agreement hereunder, to collect and retain such rents, issues and profits as they become due and payable. Upon any such default, Beneficiary may at any time without notice, either in person, by agent, or by a receiver to be appointed by a court, and without regard to the adequacy of any security for the indebtedness hereby secured, enter upon and take possession of said property or any part thereof, in his own name sue for or otherwise collect such, rents, issues, and profits, including those past due and unpaid, and apply the same, less costs and expenses of operation and collection, including reasonable attorney's fees, upon any indebtedness secured hereby, and in such order as Beneficiary may determine. The entering upon and taking possession of said property, the collection of such rents, issues and profits and the application thereof as aforesaid, shall not cure or waive any default or notice of default hereunder or invalidate any act done pursuant to such notice.

(11) *That upon default* by Trustor in payment of any indebtedness secured hereby or in performance of *any agreement hereunder*, Beneficiary may declare all sums secured hereby immediately due and payable by delivery to Trustee of written declaration of default and demand for sale and of written notice of default and of election to cause to be sold said property, which notice Trustee shall cause to be filed for record. Beneficiary also shall deposit with Trustee this

INITIALS _____

Deed, said note and all documents evidencing expenditures secured hereby.

After the lapse of such time as may then be required by law following the recordation of said notice of default, and notice of sale having been given as then required by law, Trustee, without demand on Trustor, shall sell said property at the time and place fixed by it in said notice of sale, either as a whole or in separate parcels, and in such order as it may determine, at public auction to the highest bidder for cash of lawful money of the United States, payable at time of sale. Trustee may postpone sale of all or any portion of said property by public announcement at such time and place of sale, and from time to time thereafter may postpone such sale by public announcement at the time fixed by the proceeding postponement. Trustee shall deliver to such purchaser its deed conveying the property so sold, but without any covenant or warranty, express or implied. The recitals in such deed of any matters or facts shall be conclusive proof of the truthfulness thereof. Any person, including Trustor, Trustee, or Beneficiary as hereinafter defined, may purchase at such sale.

After deducting all costs, fees and expenses of Trustee and of this Trust, including cost of evidence of title in connection with sale, Trustee shall apply the proceeds of sale to payment of: all sums expended under the terms hereof, not then repaid, with accrued interest at the amount allowed by law in effect at the date hereof; all other sums then secured hereby; and the remainder, if any, to the person or persons legally entitled thereto.

(12) Beneficiary, or any successor in ownership of any indebtedness secured hereby, may from time to time, by instrument in writing, substitute a successor or successors to any Trustee named herein or acting hereunder, which instrument, executed by the Beneficiary and duly acknowledged and recorded in the office of the recorder of the county or counties where said property is situated, shall be conclusive proof of proper substitution of such successor Trustee or Trustees, who shall, without conveyance from the Trustee predecessor, succeed to all its title, estate, rights, powers and duties. Said instrument must contain the name of the original Trustor, Trustee and Beneficiary hereunder, the book and pages where this Deed is recorded and the name and address of the new Trustee.

(13) That this Deed applies to, inures to the benefit of, and binds all parties hereto, their heirs, legatees, devisees, administrators, executors, successors and assigns. The term Beneficiary shall mean the owner and holder, including pledgees, of the note secured hereby, whether or not named as Beneficiary herein. In this Deed, whenever the context so requires, the masculine gender includes the feminine and/or neuter, and the singular number includes the plural.

(14) That Trustee accepts this Trust when this Deed, duly executed and acknowledged, is made a public record as provided by law. Trustee is not obligated to notify any party hereto of pending sale under any other Deed of Trust or of any action or proceeding in which Trustor, Beneficiary or Trustee shall be a party unless brought by Trustee.

INITIALS _____

REQUEST FOR FULL RECONVEYANCE

TO: _____, TRUSTEE:

The undersigned is the legal owner and holder of all indebtedness secured by the within Deed of Trust. All sums secured by said Deed of Trust have been fully paid and satisfied; and you are hereby requested and directed, on payment to you of any sums owing to you under the terms of said Deed of Trust, to cancel all evidences of indebtedness, secured by said Deed of Trust, delivered to you herewith, together with the said Deed of Trust, and to reconvey, without warranty, to the parties designated by the terms of said Deed of Trust, all the estate now held by you under the same.

Dated: _____

By: _____ By: _____

Please mail Reconveyance to:

Do not lose or destroy this Deed of Trust OR THE NOTE which it secures. Both original documents must be delivered to the Trustee for cancellation before reconveyance will be made.

STATE OF CALIFORNIA
COUNTY OF SAN FRANCISCO

ON _____ before me, _____ personally appeared personally known to me (or proved to me on the basis of satisfactory evidence) to be the person(s) whose name(s) is/are subscribed to he within instrument end acknowledged to me that he/she/they executed the same in his/her/their authorized capacity(ies), and that by his/her/their signature(s) on the instrument the person(s), or the entity upon behalf of which the person(s) acted, executed the instrument.

WITNESS my hand and official seal.

Signature _____

Attachment C

ADDENDUM TO DEED OF TRUST

Free Recording Requested Pursuant to
Government Code Section 27383

When recorded, mail to:
San Francisco Redevelopment Agency
770 Golden Gate Avenue
San Francisco, California 94102
Attn: Harriet Starkes, Housing Division

----- Space Above This Line for Recorder's Use -----

ADDENDUM TO DEED OF TRUST

THIS ADDENDUM TO DEED OF TRUST ("Addendum") is part of the Deed of Trust and Assignment of Rents dated _____, 20__ ("Deed of Trust"), to which it is attached, made on _____, 20__, between _____ ("Trustor" or "Owner"), whose address is _____, and _____, a corporation ("Trustee"), and the Redevelopment Agency of the City and County of San Francisco, a public body, corporate and politic, whose address is 770 Golden Gate Avenue, San Francisco, California 94102 ("Agency" or "Beneficiary"). The following provisions are made a part of the Deed of Trust:

Owner obtained a loan ("Senior Lien") from _____ ("Senior Lender"), which Loan is secured by a first deed of trust lien on the Property ("First Deed of Trust").

Owner and Agency executed a Declaration of Resale Restrictions and Option to Purchase Agreement, dated the same date as the Deed of Trust ("Declaration"). The Declaration establishes, in part, the rights and obligations of Owner and the Agency in the event of a Transfer of the Property. "Transfer" means any voluntary or involuntary sale, assignment or transfer of any interest in the Property.

Owner and the Agency also executed a Promissory Note, dated the same date as the Deed of Trust and this Addendum to Deed of Trust, which is secured by the Deed of Trust ("Agency Note").

Capitalized terms used herein and not defined shall have the meanings set forth in the Declaration.

COVENANTS. Owner and the Agency covenant and agree as follows:

1. Prior Deeds of Trust; Charges; Liens. Owner shall perform all of Owner's obligations under the First Deed of Trust, including Owner's covenants to make payments when due. Owner shall pay on time and directly to the person owed payment all taxes, assessments, charges, fines and impositions attributable to the Property which may attain priority over this Deed of Trust.

Except for the Senior Lien, Owner shall promptly discharge any other lien which shall have attained priority over this Deed of Trust unless Owner: (a) contests in good faith the lien by, or defends against enforcement of the lien in, legal proceedings which, in the Agency's sole discretion, operate to prevent the enforcement of the lien; or (b) obtains from the holder of the lien an agreement satisfactory to the Agency in its sole discretion subordinating the lien to this Deed of Trust. Except for the Senior Lien, if the Agency determines that any part of the Property is subject to a lien which may attain priority over this Deed of Trust, the Agency may give Owner a notice identifying the lien. Owner shall satisfy such lien or take one or more of the actions set forth above within ten (10) days of the giving of notice.

2. Obligations Cancelled. Upon a Transfer of the Property in accordance with the Declaration, Owner's obligations hereunder shall be cancelled, and the lien of this Deed of Trust shall be reconveyed.

3. Sale of Note. The Agency Note or a partial interest in the Agency Note (together with this Deed of Trust) may be sold one or more times without prior notice to Owner. If the Agency Note is sold, Owner will be given written notice of the sale in accordance with and containing any other information required by applicable law.

BY SIGNING BELOW, the Owner accepts and agrees to the terms and covenants contained in this Deed of Trust.

Owner – [Name]

----- Space Below This Line for Acknowledgment -----

Attachment D
FORM OF INCOME CERTIFICATION

Attachment E
PERMITTED EXCEPTIONS TO TITLE

Attachment F

LOAN DISCLOSURE INFORMATION

**SAN FRANCISCO
REDEVELOPMENT AGENCY**

**LIMITED EQUITY
HOMEOWNERSHIP PROGRAM**

Loan Disclosure Information

JULY 2003

TABLE OF CONTENTS

Important Note to the Reader.....	Page 3
Buyer Acknowledgement.....	Page 5
Program Summary	Page 6
Program Elements.....	Page 7
Eligibility.....	Page 7
Affordable Purchase Prices.....	Page 7
Resale Affordable Purchase Prices.....	Page 9
Capital Improvements.....	Page 10
Minimum Resale Value.....	Page 11
Owner Refinancing.....	Page 12
Permissible Transfers & Agency Broker Panel.....	Page 13
Agency Purchase Option.....	Page 14
Owner Default & Agency Remedies.....	Page 14
Agency Promissory Note and Deed of Trust.....	Page 15
Transfer by Marriage, Domestic Partnership, and Inheritance.....	Page 16
Term.....	Page 16

I M P O R T A N T

NOTE TO THE READER

The purpose of this document is to explain the San Francisco Redevelopment Agency's Limited Equity Homeownership Program ("Program"). Homes sold through this Program are subject to price controls at resale, as well as other terms and restrictions that affect your rights as a homeowner. Some of the terms and provisions are complex, and require that you thoroughly understand them prior to your purchase of a home. **IF YOU DESIRE TO PARTICIPATE IN THE PROGRAM AND PURCHASE A HOME, YOU MUST ATTEST TO YOUR FULL UNDERSTANDING OF AND AGREEMENT TO ALL THE PROGRAM'S TERMS AND CONDITIONS BY SIGNING BELOW PRIOR TO CLOSING ESCROW.**

I, the undersigned, hereby acknowledge and accept all the terms and conditions contained in the Declaration of Resale Restrictions and Option to Purchase, the Promissory Note Secured by a Deed of Trust, and the Short Form Deed of Trust and Assignment of Rents (“Agency Documents”), all of which I have agreed to comply with in return for purchasing my home at a below-market-rate price. I acknowledge that a staff member of the Redevelopment Agency of the City and County of San Francisco (“Agency”) explained the terms and provisions of the Agency Documents to me, and that I have had a chance to review this Limited Equity Homeownership Program Loan Disclosure Information document, which further explains the Agency Documents. I have also been provided enough time to seek an independent legal opinion about the Agency Documents and my purchase of the home, if I so chose.

I understand that by my execution of the Agency Documents, I agree that the resale price of my home will be restricted to a price that is affordable to a household of a predetermined size, earning a pre-determined percentage of Area Median Income (“AMI”), based on figures published by the Mayor’s Office of Housing, based on data published by the U.S. Department of Housing and Urban Development (or any government agency subsequently assuming this responsibility). I understand that the Agency will determine the resale affordable price applicable to my home when I notify the Agency of my intent to sell. I understand that fair market value will not determine the resale price of my home.

I further understand that the Agency's calculation of the resale affordable purchase price for my home will consider, in addition to the current income for a pre-determined AMI level, current mortgage interest rates and other current housing costs, such as insurance, HOA dues, and taxes. I know that any proceeds I receive from the sale of my home will be affected by the value of these factors, since they will be used to calculate the resale affordable purchase price of my home.

I understand that the Agency imposes resale restrictions on homes that it subsidizes so that it can provide homeownership opportunities to many generations of low- and moderate-income families over time and that the equity I will be able to build in my home will be limited so that the Program is available to the next purchaser of my home. I understand that my ability to purchase my home at an affordable price is contingent upon my agreement to comply with the resale controls and Program restrictions.

PROPERTY ADDRESS: _____

SIGNED: _____ DATE: _____

_____ DATE: _____

PROGRAM SUMMARY

- The purpose of the San Francisco Redevelopment Agency's Limited Equity Homeownership Program ("Program") is to provide homeownership opportunities to low- and moderate-income households ("Eligible Buyers") who otherwise would not be able to purchase a home in San Francisco.
- To make homes affordable to Eligible Buyers, the Agency may sell land to developers at below-market-rate prices and/or provide construction funding. In return for this assistance, developers agree to sell the homes to Eligible Buyers. Eligible Buyers, in turn, purchase their homes at affordable prices and agree to comply with Program requirements.
- The Agency is able to offer the benefits of homeownership to many generations of Eligible Buyers through restrictions on resale prices, which limit the amount of equity that an Eligible Buyer is able to build. By limiting Eligible Buyers' equity, homes can be sold at affordable prices again and again. Market fluctuations, which often result in prices too high for low- and moderate-income households to afford, do not affect limited equity resale affordable prices.

PROGRAM ELEMENTS

#1: Eligibility

To qualify as an Eligible Buyer, households must meet the following criteria:

- Household income (including income imputed from assets) within the AMI “target range” of low- to moderate-income buyers.
- Demonstrable ability to qualify for a first mortgage, i.e., good credit, stable employment, and manageable debt.
- Savings available for a 5% down payment.
- First-time homeowner status.
- Commitment to use the property as the principal residence.

The San Francisco Mayor’s Office of Housing publishes AMI levels for San Francisco annually, based on data published by the U.S. Department of Housing and Urban Development. The AMI target ranges that determine a household’s eligibility to purchase will vary from development to development, based on the amount of subsidy provided by the Agency to the developer. The Agency will qualify all buyers for both initial sales and for resales. Documentation of household income and assets, such as W-2s, tax returns, bank statements, and deferred income balance statements, is required.

#2: Affordable Purchase Prices

When developers set affordable purchase prices for units they sell, they use very specific information, as described below:

- AMI level: Developers in contract with the Agency are obligated to sell their units at prices affordable to households within a certain AMI “target range.” For example, a developer in 2003 may be obligated to sell his/her units to households making between

75% and 100% of AMI. For a household of 3, this translates to incomes between \$61,765 and \$82,350.

- Household size: The Agency assumes household size of one person more than the number of bedrooms. For example, a household of two people is assumed for a one-bedroom, three people for a two-bedroom, four people for a three-bedroom, and so on.
- 33% "PITI": Principal, interest, taxes, and homeowners' insurance – total housing costs – cannot exceed 33% of a household's gross monthly income.
- First mortgage interest rate: the Agency's calculation assumes a fixed mortgage interest rate based on market conditions at the time the homes are offered for sale.
- Owner down payment: The Agency assumes that the household will make a cash down payment of 5% of the affordable purchase price.

Once a developer knows, for each unit, what the applicable AMI level is, the household size, the cost of taxes and insurance, and the interest rate, he/she can set the affordable purchase price. For example, a two-bedroom unit assumes a household of three. If the developer's obligation calls for an AMI level of 80%, the three-person household's income would be \$65,900. 33% of that income level is \$21,747, or \$1,812 per month. This figure, \$1,812 is the most the household will pay for PITI at the time of purchase. (This might fluctuate over time.) If the household's insurance costs were \$100 per month, and taxes were \$210 per month, the total monthly income available to pay the first mortgage would be \$1,502 per month. Using an 8% interest rate, the first mortgage value would be \$204,698. Assuming a 5% down payment, the first mortgage would cover 95% of the purchase price, so the affordable purchase price would be \$215,471.

#3: Resale Affordable Purchase Prices

When a household decides to sell its home, it notifies the Agency, and the Agency calculates the resale affordable purchase price, using the same AMI percentage and household size that were used to calculate the seller's affordable purchase price. To follow the example given above, the family of 3 earning 80% of AMI that bought its home for \$215,471 in 2003 might decide to sell the home five years later. The Agency will determine the resale price by taking the income for a 3-person household at 80% of AMI in 2008. It will limit PITI to 33% of gross monthly income, using a current mortgage interest rate and current tax and insurance costs, and it will assume a 5% down payment by the new eligible buyer. So, for example, if AMI increased 10% between 2003 and 2008, taxes and insurance increased by 5%, and interest rates held steady, the resale affordable purchase price would be \$239,429. After subtracting the cost of necessary repairs (if any) and closing costs, the seller would be entitled to the difference between the old affordable price and the new affordable price. The example is shown numerically below:

80% AMI, 3-person HH income, 2008 (2003 + 10%):	\$72,490
33% of gross income:	\$23,922
Per month:	\$1,994
Monthly taxes & insurance, 2008 (2003 + 5%)	(\$325)
Monthly income available for 1 st mortgage:	\$1,669
Mortgage (assuming 8% interest, 30-yr fixed)	\$227,457
5% Down payment:	\$11,972
Resale Affordable Purchase Price:	\$239,429
Transactional costs (6%)	(\$14,366)
Repayment of full value of 1 st mort + down payment:	(\$215,471)
Owner's proceeds:	\$9,592*

*In this case, no repairs were required, but closing costs, which came in at 6% of the selling price, were deducted from the resale affordable purchase price. After deducting the full value of the owner's original affordable price, the seller proceeds equal \$9,592. Note that this limited

equity return *is in addition to* all principal paid down on the first mortgage and the return of the owner's original 5% down payment.

By transferring this property from one 80% AMI household to another under the Program, the home remains affordable, the benefits of homeownership are passed along, and all owners have a chance to earn limited equity!

#4: Capital Improvements

As shown above, AMI levels and current housing costs such as interest rates and insurance costs determine affordable prices. Affordable purchase prices alone can't, therefore, reflect improvements and upgrades that an owner has made to his/her unit, such as new floors and countertops. To avoid discouraging owners from improving their properties, the Agency will allow owners to recover for the amortized value of approved capital improvements.

To qualify, each capital improvement must meet certain criteria:

- It must be a permanent improvement.
- It must have a value greater than .5% but less than 10% of the affordable purchase price originally paid by the owner.
- It must have a useful life longer than 5 years after the owner sells the home.
- It must have been installed with all required permits and approvals.

Owners wishing to sell and recover a portion of the cost of capital improvements must give the Agency a list of capital improvements and the date installed or completed, with invoices or other verifying documentation, at least thirty (30) days before the property is sold or transferred. The Agency must approve the capital improvements (i.e., make sure they meet the criteria described above), and will allow owners to recover the approved, amortized amount at escrow closing.

The credit for each capital improvement is amortized by a factor of 7% per year from the date of the capital improvement's completion.

#5: Minimum Resale Value

As described above, the resale affordable purchase price is subject to variable factors that fluctuate over time, such as mortgage interest rates, taxes, and insurance costs. Because of the variability of these factors, *owners assume some risk when they purchase their homes!* For example, if interest rates are low when an owner buys, but high when that owner sells, and increases in AMI over time do not compensate for the interest rate spike, a resale affordable purchase price could actually be lower than the original price an owner paid. To minimize the risk owners take when they participate in the Program, the Agency will increase the applicable AMI level on a resale, up to 120% of AMI, when the original AMI level applicable to that home does not result in a resale affordable price high enough to pay off the original value of the first mortgage.

If, after making this adjustment to ensure first mortgage payoff, the resultant resale affordable price is still not high enough to return an owner's original down payment funds and to cover standard closing expenses, the Agency will deposit funds into escrow to cover these expenses, as a credit to the owner.

The Agency's goal is to ensure that owners in the Program will recover at least the original purchase price of their home, so that their sale proceeds equal, at a minimum, the value of their down payment and any principal paid down on the first mortgage. The Agency also seeks to prevent closing costs from wiping out this minimum return, and will therefore cover closing costs as necessary.

But owners still assume risk! Owners are solely responsible for:

- Repair costs. When an owner notifies the Agency of its intent to sell, the Agency has the right to inspect the unit, determine if damage exists, and calculate the value of repair. If the owner does not satisfactorily make the itemized repairs, owners will be held responsible for repair costs at the close of escrow.
- Payments due on junior liens and first mortgage equity refinancing. The Agency will only increase a resale affordable purchase price to the original value of the first mortgage. If the owner has refinanced the home and withdrawn equity, the owner is solely responsible for paying off the incremental value of the refinanced mortgage or new, junior liens.
- If the resale affordable purchase price produced using 120% of AMI is still insufficient to pay off the first mortgage, the owner is solely responsible for his/her mortgage debt beyond that adjusted resale affordable purchase price.

#6: Owner Refinancing

To protect its investment and to preserve the intent of the Program, the Agency must approve all refinancing agreements.

Owners can refinance up to the original value of their first mortgage in order to obtain a lower interest rate or withdraw principal paid down on the mortgage.

Owners may also refinance their homes to withdraw up to 50% of the difference between the resale affordable purchase price and their original affordable purchase price, for the following reasons only:

- To make capital improvements to the home
- To pay for post-secondary educational expenses of a household member
- To meet the cost of an owner's or owner's immediate family member's catastrophic illness
- To secure funds required to implement a marriage dissolution agreement or domestic partnership dissolution agreement.

#7: Permissible Transfers & Agency Broker Panel

Owners may only transfer their homes to other Eligible Buyers or the Agency. In order to help owners find new Eligible Buyers when they are ready to sell, the Agency has established a broker panel. These licensed real estate brokers are familiar with the Agency's Program and requirements, and direct a portion of their marketing to low- and moderate-income clients.

Owners are not required to use the Agency's broker panel, but they are required to sell to new Eligible Buyers that only the Agency can qualify as "eligible".

If, after 150 days from the date an owner lists its property for sale and a demonstrated good faith effort on the part of the owner and his/her broker to sell the home, an owner cannot locate a new Eligible Buyer, the Agency will authorize a 50% increase to the AMI level defining "Eligible Buyer" for that particular home. ("Good faith effort" means use of all standard marketing tools, such as a Multiple Listing Service listing, advertised open houses, and other, additional advertising.) For example, if an owner's good faith effort to find an Eligible Buyer at 80% of AMI failed after 150 days, he/she could renew the search and include as potential buyers households earning up to 120% of AMI. The resale affordable purchase price would remain the same (i.e., based on the 80% AMI income), thus enhancing the home's marketability to the higher-income households.

#8: Agency Purchase Option

While the Agency may purchase the home as an Eligible Buyer (in a standard sale transaction), it retains an option to purchase the home in the event of owner default, under either the Agency Documents or the first mortgage.

#9: Owner Default and Agency Remedies

An owner is in default of the Agency Documents if any of the following occur:

- A transfer of the property in violation of the Declaration of Resale Restrictions and Option to Purchase;
- Use of the property other than as owner's principal residence (owners must certify that they occupy the home at least 10 months out of every 12 annually);
- Failure to pay required housing costs, such as taxes, homeowner dues, assessments, or insurance;
- Placement of any mortgages, liens or encumbrances on the property that the Agency has not approved;
- Any other violation of the Agency Documents; or
- A default on the first mortgage.

If an owner is in default and doesn't or can't cure the default within the times specified in the Agency Documents or first mortgage documents, the Agency can exercise its purchase option, commence an action for specific performance or an injunction to prevent an impermissible sale, foreclose on its deed of trust, and/or exercise any other remedy permitted by law.

#10: Agency Promissory Note and Deed of Trust

To protect its investment, the Agency requires that all owners execute a promissory note and deed of trust when they purchase their homes. Unlike standard promissory notes for conventional mortgages, the Agency promissory note has no face value and cannot be prepaid. Its purpose is to protect the Agency's investment if an owner defaults on the first mortgage or Agency obligations. An owner default "triggers" the promissory note and Agency deed of trust, which secures the promissory note against the property and is recorded to provide public notice of the owner's obligations under the Program. In the case of default, the promissory note states that the owner must pay the Agency the difference between the resale affordable purchase price and fair market value, in addition to any costs incurred by the Agency to enforce its rights and a default interest payment on the sum due. An independent appraiser will determine fair market value.

Financing for the 3-person, 80% AMI household can again illustrate the issue. This household had a resale affordable purchase price of \$239,429. If they defaulted on their loan, and fair market value was, for example, \$550,000, they would owe the Agency \$310,571 (plus default-related costs) under the Agency's promissory note.

If an owner transfers his/her property according to the Program requirements and complies with all other Agency and first mortgage obligations, the Agency will simply terminate the promissory note and deed of trust at resale.

#11: Transfer by Marriage, Domestic Partnership, and Inheritance

If an owner marries or enters a domestic partnership, the spouse or partner can become a co-owner by executing an addendum to the Agency Documents. The addendum confers the same rights and obligations of the owner upon the spouse or partner.

Upon the death of a property owner or owners, the home can be transferred to an heir, as long as the heir is an Eligible Buyer approved by the Agency. If the heir does not qualify to occupy the home, the home must be sold according to the terms of the Agency Documents, and the owner's proceeds will transfer to the owner's estate.

#12: Term

The term of the Agency Documents – or the period of time that resale restrictions and all other Agency obligations apply – is 45 years. At the end of the term, owners are obligated to pay to the Agency the difference between the resale affordable purchase price and fair market value. In lieu of this payment, an owner may opt to renew his/her agreements with the Agency for an additional 45-year term.

EXHIBIT E

MEMORANDUM OF OPTION

FOR 15% OF VERTICAL DEVELOPER RESIDENTIAL UNITS

EXHIBIT E

MEMORANDUM OF OPTION

FOR 15% OF VERTICAL DEVELOPER RESIDENTIAL UNITS

RECORDING REQUESTED BY AND
WHEN RECORDED MAIL TO:

Redevelopment Agency of City and
County of San Francisco
770 Golden Gate Avenue
San Francisco, California 94102

Attn: Executive Director

This document is exempt from payment
of a recording fee pursuant to Government Code
Section 27383.

MEMORANDUM OF OPTION

THIS MEMORANDUM OF OPTION is entered into as of _____, 200__ by and between Lennar/BVHP, LLC ("Developer") and the Redevelopment Agency of the City and County of San Francisco, a public body, corporate and politic, of the State of California ("Agency"). Developer grants to Agency the right to purchase up to fifteen percent (15%) of the Vertical Developer Residential Units to be constructed in the development of the former Hunters Point Naval Shipyard, Phase 1, in the City and County of San Francisco, on the terms and conditions set forth in the Disposition and Development Agreement for Hunters Point, Phase 1, and Attachment 22 thereto, recorded in the official records of the City and County of San Francisco on _____, 200__ as Document Number _____.

IN WITNESS WHEREOF, Agency and Developer have executed this Memorandum of Option as of the date written above.

AGENCY:

Redevelopment Agency of the City and
County of San Francisco

DEVELOPER:

Lennar/BVHP, LLC

BY: _____
Executive Director

BY: _____

ALL SIGNATURES MUST BE NOTARIZED.

----- Space Below This Line for Acknowledgment -----

EXHIBIT F

RELEASE OF OPTION RIGHTS

RECORDING REQUESTED BY AND
WHEN RECORDED MAIL TO:

Redevelopment Agency of City and
County of San Francisco
770 Golden Gate Avenue
San Francisco, California 94102

Attn: Executive Director

This document is exempt from payment
of a recording fee pursuant to Government Code
Section 27383.

RELEASE OF OPTION RIGHTS

THIS RELEASE OF OPTION RIGHTS (the "Release") is executed as of _____, 200__ (the "Effective Date") by the Redevelopment Agency of the City and County of San Francisco, a public body, corporate and politic, of the State of California (the "Agency"). The Agency was granted the right to purchase up to fifteen percent (15%) of the Vertical Developer Residential Units to be constructed in the development of the former Hunters Point Naval Shipyard, Phase 1, in the City and County of San Francisco, on the terms and conditions set forth in the Disposition and Development Agreement for Hunters Point, Phase 1, and Attachment 26 thereto, recorded in the Official Records of the City and County of San Francisco on _____, 200__ as Document Number _____ (the "Option Rights"). A Memorandum of Option referencing the Agency's Option Rights was recorded in the Official Records of the City and County of San Francisco on _____, 200__ as Document Number _____. Among other properties, the Option Rights apply to that certain real property in the City and County of San Francisco more particularly described in the attached Exhibit A (the "Released Property" – which will describe only the units as to which the Agency has elected not to exercise its Option Rights) pursuant to the [describe Vertical DDA] recorded in the Official Records of the City and County of San Francisco on _____, 200__ as Document Number _____. By this Release, as of the Effective Date, the Agency hereby releases its Option Rights as they apply to the Released Property. The Agency retains its Option Rights as to all other property.

The Agency will take further actions, including without limitation executing additional documents in recordable form, if reasonably necessary or proper in order to effect the release of its Option Rights consistent with this Release.

The Agency has executed this Release as of the Effective Date.

Authorized by Agency Resolution
No. _____, adopted _____, _____

AGENCY:
Redevelopment Agency of the City and
County of San Francisco

APPROVED AS TO FORM:

By: _____
[Executive Director]

By _____
James Morales,
Agency General Counsel

By: _____
[Secretary]

ALL SIGNATURES MUST BE NOTARIZED.

----- Space Below This Line for Acknowledgment -----

EXHIBIT A
RELEASED PROPERTY

**[Describe only those units as to which the Agency has elected not to exercise its
Option Rights.]**

EXHIBIT G

MAJOR PHASE HOUSING DATA TABLE

EXHIBIT G

MAJOR PHASE HOUSING DATA TABLE

Submissions for Major Phase Approvals

In order to verify and to track compliance with the Affordable Housing Program, each Vertical Developer shall submit a Major Phase Housing Data Table as part of the application package for each Major Phase including Residential Units. Such Major Phase Housing Data Table shall be in a form mutually agreed upon by the Vertical Developer and the Agency and will contain the information described in subsections (a) and (b) below. Agency shall review and approve the Major Phase Housing Data Table in accordance with the procedures set forth in the Design Review and Document Approval Procedure, and development of such Major Phase shall proceed in accordance with such approvals. Agency will cooperate with Vertical Developers in providing the information required to complete the following Tables to the extent known by Agency and not known or reasonably discoverable by the Vertical Developer.

(a) Major Phase Data. The Major Phase Housing Data Table shall identify for the entire Major Phase:

- (1) The total acreage of Vertical Developer Residential Projects;
- (2) The total number of Residential Units proposed;
- (3) The total number of Market Rate Residential Units proposed;
- (4) The total number of Inclusionary Units proposed;
- (5) The allocation of Inclusionary Units among For-Rent and For-Sale Affordable Residential Units for the Major Phase; and
- (6) The location of For-Rent and For-Sale Inclusionary Units within the Major Phase, including a description of such Inclusionary Units in terms of size, number of bedrooms and amenities.

(b) Major Phase Parcel Data. For each parcel identified within a Major Phase, the Major Phase Housing Data Table shall identify the proposed:

- (7) Use (e.g., residential, retail, commercial, office, research and development);
- (8) Parcel acreage;
- (9) Maximum building height;
- (10) Total number of Residential Units; and
- (11) Number of Inclusionary Units, if any.

(b) Major Phase Housing Data Tables for subsequent Major Phases submitted after the first Major Phase Housing Data Table shall include aggregate development data in relation to the total allowable building program, including the data described above for prior Major Phases adjusted for Residential Projects which have received Schematic Design approval.

EXHIBIT H

PROJECT HOUSING DATA TABLE

EXHIBIT H

PROJECT HOUSING DATA TABLE

Submissions for Project Approvals

In order to verify and to track compliance with the Affordable Housing Program, each Vertical Developer shall submit a Project Housing Data Table as part of the application package at the time each Residential Project is submitted for its Project Basic Concept Design approval, as described in the Design Review and Document Approval Procedure for Vertical Development. Such Project Housing Data Table shall be in a form mutually agreed upon by the Vertical Developer and the Agency, and will contain the information described in subsections (a) and (b) below. The Agency shall review and approve the Project Housing Data Table in accordance with the procedures set forth in the Design Review Document Approval Procedure and development of such Project shall proceed in accordance with such approvals.

(a) Major Phase Data. The Project Housing Data Table shall identify the following information with respect to the entire Major Phase in which such Residential Project is located:

- (1) The total number of allowed Residential Units for the Major Phase;
- (2) The total number of acres and the number of Market Rate Residential Units including, for Residential Projects which have received Schematic Design approval, the number of For-Sale and For-Rent Residential Units, and the number of Inclusionary Units projected for the Major Phase, adjusted for Residential Projects which have received Schematic Design approval;
- (3) The total number of Vertical Developer Residential Units which have received Schematic Design approval, including the allocation of Inclusionary Units between For-Rent and For-Sale Residential Units for each Residential Project;
- (4) The total number of Vertical Developer Residential Units for which Building Permits have been issued;
- (5) The total number of Vertical Developer Residential Units which have received Certificates of Occupancy;
- (6) The total number of Vertical Developer Residential Units for which applications for Schematic Design approval are pending;
- (7) The total number of the remaining Vertical Developer Residential Units allowed for the Major Phase;
- (8) The total number of Inclusionary Units that have been approved in a Residential Project;

(9) The total number of Inclusionary Units approved in the Major Phase;

(10) The remaining total number of Inclusionary Units to be constructed in the Major Phase; and

(11) The allocation of Inclusionary Units between For-Rent and For-Sale Residential Units;

(12) The total number of Inclusionary Units, and the allocation of For-Sale and For-Rent Inclusionary Units, that have received Certificates of Occupancy.

(b) Project and Parcel Data. For each parcel within the Major Phase, including the subject Residential Project, the Project Housing Data Table shall identify:

(1) The current Owner;

(2) The current development status, including:

(A) Whether a Residential Project within the Major Phase has received Basic Concept Design and Schematic Design approval, and

(B) Whether a Building Permit, Certificate of Occupancy, and/or Certificate of Completion has or have been issued for a Residential Project and the dates thereof;

(3) The use and, if such Vertical Developer Residential Project has received Schematic Design approval, whether it is a For-Sale or For-Rent Residential Project;

(4) The parcel acreage;

(5) The maximum (or, if a Residential Project has already been constructed in that Major Phase, its actual) building height;

(6) The number of Total Vertical Developer Residential Units (for Projects which have received a Schematic Design approval) or the Major Phase approved number of Residential Units if the Project has not received Schematic Design approval;

(7) The number of For-Sale and For-Rent Inclusionary Units for Residential Projects which have received Schematic Design approval, or the number of For-Sale and For-Rent Inclusionary Units for Residential Projects which have not received Schematic Design approval.

EXHIBIT I
MARKETING AND OPERATIONS GUIDELINES

ATTACHMENT 22

EXHIBIT I

MARKETING AND OPERATING OBLIGATIONS

Section 1. Purpose.

A. This Exhibit I is attached to the Affordable Housing Program (the "Housing Program"), which in turn is attached as Attachment 22 to the Disposition and Development Agreement between the Redevelopment Agency of the City and County of San Francisco (the "Agency") and Lennar/BVHP, LLC ("Developer") dated _____, 2003 (the "DDA"). As provided in the DDA, this Exhibit I will in turn become part of the Vertical DDA and will be imposed on Vertical Developers, as those terms are defined in the DDA. The purpose of this Exhibit I is to set forth the Vertical Developer's marketing and operating obligations with respect to all Residential Units in Phase 1, including For-Rent Affordable Housing Units, For-Sale Affordable Housing Units, For-Rent Market Rate Residential Units and For-Sale Market Rate Residential Units.

B. This Exhibit I first sets forth the nondiscrimination requirements applicable to all Affordable and Market Rate Residential Units in Phase 1. It then sets forth the specific marketing, operating and reporting requirements applicable to each Affordable and Market Rate Residential Unit. In addition to this Exhibit I, the Vertical Developer will record against each For-Rent Affordable Housing Unit a Declaration of Restrictions in the form attached as Exhibit C to the Housing Program, and will record against each For-Sale Affordable Housing Unit a Declaration of Restrictions and Option to Purchase Agreement in the form attached as Exhibit D to the Housing Program. Each Declaration of Restrictions sets forth the income requirements and rental or sales price restrictions applicable to the Affordable Housing Units in a particular Residential Project.

C. In the event of any inconsistency between the terms of this Exhibit I and the DDA, including the Housing Program, the DDA and Housing Program shall control. In the event of any inconsistency between this Exhibit I and the Vertical DDA, including the Housing Program, the Vertical DDA and Housing Program shall control.

Section 2. Definitions.

Unless separately defined in this Exhibit I, capitalized terms have the meanings set forth in the DDA, the Vertical DDA and the Housing Program.

Affordable means, (a) with respect to a For-Rent Residential Unit, a monthly rental charge, including a utility allowance in an amount determined by the San Francisco Housing Authority, which does not exceed thirty percent (30%) of fifty percent (50%) of Area Median Income, based upon Imputed Household Size; and (b) with respect to a For-Sale Residential Unit, a purchase price based on a five percent (5%) down payment and a rate for a thirty (30)

year fixed mortgage based on a ten (10) year rolling average of rates published in the Wall Street Journal, with a total of annual payments for principal, interest, taxes, assessments and homeowner's association dues which does not exceed thirty-three percent (33%) of the Program Income Level.

Agency's Certificate Program means the Property Owner and Occupant Preference Program established in accordance with Section 33410, et seq., of the California Health & Safety Code.

Certificate Holder means an owner or occupant of residential property who meets the following criteria:

(a) The owner or occupant was displaced by either (i) the Agency's acquisition of such residential property, or (ii) the rehabilitation of such residential property where the owner of the property has entered into an owner participation agreement or other similar agreement with the Agency to perform such rehabilitation; and

(b) The Agency has determined that such individual is eligible to receive a Certificate of Preference pursuant to the relocation and replacement housing responsibilities of the Agency pursuant to Article 9, beginning with Section 33410, et seq., of the California Health and Safety Code ; and

(c) The Agency has certified such individual as a holder of a Certificate of Preference pursuant to the Agency's Certificate Program, as such program currently exists or as may be amended within ninety (90) days of the Vertical DDA], and such future amendments.

Certificate of Preference means a certificate issued by the Agency pursuant to the Agency's Certificate Program, to evidence the status of an owner or occupant of residential property as a Certificate Holder. For purposes of this Exhibit I, a Certificate of Preference may be either a "Residential A Certificate" issued to a displaced resident, or a "Residential C Certificate" issued to other members of a Residential A Certificate household.

For-Rent or Rental means a Residential Unit that is intended at the time of Complete Construction to be occupied subject to a lease, and not offered for sale.

For-Sale or Sale means a Residential Unit that is intended at the time of Complete Construction to be offered for sale, e.g., as a condominium for individual Residential Unit ownership.

Income Verification Information means the information required by the United States Department of Housing and Urban Development ("HUD") to determine eligibility for the rental of a For-Rent Affordable Housing Unit, or the purchaser of a For-Sale Affordable Housing Unit.

Lottery means the process the Vertical Developer uses to randomly select from all applications submitted, and develop a Potential Tenant or Potential Purchaser List.

Lottery List is defined in Section 5.1(c)(6).

Marketing Information means the following with respect to each Residential Project:

- (a) A master Residential Unit list which indicates the following:
 - (i) The unit numbers of Residential Units to be offered for Rental or Sale;
 - (ii) The number of bedrooms and baths in each such Residential Unit;
 - (iii) The approximate net square footage of each such Residential Unit;
 - (iv) A list of amenities in each such Residential Unit (*e.g.*, disposal, washer/dryer, etc.); and
 - (v) The initial rent or estimated purchase price, as appropriate, for each such Residential Unit.

- (b) For each For-Rent Affordable Housing Unit, the following additional items will be provided:
 - (i) The estimated itemized cost of utilities to be paid by each tenant household by Residential Unit size;
 - (ii) The amount of any deposit required to reserve a Residential Unit, security deposit and all other fees related to the rental of such unit; and a policy for the deposit, use and return of any such amounts;
 - (iii) The proposed duration of rental agreement or lease; and
 - (iv) copies of rental application and all forms to be used for Income Verification Information.

- (c) For each For-Rent or For-Sale Affordable Housing Unit, the following additional items will be provided:
 - (i) A detailed description of Vertical Developer's rules for tenants (or Covenants Conditions and Restrictions, as appropriate);
 - (ii) The amount of application processing fee, if any; and
 - (iii) A description of application process, and the length of time needed by Vertical Developer to process applications.

- (d) For each For-Sale Affordable Housing Unit the following additional item shall be provided:
 - (i) estimated cost of homeowner's association dues to be paid by Residential Unit size; and
 - (ii) estimated amount of Mello-Roos assessments affecting the unit at the time of initial sale.

Market Rate or Market Rate Residential Unit means a Residential Unit that has no restrictions under the Housing Program or the DDA with respect to affordability levels or income restrictions for occupants.

Occupancy Priorities means the priorities established in this document for occupancy of For-Sale and For-Rent Residential Units.

Potential Purchaser List means those applicants selected in the Lottery by the Vertical Developer to establish the application processing order for For-Sale Residential Units.

Potential Tenant List means those applicants selected in the Lottery by the Vertical Developer to establish the application processing order for For-Rent Residential Units.

Rent Burdened or Assisted Housing Resident means persons who are paying more than 50% of their income for housing or persons residing in public housing or Project-Based Section 8 Housing.

Rent-Up means the period of time from the date when the Residential Units in a Residential Project are first offered for lease until rental agreements have been signed for all such Residential Units in the Residential Project.

Residential Project means a development containing Residential Units.

Residential Unit means a dwelling unit consisting of a room or suite of two (2) or more rooms that is designed for residential occupancy.

San Francisco Residents means a household in which there are one or more persons eighteen (18) years or older residing in San Francisco at the time of the submittal of the housing application or purchase offer.

Second Lien Documents means the Agency Note and the Agency Deed of Trust as those documents are defined in Exhibit D to the Housing Program to be executed by the purchaser of each For-Sale Affordable Housing Unit.

Section 3. Nondiscrimination Requirements.

Vertical Developer acknowledges the goal of achieving a residential population in all Residential Projects developed in Phase 1 that reflects the racial and ethnic diversity of San Francisco. To that end, the Vertical Developer will comply with the affirmative marketing obligations described in this Exhibit I. In addition, in the marketing, operation and rental or sale of the Residential Units in Phase 1 (including the initial and subsequent rentals and sales of all Affordable Housing Units and all Market Rate Residential Units), the Vertical Developer and any subsequent owner of any such Residential Units shall not discriminate based on race, religion, color, ancestry, national origin, age, sex, sexual orientation, marital status, gender identity, disability, lawful source of income (as defined in Section 3304 of the San Francisco Police Code, including, but not limited to Section 8 or any equivalent rent subsidy), or any other basis prohibited by law. Nothing in this Section shall prohibit the Vertical Developer from applying

other lawful standards for resident selection or from exercising its rights in managing property, so long as such standards and rights are equitably applied to prospective and actual residents of both Affordable Housing Units and Market Rate Residential Units.

Section 4. Community Outreach for All Residential Units.

This Section 4 requires all Vertical Developers to comply with the community-based outreach requirements ("Community Outreach") described below in this section. The Community Outreach requirements must be implemented prior to the Affirmative Marketing Obligations outlined in Sections 5, 6, 7, and 8 (the "Affirmative Marketing Obligations") for all For-Rent and For-Sale Affordable Housing Units and For-Rent and For-Sale Market Rate Residential Units.

4.1 Notice.

At least thirty (30) days for For-Rent, and ninety (90) days for For-Sale, prior to initiation of the Affirmative Marketing Obligations or other public advertising and marketing of the Residential Units, the Vertical Developer shall provide community-based groups, faith-based organizations, and others in the Bayview Hunters Point area (based on a list developed with and approved by the Agency) with advance notice (the "Advance Notice") that affordable and/or market rate housing opportunities at the Shipyard will become available (the "Advance Notice Period"). This Advance Notice will include a description of the housing, the qualifications for tenancy or ownership, a copy of the application, and the name of a developer representative who can answer questions and provide additional information about the application process.

4.2 Community Meetings.

During the Advance Notice Period, the Vertical Developer shall conduct at least two (2) informational meetings in the Bayview Hunters Point area to answer questions and provide information to community residents about the housing opportunities that are becoming available at the Shipyard and other related matters described in the Advance Notice required in Section 4.1.

4.3 Community Assistance and Information Services.

The Vertical Developer shall provide Bayview Hunters Point area residents with information and other assistance to enable them to qualify for the For-Rent and For-Sale Residential Units. This information and other assistance, developed in collaboration with, and approved by, the Agency, shall include, but is not limited to, referrals to government agencies, lending institutions, and other organizations that may be able to provide financial and other assistance to qualified applicants.

Section 5. For-Rent Affordable Housing Units.

5.1 Procedures for Initial Rentals of For-Rent Affordable Housing Units.

(a) Affirmative Marketing Obligations.

(1) Prior to the initial rental of For-Rent Affordable Housing Units, the Vertical Developer shall advertise in media directed to different ethnic groups in San Francisco including, but not limited to, Asian Week, Chinese Times, El Bohemio, El Mensajero, Hokubei Mainichi, Horizontes, Korea Times, Metro Reporter Group, New Bayview, New Fillmore, Nichi Bei Times, and Philippine News. The Agency reserves the right to modify this list from time to time to adequately reflect diverse ethnicities and to allow for media which no longer exist; provided, however, that the list of required advertising media shall not exceed fifteen (15) publications. Advertisements shall be published in the predominant language of the ethnic group served by each applicable publication.

(2) Print ads shall be published at least twice in each publication that has a weekly circulation, and at least once in all other publications. Ads must be published prior to the Vertical Developer's conducting the lottery described in Section 5.1(c) below for the initial rental of For-Rent Affordable Housing Units in the applicable Residential Project.

(3) The Vertical Developer shall prepare and provide to the Agency for its review and approval a copy of the proposed advertisement described in Section 5.1(a)(2) above at least sixty (60) days prior to conducting the lottery described in Section 5.1(c) below for the initial rental of For-Rent Affordable Housing Units. The Agency's approval rights are limited to determining compliance with Section 5.1(a)(4) below. The Agency will approve or disapprove the proposed advertisement within five (5) business days of receipt. Failure by the Agency to either approve or disapprove the proposed advertisement within such five (5) day period shall be deemed approval.

(4) Print advertisements shall be no less than four inches (4") by six inches (6") in size. Each print advertisement shall include the U.S. Department of Housing and Urban Development Fair Housing logo and the words "Equal Housing Opportunity." The Vertical Developer shall include models of different races and ethnic background in all its pictorial advertising that includes models.

(b) Occupancy Priorities. In the initial rental of For-Rent Affordable Housing Units, the Vertical Developer shall give the following occupancy priorities (the "Occupancy Priorities"):

(1) **Hunters Point Certificate Holders.** The Vertical Developer shall give first-priority preference to Certificate Holders of Hunters Point Residential A and C Certificates each in the manner described in Section 5.1(c)(7) below.

- (2) Western Addition Certificate Holders. The Vertical Developer shall give second-priority preference to Certificate Holders of Western Addition Residential A and C Certificates, each in the manner described in Section 5.1(c)(7) below.
 - (3) Rent Burdened or Assisted Housing Residents Who Are San Francisco Residents. The Vertical Developer shall give a third-priority preference to persons paying more than 50% of their income for housing, or persons residing in public housing or Project-Based Section 8 housing, who are San Francisco Residents, in the manner described in Section 5.1(c)(7) below.
 - (4) San Francisco Residents. The Vertical Developer shall give fourth-priority preference to San Francisco Residents in the manner described in Section 5.1(c)(7) below.
 - (5) Members of the general public.
- (c) Rental Procedures/Lottery.
- (1) The Vertical Developer shall determine priority for occupancy of For-Rent Affordable Housing Units according to the Lottery system described in this Section 5.1(c).
 - (2) The Vertical Developer shall conduct a separate Lottery for each Residential Project containing For-Rent Affordable Housing Units.
 - (3) At least ninety (90) days prior to conducting the Lottery for For-Rent Affordable Housing Units in a Residential Project the Vertical Developer shall provide to the Agency the Marketing Information applicable to such Residential Units, together with a notice stating the date on which the Vertical Developer intends to start leasing such Residential Units.
 - (4) The Agency shall assist the Vertical Developer in notifying Certificate Holders of the availability of For-Rent Affordable Housing Units by providing the Vertical Developer a list of the names and addresses of Certificate Holders to notify regarding the housing opportunity and the application and Lottery process. The Vertical Developer shall provide the Agency with a list of all responding Certificate Holders, as well as providing information on each Certificate Holder's status in the application process.
 - (5) After completing the Affirmative Marketing Obligations outlined above, but no earlier than three (3) weeks after the first day on

which the Vertical Developer will accept applications, the Vertical Developer shall combine applications from all applicants, including Certificate Holders, if any, Rent Burdened or Assisted Housing Residents, San Francisco Residents, and members of the general public into one Lottery for each Residential Project.

- (6) The Vertical Developer shall select potential tenants at random from the combined pool of applicants by selecting all applicants submitting to the Lottery. Each applicant will be assigned a number in the order selected, . (the "Lottery List").
- (7) The Vertical Developer shall then identify any applicants entitled to an Occupancy Priority and rank all applicant on the Lottery List according to the preference categories in Section 54.1(b) above, and within each category in the order in which their name was selected for the Lottery List. This prioritized list shall be referred to as the "Potential Tenant List." The Vertical Developer shall provide the Agency with the Potential Tenant List within three (3) days of its creation.
- (8) Within thirty (30) days of the creation of the Potential Tenant List, unless otherwise mutually agreed by the Vertical Developer and the Agency, the Vertical Developer shall, determine the eligibility of as many households on the Potential Tenant List as there are available For-Rent Affordable Housing Units in a particular Residential Project (*i.e.*, one household per available For-Rent Affordable Housing Unit) in the order of priority on the Potential Tenant List, taking into account income and household size restrictions for the For-Rent Affordable Housing Units in each Residential Project, and applying all such other Vertical Developer tenant selection criteria consistent with this Exhibit I so as to fill all of the For-Rent Affordable Housing Units. The Vertical Developer shall then inform all eligible tenants so selected of the availability of For-Rent Affordable Housing Units in the particular Residential Project.
- (9) All applicants from the Potential Tenant List, shall have a reasonable opportunity to view either the actual Residential Unit for which the individual/household is qualified, or a model or other Residential Unit in that Residential Project which is substantially similar to the Residential Unit which the individual/household is qualified to occupy. All applicants from the Potential Tenant List shall then have at least three (3) days from and including the reasonable opportunity to view a Residential Unit above within which to notify the Vertical Developer of his/her intention to rent a

For-Rent Affordable Housing Unit and take all other steps necessary in accordance with the Marketing Information to secure such For-Rent Affordable Housing Unit.

(d) Tenant Income Eligibility. The required tenant income levels for each For-Rent Affordable Housing Unit in each applicable Residential Project shall be determined solely according to the requirements of Exhibit C to the Housing Program, which shall be recorded against each such Residential Project in accordance with the Housing Program.

(e) Rental Charge Restrictions. The rental rates for For-Rent Affordable Housing Units in each applicable Residential Project shall be determined solely according to the requirements of Exhibit C to the Housing Program, which shall be recorded against each such Residential Project in accordance with the Housing Program.

5.2 Procedures for Subsequent Rentals of Vacant For-Rent Affordable Housing Units.

(a) Affirmative Marketing Obligations. The Vertical Developer shall make good faith efforts to advertise the periodic vacancy of For-Rent Affordable Housing Units in a manner designed to reach diverse ethnic populations.

(b) Occupancy Priorities.

In the subsequent rental of vacant For-Rent Affordable Housing Units, the Vertical Developer shall give Occupancy Priorities in the order outlined in Section 5.1(b) above, first to persons in each category on the Potential Tenant List and then to persons in each category who request to be included on the waiting list following completion of Rent-Up of such Residential Units.

(c) Disqualification of Person on the Potential Tenant List.

(1) A Certificate Holder, Rent Burdened or Assisted Housing Resident, or San Francisco Resident on the Potential Tenant List or the waiting list of a Residential Project shall no longer be entitled to maintain the individual's/household's priority position on such list upon occurrence of any of the following:

(A) The individual/household is offered, but does not rent a For-Rent Affordable Housing Unit that the individual/household is eligible to occupy (based on income and Household Size);

(B) The income of the individual/household is too high for that individual/household to qualify for any For-Rent Affordable Housing Unit available in the particular Residential Project; or

(C) The individual/household fails to satisfy the Vertical

Developer's tenant selection criteria applicable to the particular Residential Project, applied in accordance with all applicable local, state and federal fair housing laws.

Section 6. For-Sale Affordable Housing Units.

6.1 Procedures for the Initial Sales of For-Sale Affordable Housing Units.

(a) Affirmative Marketing Obligations.

(1) Prior to the initial sale of For-Sale Affordable Housing Units, the Vertical Developer shall advertise in media directed to different ethnic groups in San Francisco including, but not limited to, Asian Week, Chinese Times, El Bohemio, El Mensajero, Hokubei Mainichi, Horizontes, Korea Times, Metro Reporter Group, New Bayview, New Fillmore, Nichi Bei Times, and Philippine News. The Agency reserves the right to modify this list from time to time to adequately reflect diverse ethnicities and to allow for media which no longer exist; provided, however, that the list of required advertising media shall not exceed fifteen (15) publications. Advertisements shall be published in the predominant language of the ethnic group served by each applicable publication.

(2) Print ads shall be published at least twice in each publication that has a weekly circulation, and at least once in all other publications. Ads must be published prior to the Vertical Developer's conducting the lottery described in Section 6.1(c)(6) below for the initial sale of For-Sale Affordable Housing Units in the applicable Residential Project.

(3) The Vertical Developer shall prepare and provide to the Agency for its review and approval a copy of the proposed advertisement described in Section 6.1(a)(2) above at least sixty (60) days prior to accepting applications for the initial sale of For-Sale Affordable Housing Units. The Agency's approval rights are limited to determining compliance with Section 6.1(a)(4) below. The Agency will approve or disapprove the proposed advertisement within five (5) business days of receipt. Failure by the Agency to either approve or disapprove the proposed advertisement within such five (5) day period shall be deemed approval.

(4) Print advertisements shall be no less than four inches (4") by six inches (6") in size. Each print advertisement shall include the U.S. Department of Housing and Urban Development Fair Housing logo and the words "Equal Housing Opportunity." The Vertical Developer shall include models of different races and ethnic background in all its pictorial advertising that includes models.

(b) Occupancy Priorities.

The Vertical Developer shall use the Occupancy Priorities in Section 5.1(b) in the initial sale of For-Sale Affordable Housing Units.

(c) Sales Procedures.

(1) At least one hundred eighty (180) days prior to the initial sale of a For-Sale Affordable Housing Unit, the Vertical Developer shall provide to the Agency the Marketing Information applicable to such Residential Units.

(2) The Agency shall assist the Vertical Developer in informing Certificate Holders of the availability of For-Sale Affordable Housing Units by providing the Vertical Developer a list of the names and addresses of Certificate Holders to notify regarding the housing opportunity and the application and lottery process. The Vertical Developer shall provide the Agency with a list of all responding Certificate Holders, as well as providing information on each Certificate Holder's status in the application process.

(3) The Vertical Developer, in cooperation with the Agency, shall conduct at least two (2) public informational meetings regarding the sale of For-Sale Affordable Housing Units in each Residential Project. Each meeting shall be advertised in conjunction with the advertising required under Section 6.1(a). Each meeting shall be open to persons potentially interested in the purchase of a For-Sale Affordable Housing Unit. At each meeting, the Vertical Developer and the Agency shall describe the following:

- (a) The number and type of For-Sale Affordable Housing Units to be offered;
- (b) The income and purchase price restrictions applicable to each available Residential Unit;
- (c) The resale restrictions applicable to each available Residential Unit, including the Second Lien Documents to be executed by each purchaser;
- (d) The anticipated schedule for marketing and selling such Residential Units; and
- (e) Information on covenants, conditions and restrictions; homeowner's association dues; Mello-Roos assessments; and proposed rules of the homeowners' association applicable to such Residential Units.

(4) The Vertical Developer may, at its discretion, accept pre-applications from interested purchasers and may pre-qualify purchasers of For-Sale Affordable Housing Units according to the occupancy restrictions applicable to a particular Residential Unit and the application of such other tenant selection criteria permitted under this Exhibit I.

(5) The purchase price for each unit type shall be set based on the Affordable Purchase Price for each For-Sale unit no later than three (3) days and no earlier than thirty (30) days prior to the lottery.

(6) The Vertical Developer shall conduct a lottery of all interested purchasers, including any potential purchasers that have been pre-qualified by the Vertical Developer, as follows:

- (a) The Vertical Developer shall conduct a separate lottery for each Residential Project containing For-Sale Affordable Housing Units.
- (b) The Vertical Developer shall combine all Certificate Holders, Rent Burdened or Assisted Housing Residents, San Francisco Residents and applications from members of the general public into one lottery for each Residential Project.
- (c) The Vertical Developer shall select potential purchasers at random from the combined pool of applicants, by selecting all applicants, and shall prioritize potential purchasers in the order selected into an initial list of potential purchasers (the "Lottery List").
- (d) The Vertical Developer shall then prioritize names on the Lottery List according to the Occupancy Priorities in Section 5.1(b). This newly prioritized list shall be referred to as the "Potential Purchaser List." The Vertical Developer shall provide the Agency with the Potential Purchaser List within three (3) days of its creation.
- (e) Within thirty (30) days of the creation of the Potential Purchaser List, unless otherwise mutually agreed by the Vertical Developer and the Agency, the Vertical Developer shall determine the eligibility of enough households on the Potential Purchaser List as there are available For-Sale Affordable Housing Units in a particular Residential Project (*i.e.*, one household per available For-Sale Affordable Housing Unit) in the order of priority on that list, taking into account income and household size restrictions for the For-Sale Affordable Housing Units in each Residential Project, and applying such other purchaser selection criteria consistent with this Exhibit I. The Vertical Developer shall then inform that number of eligible purchasers so selected of the availability of Residential Units in the particular Residential Project. The Vertical Developer's determination of Purchaser Eligibility is subject to a mortgage lender's approval of each potential

purchaser.

(d) Purchaser Income Eligibility and Sales Price Restriction. The income levels for purchasers of, and sales prices for, each For-Sale Affordable Housing Unit in each Residential Project shall be determined solely according to the requirements of Exhibit D to the Housing Program. Exhibit D, indicating the types of For-Sale Affordable Housing Units in each applicable Residential Project, shall be recorded against each Residential Project containing For-Sale Affordable Housing Units in accordance with the Housing Program.

6.2 Procedures for Resales of For-Sale Affordable Housing Units. All obligations of the owners of For-Sale Affordable Housing Units with respect to the resale of For-Sale Affordable Housing Units, including Occupancy Priorities and resale procedures, are contained in the Second Lien Documents. Purchaser income eligibility and sales price restrictions applicable to the resale of For-Sale Affordable Housing Units shall be determined solely according to the requirements of Exhibit D to the Housing Program.

Section 7. For-Rent Market Rate Residential Units.

7.1 Procedures for the Initial Rental of For-Rent Market Rate Residential Units.

(a) Affirmative Marketing Obligations.

(1) Prior to the initial rental of For-Rent Market Rate Residential Units, the Vertical Developer shall advertise in media directed to different ethnic groups in San Francisco including, but not limited to, Asian Week, Chinese Times, El Bohemio, El Mensajero, Hokubei Mainichi, Horizontes, Korea Times, Metro Reporter Group, New Bayview, New Fillmore, Nichi Bei Times, and Philippine News. The Agency reserves the right to modify this list from time to time to adequately reflect diverse ethnicities and to allow for media which no longer exist; provided, however, that the list of required advertising media shall not exceed fifteen (15) publications. Advertisements shall be published in the predominant language of the ethnic group served by each applicable publication.

(2) Print ads shall be published at least twice in each publication that has a weekly circulation, and at least once in all other publications. Ads must be published at least ten (10) days prior to the Vertical Developer's ceasing to accept applications for the initial rental of For-Rent Market Rate Residential Units in the applicable Residential Project.

(3) The Vertical Developer shall prepare and provide to the Agency for its review and comment only a copy of the proposed advertisement described in Section 7.1(a)(2) above at least thirty (30) days prior to accepting applications for the initial rental of For-Rent Market Rate Residential Units. The Agency's review and comment rights are limited to those items in Section 7.1(a)(4) below.

(4) Print advertisements shall be no less than four inches (4") by six inches (6") in size. Each print advertisement shall include the U.S. Department of Housing and

Urban Development Fair Housing logo and the words "Equal Housing Opportunity." The Vertical Developer shall include models of different races and ethnic background in all its pictorial advertising that includes models.

(b) Occupancy Priorities.

In the initial rental of For-Rent Market Rate Residential Units, the Vertical Developer shall use the occupancy priorities in Section 5.1(b).

(c) Rental Procedures.

(1) At least ninety (90) days prior to accepting applications for For-Rent Market Rate Residential Units, the Vertical Developer shall provide to the Agency the Marketing Information applicable to such Residential Units.

(2) The Agency shall assist the Vertical Developer in notifying Certificate Holders by providing the Vertical Developer a list of Certificate Holders to notify regarding the housing opportunity, giving the Certificate Holders the possibility for submitting rental applications and Income Verification Information. The Vertical Developer shall provide the Agency with a list of all responding Certificate Holders, as well as providing information on each Certificate Holder's status in the application process.

(3) No later than thirty (30) days from the Vertical Developer's receipt of the Agency's provision of the list of Certificate Holders under Section 7.1(c)(2), the Vertical Developer shall inform both the Agency and Certificate Holders as to which Certificate Holders from the list provided by the Agency are eligible to occupy the applicable For-Rent Market Rate Residential Units.

7.2 Procedures for Subsequent Rentals of Vacant For-Rent Market Rate Residential Units.

(a) Affirmative Marketing Obligations. The Vertical Developer shall make good faith efforts to advertise the periodic vacancy of For-Rent Market Rate Residential Units in a manner designed to reach diverse ethnic populations.

(b) Occupancy Priorities.

(1) Certificate Holders and San Francisco Residents shall be entitled to preference on the waiting list for the subsequent rentals of vacant of For-Rent Market Rate Rental Units, as described in Section 7.2(c) below.

(c) Rental Procedures.

(1) The Vertical Developer shall maintain a waiting list for occupancy of For-Rent Affordable Housing Units in each Residential Project containing such Residential

Units. The waiting list shall provide a priority for Certificate Holders and San Francisco residents who expressed an interest in renting a For-Rent Market Rate Residential Unit prior to the Rent-Up of such Residential Units, and a second priority for Certificate Holders and San Francisco residents who express an interest in such Residential Units subsequent to the Rent-Up of such Residential Units.

(2) A Certificate Holder or San Francisco Resident on such waiting list shall no longer be entitled to maintain the individual's/household's priority position on the waiting list upon occurrence of either of the following:

(A) The individual/household is offered a For-Rent Market Rate Residential Unit which the individual/household is eligible to occupy (based on Household Size), and the individual/household does not rent such Residential Unit; or

(B) The individual/household fails to satisfy the Vertical Developer's tenant selection criteria applicable to the particular Residential Units consistent with all applicable local, state and federal fair housing laws.

Section 8. For-Sale Market Rate Residential Units.

8.1 Procedures for Initial Sales of For-Sale Market Rate Residential Units.

(a) Affirmative Marketing.

(1) Prior to the initial sale of For-Sale Market Rate Residential Units, the Vertical Developer shall advertise in media directed to different ethnic groups in San Francisco including, but not limited to, Asian Week, Chinese Times, El Bohemio, El Mensajero, Hokubei Mainichi, Horizontes, Korea Times, Metro Reporter Group, New Bayview, New Fillmore, Nichi Bei Times, and Philippine News. The Agency reserves the right to modify this list from time to time to adequately reflect diverse ethnicities and to allow for media which no longer exist; provided, however, that the list of required advertising media shall not exceed fifteen (15) publications. Advertisements shall be published in the predominant language of the ethnic group served by each applicable publication.

(2) Print ads shall be published at least twice in each publication that has a weekly circulation, and at least once in all other publications. Ads must be published prior to the Vertical Developer's acceptance of any applications for the initial rental of For-Sale Market Rate Residential Units in the applicable Residential Project.

(3) The Vertical Developer shall prepare and provide to the Agency for its review and comment only a copy of the proposed advertisement described in Section 8.1(a)(2) above at least thirty (30) days prior to accepting applications for the initial rental of For-Sale Market Rate Residential Units. The Agency's review and comment rights are limited to those items in Section 8.1(a)(4) below.

(4) Print advertisements shall be no less than four inches (4") by six inches (6") in size. Each print advertisement shall include the U.S. Department of Housing and Urban Development Fair Housing logo and the words "Equal Housing Opportunity." The Vertical Developer shall include models of different races and ethnic background in all its pictorial advertising that includes models.

(b) Occupancy Priorities.

(1) Certificate Holders. In the initial sale of For-Sale Market Rate Residential Units, the Vertical Developer shall give a first-priority preference to Hunters Point Certificate Holders, Western Addition Certificate Holders, and then to San Francisco Residents as further described in Section 8.1(c)(3) below.

(c) Sales Procedures.

(1) The Vertical Developer shall notify the Agency at least one hundred and eighty (180) days prior to accepting applications for the sale of For-Sale Market Rate Residential Units in a particular Residential Project.

(2) The Agency shall assist the Vertical Developer in informing Certificate Holders of the availability of For-Sale Market Rate Residential Units by providing the Vertical Developer a list of the names and addresses of Certificate Holders to notify regarding the housing opportunity. Each Certificate Holder shall be responsible for notifying the Vertical Developer of a desire to purchase a For-Sale Market Rate Residential Unit.

8.2 Procedures for Subsequent Sales of For-Sale Market Rate Residential Units. This Exhibit I does not impose any restrictions on the subsequent sales of For-Sale Market Rate Residential Units.

Section 9. Reporting Requirements.

The Vertical Developer shall comply with the following reporting requirements, in addition to any other requirements imposed by the funding source for the development of Market Rate Residential Units or Affordable Housing Units.

9.1 For-Rent Affordable Housing Units.

(a) Within ten (10) days after the execution of a rental agreement for the last For-Rent Affordable Housing Unit in a particular Residential Project, the Vertical Developer shall provide to the Agency a report on the status of each Certificate Holder on the Potential Tenant List, and a rent roll specifying each Residential Unit number, Residential Unit size, number of occupants, affordability designation, and rent.

(b) The Vertical Developer shall provide to the Agency quarterly reports, no later than the 15th day of the month, which indicate the following information for the preceding

quarter:

(1) The number of individuals/households on the waiting list for a particular Residential Project containing For-Rent Affordable Housing Units;

(2) With respect to Certificate Holders, Rent Burdened or Assisted Housing Residents and San Francisco Residents:

(A) The names of current Certificate Holders, Rent Burdened or Assisted Housing Residents, and San Francisco Residents on the waiting list for each such Residential Project and the date on which each such name was added to the waiting list;

(B) The names of Certificate Holders, Rent Burdened or Assisted Housing Residents, and San Francisco Residents who leased Residential Units during the preceding quarter; and

(C) If applicable, the reason why any Certificate Holder, Rent Burdened or Assisted Housing Resident, or San Francisco Resident on the waiting list did not rent an available For-Rent Affordable Housing Residential Unit (*e.g.*, not income-eligible, household size not appropriate for the Residential Unit).

(3) The Residential Unit number and date of leasing of each Residential Unit rented during the preceding quarter.

(4) The number of names added to and removed from each waiting list during the preceding quarter.

(c) The Vertical Developer shall provide to the Agency, in the quarterly report, a current waiting list for each such Residential Project, together with a narrative summary of each case in which a Certificate Holder was denied occupancy of a For-Rent Affordable Housing Unit, and the grounds for such denial (*e.g.*, not income eligible, household size not appropriate for the available Residential Unit size).

9.2 For-Sale Affordable Housing Units. Within ten (10) days following the close of escrow of all For-Sale Affordable Housing Units in a particular Residential Project, the Vertical Developer shall provide to the Agency a report on the status of each Certificate Holder on the Potential Purchaser List, and a sales roll specifying each Residential Unit number, Residential Unit size, number of occupants, affordability designation, and sales price.

9.3 For-Rent Market Rate Residential Units.

(a) Within ten (10) days after the execution of a rental agreements for ninety percent (90%) of the total number For-Rent Market Rate Residential Units in a particular Residential Project, the Vertical Developer shall provide to the Agency a report on the status of each Certificate Holder who has applied to rent such Residential Units.

(b) The Vertical Developer shall provide to the Agency annual reports that indicate the following:

(1) A copy of the current waiting list for each Residential Project containing For-Rent Market Rate Residential Units, together with a narrative summary of any Certificate Holders which were denied occupancy of a For-Rent Market Rate Housing Unit, and the grounds for such denial (*e.g.*, not income eligible, household size not appropriate for the available Residential Unit size).

(2) With respect to Certificate Holders:

(A) The names of current Certificate Holders on the waiting list for each such Residential Project and the date on which each Certificate Holder's name was added to the waiting list;

(B) The names of Certificate Holders who leased Residential Units during the preceding year;

(C) If applicable, the reason why any Certificate Holder on the waiting list did not rent an available For-Rent Market Rate Residential Unit (*e.g.*, household size not appropriate for the Residential Unit).

(3) The Residential Unit number and date of leasing of each Residential Unit rented during the preceding year.

(4) The number of names added to and removed from each waiting list during the preceding year.

9.4 For-Sale Market Rate Residential Units. Within ten (10) days after execution of a purchase agreement for ninety percent (90%) of For-Sale Market Rate Residential Units in a particular Residential Project, the Vertical Developer shall provide to the Agency a report regarding the status of each Certificate Holder who applied for the purchase of any such Residential Unit.

ATTACHMENT 23

COMMUNITY OWNERSHIP, FINANCING, AND BENEFITS

This Community Ownership, Financing and Benefits Program (“Enhanced Community Benefits Program”) is attached to and made a part of the Disposition and Development Agreement (the “Agreement”) for Hunters Point Shipyard, Phase 1. Capitalized terms not defined in this Enhanced Community Benefits Program have the meanings given to them in the Agreement.

Section 1. Community Facilities Parcels

Section 1.1 Uses and Selection. The Community Facilities Parcels (also known as the Community Facility Parcels) are comprised of a total of six (6) acres of land in Phase 1 of the Shipyard. The Community Facilities Parcels will be used to provide, preserve and leverage such critical local resources as social services, education and other community services as determined by the Agency in collaboration with the CAC and the BVHP Representative Entity. As guiding principles, these Community Facilities Parcels should be used in a manner that will (1) enhance the overall quality of life of residents at the Shipyard and in the greater Bayview Hunters Point Area (meaning areas encompassed within the 94124, 94134 and 94107 zip codes as of the Effective Date of the Agreement, defined herein as the “BVHP Area”) and (2) support the creation of a vibrant new Shipyard neighborhood.

Following approval of the DDA, the Agency and the Developer will work in collaboration with the CAC to undertake a planning process that will set forth, among other things, the range of acceptable uses for the Community Facilities Parcels on Parcel A-1. As set forth in Section 6.6(c)11 of the DDA, the development of a plan for such parcels will be a condition to the Close of Escrow on Parcel A-1.

Following approval of the DDA, the Agency and the Developer will work in collaboration with the CAC to undertake a planning process that will set forth, among other things, the range of acceptable uses for the Community Facilities Parcels on Parcel B-1. As set forth in Section 6.6(c)(11) of the DDA, the development of a plan for such parcels will be a condition to the Close of Escrow on Parcel B-1.

Section 1.2 Developer’s Community Facilities Parcels Obligations. In addition to its obligation to collaborate with the Agency and the CAC to develop and undertake a planning process as specified in Section 1.1, Developer is also responsible, in accordance with the DDA and the Infrastructure Plan, for providing the necessary Horizontal Improvements to Community Facility Parcels to create serviceable lots, including rough grading with positive slope(s) enabling drainage towards the street, and not across interior parcel lines. Community Facilities Parcels will be created with the construction of new street segments and finished with an approved streetscape. Wet and dry utilities construction will include extending these services to each parcel

appropriately sized for the expected land uses determined through the process set forth in Section 1.1, above.

Section 1.3. Development of Community Facilities Parcels. The Agency and the community view the Community Facilities Parcels as an integral long-term community benefit for the Bayview Hunters Point Area and the City as a whole. In light of the foregoing, the Agency will identify certain land use restrictions, based on land uses determined in consultation with the CAC as further described in Section 1.1, above, for the Community Facilities Parcels which shall ensure that such parcels shall be dedicated to community purposes in perpetuity. The development of the Community Facilities Parcels will be determined by the Agency as part of the collaborative planning process with the CAC and the BVHP Representative Entity, as set forth below.

Section 2. Establishment of a Quasi-Public Entity

Section 2.1. Initial Formation. The Agency's staff will work with the CAC and other community groups in the BVHP Area to develop a plan, subject to Commission approval, for establishing a quasi-public entity representing the BVHP Area (the "BVHP Representative Entity") that, in collaboration with the CAC, will be charged with analyzing community needs and making recommendations to the Agency Commission on the use of Agency's net land sale proceeds, as referenced in Section 3, to address those needs. It is anticipated that a portion of net land sale proceeds will be administered by this quasi-public entity. The Agency will work with the CAC to identify potential sources for pre-funding the BVHP Representative Entity, including without limitation, grants from governmental entities, private foundations or other sources.

Section 2.2. Key Principals. While further analysis and community input will be necessary to determine the precise nature (i.e., whether it is a community foundation, a public benefit corporation, etc.) and the role of the BVHP Representative Entity, as well as its relationship to the Agency, the BVHP Representative Entity will be formed according to the following key principles:

(a) The governing body will have meaningful community representation, with members recruited and selected through an open and fair public process;

(b) As a quasi-public body, the BVHP Representative Entity will operate in conformance with all applicable laws and regulations governing conflicts of interest and open public meetings;

(c) The BVHP Representative Entity will be charged with making recommendations that ensure the BVHP Area and not just a few individuals benefit from the use of the Agency's net land sale proceeds;

(d) Transparency and public accountability will necessarily guide all operations and actions of the BVHP Representative Entity;

(e) Use of funds will focus on building the capacity of existing community-based entities wherever possible; and

(f) Use of funds will be geared towards leveraging additional outside sources of funds to the maximum extent possible.

Section 3. Use of Agency Land Value and Agency Land Return

Section 3.1 Agency Account. The Agency shall establish and maintain a separate account or sub-account for the deposit of all net revenues (net of the Agency's administrative costs) received by the Agency under Attachments 25 and 26 of the DDA. One hundred percent (100%) of the net revenues shall be reinvested to benefit the BVHP Area ("Permitted Uses"), in consultation with the CAC and the BVHP Representative Entity and subject to Commission approval of each Community Benefits Budget (as described below), which Community Benefits will be separate from and in addition to any obligations of Lennar/BVHP to provide certain community benefits under the DDA. As set forth in Section 6.6(b)(7) of the DDA, the development of a plan for consultation with the CAC and the BVHP Representative Entity will be a condition to the Close of Escrow. Permitted Uses must: (a) benefit low- and moderate-income families; (b) eliminate blight; or (c) meet other urgent community development needs of the BVHP Area. The following activities have been suggested by the CAC as potential Permitted Uses:

(a) Financial and technical assistance for non-profit and for-profit community organizations and enterprises in acquiring and/or developing properties in the Shipyard, including, without limitation, assistance with respect to developing the Community Facilities Parcels;

(b) Financial assistance for construction and operation of additional community facilities;

(c) Affordable housing assistance, including without limitation using such funds to effectively reduce the maximum income levels for purchase or rental of the Affordable Housing Units through down payment assistance and other subsidies;

(d) Small business loan programs, including establishing a revolving loan fund;

(e) Additional financial assistance for existing job training, education, hiring and contractor selection programs;

(f) Community-based financial services;

(g) Childcare, youth and senior programs;

(h) Cultural and arts related programs;

- (i) Development of new programs or institutions required to implement the Redevelopment Plan;
- (j) Enhancements to infrastructure systems;
- (k) Enhancements to recreational and open space facilities and programs;
- (l) Leveraging such funds through available methods, such as CRA, COIN and foundation funding; and
- (m) Providing investments in Community Builders who undertake Vertical Development, either as a silent or an active partner.

As referenced in the Closing condition set forth in Section 6.6(c)(11), the Agency agrees to work with the CAC and the BVHP Representative Entity to develop and undertake a planning process by which the CAC and the BVHP Representative Entity will advise the Agency in the identification of Permitted Uses.

Section 3.2 Community Benefits Budget. Each fiscal year, Agency staff will prepare a budget detailing Permitted Uses for the following fiscal year ("Community Benefits Budget"), based on input from the CAC and BVHP Representative Entity, which will be presented to the Agency Commission for approval. Each Community Benefits Budget will set forth, among other things, the following items: (a) projected revenues for the upcoming fiscal year; (b) line item allocations to Permitted Uses, with projected schedules for payments; (c) expenditure priorities for selected Permitted Uses in the event that revenues are not sufficient to fund Permitted Uses fully; (d) cumulative receipts and disbursements; and (e) narrative discussion of the goals of each Permitted Use and progress made during the prior year towards the goals.

Section 3.3 Records and Reporting. The Agency shall maintain books and records of all receipts and disbursements related to the account in accordance with generally accepted accounting principles consistently applied, or in another auditable form (collectively, the "Records"). The Records shall be retained as "public" information. The Community Benefits Budget will be subject to annual audits, the results of which will be publicly disclosed.

ATTACHMENT 24

EQUAL OPPORTUNITY PROGRAM AND ADDITIONAL BUSINESS, EMPLOYMENT, CONSTRUCTION ASSISTANCE/OPPORTUNITIES AND COMMUNITY BENEFITS PROGRAM

Attachment 24 comprises two parts. The first, the Equal Opportunity Program, which is attached as Exhibit A, is the program customarily imposed by the Agency on developers in order to promote equal opportunity. The second, the Additional Business, Employment, Construction Assistance/Opportunities and Community Benefits Program, which is attached as Exhibit B, has been formulated specifically by Developer for the Shipyard in order to implement certain portions of the Conceptual Framework.

ATTACHMENT 24

EXHIBIT A

EQUAL OPPORTUNITY PROGRAM

This Equal Opportunity Program (the "EOP") is attached to and made a part of the Disposition and Development Agreement (the "Agreement") for Hunters Point, Phase 1 ("Phase 1"). Developer is bound by this Attachment as part of the obligations it assumes, and benefits it receives, under the Agreement.

Section 1. Purposes. The Agency and Developer agree that this EOP and its accompanying Riders and Attachments are designed to ensure that:

1.1 Persons and businesses that enter into disposition and development agreements with the Agency, that plan, design or construct improvements on sites initially purchased and assembled with Agency funds, or that occupy a site after its completion, provide equal opportunities to and do not discriminate against Minority Group Persons, women, or business enterprises owned by Minority Group Persons or women.

1.2 Developer, its prime contractor, all Subcontractors, and Retail Tenants of Developer recruit, employ and contract with all qualified individuals and businesses that are part of the work force and business community in San Francisco and the Bay Area.

Section 2. Definitions.

Terms not defined in this Attachment have the meanings given to them in the Agreement.

Agency means the staff of the Redevelopment Agency of the City and County of San Francisco responsible for ensuring that the EOP is implemented.

Agency Parcels means, collectively, the Agency Housing Parcels, Community Facility Parcels and Open Space, all of which are shown on the map attached as Attachment 2 to the Agreement.

Agreement has the meaning set forth in the Preamble.

Bayview Hunters Point Area or BVHP Area means that portion of the City and County of San Francisco located in zip code areas 94124, 94134 and 94107 as of the Effective Date of the Agreement, which comprise the neighborhoods most affected by closure of the Shipyard.

Business Day means a day other than Saturday, Sunday or a state or federal holiday.

Close of Escrow or Closing means the recordation of the grant deed evidencing the conveyance of all or a portion of the Project Site. There may be a separate Close or Escrow for Parcel A-1 and for Parcel B-1.

Commence Construction means the commencement of substantial physical construction

of the Horizontal Improvements as part of a sustained and continuous construction plan.

Consultant means a person or business that is a party to a professional service contract.

Contract means any agreement in excess of ten thousand dollars (\$10,000.00) between Developer, the general contractor, any prime contractors or any Subcontractor (regardless of tier) and a Person to provide or procure labor, materials, supplies or services, including a purchase order that requires installation of materials upon the Project Site or Agency Parcels covered by the Agreement. A "contract" does not include a loan transaction.

Contractor means Developer's general contractor, all prime contractors and all Subcontractors (regardless of tier) having a contract or subcontract in excess of ten thousand dollars (\$10,000.00) and who employ persons in a trade at the Project Site or Agency Parcels.

Controlled, for purposes of determining whether a business is an MBE or a WBE, means that the Minority Group Person(s), the woman or a combination of Minority Group Persons and women, as the context requires, shall (1) possess legal authority and power to manage business assets, good will and daily operations of the business; and (2) actively and continuously exercise such authority and power in determining the policies and in directing the operations of the business.

Economically Disadvantaged means a business that has not achieved the gross income threshold for the applicable industry specified below, calculated by averaging the gross income for the three most recent consecutive years. The gross income levels set forth below may be revised from time to time to reflect the Agency's then current policy regarding the criteria for determining Economically Disadvantaged businesses. Any such amendment shall be effective immediately upon written notification to Developer from the Agency. When a business is no longer Economically Disadvantaged, it is not an eligible M/WBE and it will not be counted towards meeting M/WBE goals.

<u>Industry</u>	<u>Gross Income</u>
Construction	\$14,000,000
Professional or Personal Services	2,000,000
Suppliers	2,000,000

EOP has the meaning set forth in the Preamble.

First Consideration means to make a genuine effort to consider local M/WBEs before looking elsewhere. Non-Local M/WBEs should be used to satisfy participation goals only if Local M/WBEs are not available or qualified, or if their bids or fees are significantly higher than those of the non-Local M/WBEs.

First Consideration for Employment means to offer a permanent position to individuals who are qualified for that position and who live in BVHP Area (or in San Francisco as the case may be) prior to offering the position to a qualified individual who does not live in

BVHP Area (or in San Francisco as the case may be).

Good Faith Efforts or **GFE** has the meaning set forth in Section 4.2 of Rider 2, and requires genuine good faith efforts to comply with the steps set forth in Section 4.2 of Rider 2.

Horizontal Improvements means the works of improvement described in the Infrastructure Plan to be constructed in or for the benefit of the Redevelopment Area.

Job Category means a group of similar jobs such as food and beverage supervisors, room cleaners and related workers, etc.

Joint Venture means two or more businesses acting as a Contractor and performing or providing services on a contract, in which each joint venturer combines property, capital, skill and/or knowledge. In order for the M/WBE component of a joint venture to be recognized the ownership interest must meet a 35 percent threshold; provided, that if the joint venture subcontracts to non-M/WBEs a percent of the work in excess of the percentage interest that the M/WBE has in the joint venture, the joint venture shall not be recognized as an M/WBE.

Local M/WBE means an Economically Disadvantaged, independent and continuing M/WBE that: (a) has fixed offices located within the geographic boundaries of the City and County of San Francisco; (b) is listed in the Permits and License Tax Paid File with a San Francisco Business Street address; and (c) possesses a current Business Tax Registration Certificate. Post office box numbers or residential addresses alone shall not suffice to establish a firm's status as local. To qualify as a local firm, the firm must have been located and doing business in San Francisco for at least six (6) months prior to the date of the Agreement.

Minority or Minority Group Person means:

American Indian or Alaska Native, which includes Alaska Indians, Inuits and Aleuts (any person having origins in the indigenous peoples of North America and who is an enrolled member of a federally-recognized tribe);

Asian (any person of Chinese, Japanese, Korean, Pacific Islander, Samoan, Filipino, Asian-Indian or South East Asian origins);

Black (any person having origins in any of the black racial groups of Africa); or

Latino (any person of Spanish culture with origins in Mexico or other Spanish speaking countries in Central or South America or the Caribbean Islands).

Minority-owned Business Enterprise (MBE) means an Economically Disadvantaged, independent, continuing and for-profit business, which performs a commercially useful function, and is owned and controlled by one or more Minority Group Persons residing in the United States or its territories.

Minority/Woman-owned Business Enterprise (M/WBE) means an Economically Disadvantaged, independent, continuing and for-profit business, which performs a commercially useful function, and is owned and controlled by one or more Minority Group Persons or women

residing in the United States or its territories.

Notice of Non-Compliance has the meaning set forth in Section 5.7.

Notice of Non-Qualification has the meaning set forth in Section 5.6.

Owned, for purposes of determining if a business is an MBE or a WBE, means that the Minority Group Persons or women, as the context requires, possess an ownership interest of at least fifty-one percent (51%) of the business, possess incidents of ownership, such as an interest in profit and loss, equal at least to the required ownership interest percentage, and contribute capital, equipment and expertise to the business equal to at least the required ownership percentage.

Participation Goals has the meaning set forth in Section 6.1.

Person includes one or more individuals, partnerships, associations, organizations, corporations, cooperatives and legal representatives.

Project Site means that certain real property in the City more particularly described on Attachment 1 to the Agreement. The Project Site does not include the Agency Parcels.

Retail Tenant means a business at the Project Site or Agency Parcels, whether run by tenants, operators or concessionaires, and which supplies commodities or services to customers on its premises, including, but not limited to, stores, shops, hotels and eating and drinking businesses such as restaurants and bars.

Request for Arbitration has the meaning set forth in Section 9.2.

San Francisco Resident (Other Than a Person Previously Employed by Developer or Retail Tenant) means a person who establishes that she or he has lived in San Francisco for at least one week prior to submitting her or his initial application for employment with Developer.

San Francisco Resident (a Person Employed by Developer or Retail Tenant Prior to Assignment to the Project Site or Agency Parcels) means a person who had lived in San Francisco for at least six (6) months prior to the date she or he applied for a transfer to a position at the Project Site or Agency Parcels or the date she or he was assigned to work at the Project Site or Agency Parcels, whichever is earlier; or a person who establishes, to the satisfaction of the Agency, that she or he lived in San Francisco prior to applying for or being considered for a position with Developer or Retail Tenant at the Project Site or Agency Parcels.

Subcontract means an agreement between a Contractor and a person or entity pursuant to which the person or entity agrees to perform all or a portion of the services covered by a Contract.

Subcontractor means a person or entity that enters into a Subcontract.

Trade means all skilled construction trades, laborers and security guards.

Vertical Improvements has the meaning set forth in Attachment 18.

Woman-owned Business Enterprise (WBE) means an Economically Disadvantaged, independent, continuing and for-profit business, which performs a commercially useful function, and is owned and controlled by one or more women residing in the United States or its territories.

Section 3. Areas Covered. In addition to the matters directly addressed in this EOP, the equal opportunity obligations and requirements established herein cover:

3.1 The construction work force for the Horizontal Improvements upon the Project Site and Agency Parcels, and any additions or changes thereto. Training and employment obligations and requirements are set forth in Rider 1 attached hereto and incorporated herein by reference.

3.2 Minority- and Woman-owned Business Enterprises. These obligations and requirements are set forth in Rider 2 attached hereto and incorporated herein by reference.

3.3 Developer's permanent work force that occupies improvements on the Project Site and Agency Parcels after completion of construction and the permanent work force of Retail Businesses, with more than ten (10) employees, who lease space at the Project Site and Agency Parcels. These obligations and requirements are set forth in Rider 3 attached hereto and incorporated herein by reference.

Section 4. Obligation to Incorporate in Other Contracts.

4.1 Each Contract between Developer and a Consultant, a general contractor, a prime contractor or a Subcontractor (regardless of tier) shall incorporate and make binding on the parties to the contract Sections 1, 2, 3, 4.2, 9 and 11 of this Exhibit A and Riders 1 and 2 to this Exhibit A. Each contract or lease between Developer and a Retail Tenant shall incorporate and make binding on the parties to the contract or lease Sections 1, 2, 3, 4.2, 9 and 11 of this Exhibit A and Rider 3 to this Exhibit A. Any penalties or other monetary damages received by the Agency as a result of defaults under this Attachment 24 will be treated as revenues to the Agency subject to use within the BVHP Area as provided in Attachment 23.

4.2 There shall be no discrimination against or segregation of any person, or group of persons, on account of race, color, religion, creed, national origin or ancestry, sex, gender identity, age, marital or domestic partner status, sexual orientation or disability (including HIV or AIDS status) in the performance of this Agreement. Developer and each party to the contract will ensure that applicants are employed, and that employees are treated during employment, without regard to their race, color, religion, creed, national origin or ancestry, sex, gender identity, age, marital or domestic partner status, sexual orientation or disability (including HIV or AIDS status). Such action shall include, but not be limited to, the following: employment, upgrading, demotion, or transfer; recruitment or recruitment advertising; layoff or termination; rates of pay or other forms of compensation; selection for training, including apprenticeship; and provision of any services or accommodations to clients or the general public.

Section 5. Developer's Hiring Obligations.

5.1 This Section 5 applies to Developer's employees. Developer's obligations with respect to its work force on the Project Site and Agency Parcels are set forth in Rider 3.

5.2 Developer shall make Good Faith Efforts to fill vacancies in each job category in its work force (whether filled by new hire or promotion) from residents of the BVHP Area at a rate that reflects the ethnic and gender composition of the City and County of San Francisco.

5.3 Developer shall give First Consideration in Employment to residents of the BVHP Area; provided that, if a conflict arises, Developer's obligation under Section 5.2 shall take precedence over its obligation to give First Consideration in Employment under this Section 5.3.

5.4 During the period between the issuance of the Request for Proposals and the execution of the Agreement, Developer hired as follows:

<u>Job Category</u>	<u>Total</u>	<u>Amer. Indian</u>	<u>Asian/ Pacif. Islndr.</u>	<u>Black</u>	<u>Latino</u>	<u>Women</u>	<u>SF Res</u>	<u>BVHP Area Res</u>
1.								
2.								
3.								
4.								

5.5 Developer shall submit semi-annual reports to the Agency that show, for each job category of its employees, the total new hires, the ethnicity (each Minority group) of the new hires, the gender of the new hires, and the residence of new hires (San Francisco/non-San Francisco).

5.6 The Agency or Developer will resolve any dispute concerning the interpretation, implementation or alleged breach of this Section pursuant to Section 9 of this Exhibit A.

Section 6. Developer's Design and Other Professional Services Consultants.

6.1 **Participation Goals.** The Agency has made a finding that discrimination has occurred against businesses owned by women and Minority Group Persons. Accordingly, Developer and all professional and personal services contractors with contracts in excess of ten thousand dollars (\$10,000.00) shall make Good Faith Efforts to achieve the following goals, which have been designed to correct the effects of past discrimination:

MBE	twenty percent (20%)
WBE	eighteen percent (18%)

Only firms certified as MBEs, WBEs or W/MBEs (a combination of MBEs and WBEs) in accordance with Section 6 of Rider 2 to this Exhibit A will be counted toward meeting the above participation goals.

6.2 Developer and its Contractors shall give First Consideration to local M/WBEs and comply with the Good Faith Efforts set forth in Section 4 of said Rider 2 to ensure that M/WBEs have an equal opportunity to compete for and participate in contracts for the planning and design of the Horizontal Improvements on the Project Site and Agency Parcels. This obligation covers all contracts involved in the Improvements and such tenant improvements, including professional service contracts, Consultant Contracts and Subcontracts. The prime contractors are responsible for ensuring that each of their Subcontractors meets these requirements.

6.3 Developer's total consultant costs are expected to amount to _____ dollars (\$ _____).

6.4 Prior to the execution of the Agreement, Developer has selected the following Consultants:

<u>Firm & Address</u>	<u>Ethnicity & Gender of Owners</u>	<u>Telephone</u>	<u>Work Product</u>	<u>Contract Amount</u>
1.				
2.				
3.				
4.				

*As of the date of the Agreement, ____% of Developer's Consultants are M/WBEs.

6.5 The following design and engineering Consultants have agreed to employ Workforce Investment Act-eligible trainees through a program under which the employer may receive tax credits:

	<u>Firm & Address</u>	<u>Contact Person</u>	<u>No. of Trainees</u>	<u>Dates for Hiring</u>
1.				
2.				
3.				
4.				

The consultant team is expected to employ the number of trainees indicated in the following schedule:

<u>Trainees</u>	<u>Consultant Fees</u>
0	\$ 0 - 249,999
1	250,000 - 399,999
2	400,000 - 599,999
3	600,000 - 999,999
4	\$1,000,000 - 1,999,999
5	\$2,000,000 or more

Section 7. Developer's Construction Contracts.

7.1 **Participation Goals.** The Agency has made a finding that discrimination has occurred against construction firms owned by women and Minority Group Persons. Accordingly, Developer and all construction Contractors with contracts in excess of ten thousand dollars (\$10,000.00) shall make Good Faith Efforts to achieve the following goals, which have been designed to correct the effects of past discrimination:

MBE	thirty-one percent (31%)
WBE	ten percent (10%)

Only firms certified as MBEs, WBEs or W/MBEs (a combination of MBEs and WBEs) in accordance with Section 6 of Rider 2 to this Exhibit A will be counted toward meeting the above

participation goals.

7.2 Developer and all such Contractors shall give First Consideration to local M/WBEs and comply with the Good Faith Efforts set forth in Section 4 of Rider 2 to this Exhibit A to ensure that M/WBEs have an equal opportunity to compete for and participate in contracts for the construction of the Horizontal Improvements upon the Project Site and Agency Parcels. This obligation covers all construction contracts and subcontracts involved in the improvements and such tenant improvements, including ancillary professional service Contracts, Consultant Contracts and subcontracts. The prime contractors are responsible for ensuring that each of their Subcontractors meets these requirements.

7.3 Developer's total cost of its construction contracts for improvements on the Project Site and Agency Parcels are expected to amount to _____ dollars (\$ _____).

7.4 Prior to the execution of the Agreement, Developer has selected the following construction Contractors (including general contractors):

<u>Firm & Address</u>	<u>Ethnicity & Gender of Owners</u>	<u>Telephone</u>	<u>Work Product</u>	<u>Contract Amount</u>
1.				
2.				
3.				
4.				
5.				

Section 8. Use and Occupancy of the Project Site.

8.1 Program for Attracting MBE/WBE Tenants.

(a) In determining the Retail Tenant mix, after consultation with the CAC, Developer will consider the impact on the community of certain retail businesses, such as liquor stores and businesses that create adverse environmental conditions; provided that Developer shall retain the sole right to make final selection decisions on Retail Tenant mix, rental rates, terms and conditions, financial qualifications and experience. Developer will work proactively with local jobs training programs in connection with the final Retail Tenant mix. Developer shall make Good Faith Efforts to lease space in the Vertical Improvements constructed upon the Project Site covered by the Agreement and intended for Retail Tenants to MBEs and WBEs

(b) Program for Generating M/WBE Interest. Developer commits to the following process to ensure good faith consideration of M/WBE Retail Tenants for utilization of the Project Site. Developer will designate a representative, either in-house or under contract, as the person or entity responsible for implementation and oversight of this process:

(1) Ninety (90) days prior to accepting applications from tenants, Developer shall invite representatives of the San Francisco Minority Business Development Center, U.S. Small Business Administration (SBA), Minority Enterprise Small Business Investment Corporations (MESBICs), Neighborhood Economic Development Corporations (NEDOs), San Francisco Economic Development Corporation, Minority chambers of commerce, local merchants associations and the Economic Development Division of the Agency to a meeting to discuss the business opportunity being offered, including information about the amount of space being offered, the type of Retail Tenant desired and the leasing agent, if any. The invitations should state the fact that Developer is seeking applications from M/WBEs.

(2) Publicize the availability of space and/or the business opportunity by such actions as participating in Minority and woman-oriented radio and television talk shows; making presentations to Minority chambers of commerce or holding a special meeting for the Minority chambers of commerce, and periodically issuing press releases to media oriented to ethnic Minority group persons and women. Developer shall publicize the availability of the space and/or the type of business opportunity by placing notices in the city's *Bid and Contract Opportunities* and advertisements in the *Small Business Exchange* and any other publications or organizations targeting the BVHP Area.

(3) Refer to one or more of the providers of management and technical assistance referred to above M/WBEs that do not initially meet Developer's business criteria.

(4) Notify the Agency when space is rented or leased to an M/WBE. The notification shall be submitted to the Agency within one (1) month of the date of execution of the lease or contract and shall include the following:

(A) name, title, ethnicity and gender of principals;

(B) name and address of business;

- (C) nature of business; and
- (D) amount of space and length of lease.

(5) Meet periodically with each M/WBE Retail Tenant to discuss any operating issues of concern to the M/WBE, to Developer or to both.

8.2 Business Preference Program. In accordance with the Agency's Preference Rules in the Redevelopment Plan, and with respect to businesses located in BVHP Area, as set forth in the Agreement, Developer will give priority consideration to the businesses that will be displaced from the Redevelopment Area and those businesses and entrepreneurial ventures located in the BVHP Area of the Redevelopment Area, as applicable, provided that such businesses comply with the land use requirements of the Redevelopment Plan and the criteria established by Developer for occupancy. However, Developer retains the sole right to make final selection decisions on business mix, rental rates, and terms and conditions including financial qualifications.

8.3 Reports. Annually, on the anniversary date of the leasing of the first premises intended for Retail Tenants on the Project Site, Developer shall provide the Agency with a report showing, for each Retail Tenant,

- (a) the name, square footage leased and whether the Retail Tenant is an MBE or a WBE;
- (b) Proof, as required by the Agency, that a Retail Tenant claiming to be an MBE or a WBE is in fact an MBE or a WBE; and
- (c) The name and square footage leased to each Retail Tenant who qualified under the Business Preference Program.

8.4 Arbitration of Disputes. The Agency and Developer may take any dispute concerning the interpretation, implementation or alleged breach of this Section 8 to arbitration pursuant to the arbitration provisions set forth in Section 9 of this Exhibit A.

8.5 Term. The Use and Occupancy provisions of this Section 8 shall commence if and when Developer becomes subject to an amended Agreement or new disposition and development agreement or owner participation agreement with respect to the construction of Vertical Improvements, and shall remain in effect so long as Developer is in the business of leasing space to Retail Tenants in the Project Site.

Section 9. Arbitration of Disputes.

9.1 Agency's right of enforcement. For purposes of enforcement, the Agency is and shall be the beneficiary of the obligations, requirements and agreements established by this Exhibit A, Riders 1, 2 and 3, and any equal opportunity plan created or developed pursuant to the Riders. The Agency is the beneficiary for itself, in its own right, and also for purposes of protecting the interest of the community, and other parties, public or private, in whose favor and for whose benefit such obligations, requirements or agreements have been provided.

Accordingly, the Agency shall have the right to enforce said obligations, requirements and agreements against Developer, the prime contractor, any Consultant, any Retail Tenant, any Subcontractor (regardless of tier), or any material supplier of the prime contractors or any Subcontractor, as well as any party who by contract also has the responsibility for enforcement of said obligations, requirements or agreements, e.g., breaching sub-Subcontractor against the Subcontractor, the prime contractors and Developer.

9.2 Initiating Arbitration; Request for Arbitration. Arbitration, as provided for in this Exhibit A and its accompanying Riders, shall be the exclusive procedure for resolving any dispute concerning the interpretation, implementation or alleged breach of this Exhibit A or its Riders. The Agency, Developer, its Consultant, prime contractor, any Subcontractor (excluding all Contractors or Consultants who were not awarded a contract) or any Retail Tenant may take any such dispute to arbitration by filing a Request for Arbitration with any member of the panel of arbitrators attached hereto as Rider 5. Prior to filing the Request, the complaining party may determine by telephone if a particular arbitrator is available to hear the matter. Where the Agency is not the complaining party, the Request shall be served on the Agency. Where the Agency is the complaining party, the Request shall be served on Developer and the non-compliant party (if not Developer) if such service can be achieved with reasonable effort. The Request shall be filed and served either by hand delivery or by registered or certified mail. The Request shall identify the entities involved in the dispute (e.g., the specific Subcontractor), and state the exact nature of the dispute and the relief sought. If the complaining party seeks a temporary restraining order and/or a preliminary injunction, the Request shall so state in the caption of the Request.

9.3 Effect of Service on Developer. Service on Developer of the Request for Arbitration or any notice provided for by this Exhibit A or any accompanying schedule shall constitute service of the Request or notice on all Consultants, prime contractors, Subcontractors, and Retail Tenants who are identified as being in alleged non-compliance in the Request for Arbitration. Developer shall promptly serve the Request or notice, by hand delivery or registered or certified mail, on all such Consultants, prime contractors, Subcontractors or Retail Tenants.

9.4 Parties' Participation. Developer shall require, by contract, that each of its Consultants, all prime contractors, all Subcontractors, and all Retail Tenants participate in any arbitration proceedings in which it is identified in the Request for Arbitration, and that each shall be bound by the outcome, including the decision of the arbitrator.

9.5 Arbitrator's Ability to Act. Except where a temporary restraining order is sought, the arbitrator with whom the Request was filed shall notify the Agency and Developer by telephone within forty-eight (48) hours if she or he is **not** available to act as arbitrator. Where a temporary restraining order is sought, such notice shall be provided within twenty-four (24) hours. If the arbitrator is not available, she or he shall immediately designate one of the other available members of the panel appearing on Rider 5 hereto to be the arbitrator.

9.6 Negotiations Prior to Arbitration. Prior to the filing and service of a Request for Arbitration, the parties to any arbitrable dispute shall meet and confer in an attempt to resolve the dispute. After the filing and the service of a Request for Arbitration, the parties shall negotiate in good faith for a period of ten (10) Business Days in an attempt to resolve the

dispute; provided that the complaining party may proceed immediately to arbitration, without engaging in such a conference or negotiations, if the facts could reasonably be construed to support the issuance of a temporary restraining order or a preliminary injunction (temporary relief). Whether the facts reasonably supported the issuance of temporary relief shall be determined by the arbitrator and shall not, under any circumstances, be determined by a court.

9.7 Setting of Arbitration Hearing. If the dispute is not settled within ten (10) Business Days, a hearing shall be held within ninety (90) days of the date of the filing of the Request for Arbitration, unless otherwise agreed by the parties or ordered by the arbitrator upon a showing of good cause; provided that, if the complaining party seeks a temporary restraining order, the hearing on the motion for a temporary restraining order shall be heard not later than two (2) Business Days after the filing of the Request for Arbitration, and provided further, if a party seeks a preliminary injunction, such motion shall be heard on fifteen (15) days' notice. The arbitrator shall set the date, time and place for the arbitration hearing(s) within the proscribed time periods by giving notice by hand delivery to the Agency and Developer; provided that, where a temporary restraining order is sought, the arbitrator may give notice of the hearing date, time and place to the Agency and Developer by telephone.

9.8 Discovery. In arbitration proceedings hereunder, discovery shall be permitted in accordance with Code of Civil Procedure § 1283.05.

9.9 Arbitration Remedies and Sanctions. Except as may otherwise be expressly provided in the Riders incorporated herein, the arbitrator may impose only the remedies and sanctions set forth below and only against the non-compliant party(ies):

(a) Order specific, reasonable actions and procedures, in the form of a temporary restraining order, preliminary injunction or permanent injunction, to mitigate the effects of the non-compliance and/or to bring Developer and/or its non-compliant Consultants, prime contractors, Subcontractors, or Retail Tenants into compliance.

(b) Require Developer, Consultants, prime contractors or Subcontractors to refrain from entering into new contracts related to work covered by the Agreement, or from granting extensions or other modifications to existing contracts related to work covered by the Agreement, other than those minor modifications or extensions necessary to enable completion of the work covered by the existing contract, with any non-compliant Consultant, the prime contractors or Subcontractor until such Consultant, prime contractors or Subcontractor provides assurances satisfactory to the Agency and Developer of future compliance with the applicable provisions of the Agreement.

(c) Direct Developer, Consultants, prime contractors, or Subcontractors to cancel, terminate, suspend or cause to be cancelled, terminated or suspended, any contract or lease or portion(s) thereof for failure of the Consultants, prime contractors, Subcontractors or Retail Tenant to comply with any of the equal opportunity/equal opportunity provisions of the Agreement. Contracts or leases may be continued upon the condition that a program for future compliance is approved by the Agency.

(d) Order conveyance of the Project Site where the Agency has refused to convey

the Project Site pursuant to Section 10 of this Exhibit A. The arbitrator may condition conveyance on Developer completing specific remedial actions or agreeing to take specific remedial actions after the conveyance.

(e) Award back and front pay to those who were not hired or lost hours of work as a result of the failure of Developer, any Consultant, prime contractors or any Subcontractor to make the required Good Faith Efforts to meet the employment goals established herein. No front pay award shall extend beyond the period that the non-compliant party performs work at the Project Site and Agency Parcels.

(f) If Developer, a Consultant, the general contractor, a prime contractor, a Subcontractor or a Retail Tenant is found to be in willful breach of its obligations hereunder, impose financial penalties not to exceed fifty thousand dollars (\$50,000.00) or ten percent (10%) of the base amount of the contract, whichever is less, for each such breach on the party responsible for the willful breach; provided that, in determining the amount of any financial penalty to be assessed, the arbitrator shall consider the financial capacity of the breaching party. No penalty shall be imposed pursuant to this paragraph for the first willful breach of this Exhibit A or its Riders unless the breaching party has failed to cure after being provided notice and a reasonable opportunity to cure. Penalties may be imposed for subsequent willful breaches by Developer, Consultant, Contractor or Retail Tenant whether or not the breach is subsequently cured. For purposes of this paragraph, "willful breach" means a knowing and intentional breach.

(g) Direct that Developer, Consultants, general contractor, any prime contractors, any Subcontractor, or Retail Tenant to produce and provide to the Agency any records, data or reports which are necessary to determine if a violation has occurred and/or to monitor the performance of Developer, Consultant, prime contractors, any Subcontractor, or Retail Tenant.

9.10 Arbitrator's Decision. The arbitrator shall make his or her award within twenty (20) days of the date that the hearing is completed; provided that where a temporary restraining order is sought, the arbitrator shall make his or her award not later than twenty-four (24) hours after the hearing on the motion. The arbitrator shall send the decision by certified or registered mail to the Agency, Developer and the non-compliant Consultant, prime contractors, Subcontractor, or Retail Tenant, if any.

9.11 Default Award; No Requirement to Seek an Order Compelling Arbitration. The arbitrator may enter a default award against any party (e.g., prime contractor, Subcontractor) who fails to appear at the hearing; provided that said party received actual notice of the hearing. In a proceeding seeking a default award against a party other than Developer, Developer shall provide proof of service on the party as required by Section 9.7. If Developer fails to provide proof of service, Developer shall pay two thousand five hundred dollars (\$2,500.00), as liquidated damages, to the Agency; provided that, no such damages shall be assessed if Developer demonstrates that it made Good Faith Efforts to serve the party. In order to obtain a default award, the complaining party need not first seek or obtain an order to arbitrate the controversy pursuant to Code of Civil Procedure § 1281.2.

9.12 Arbitrator Lacks Power to Modify. Except as otherwise provided (e.g., Section 5.6(b) of Rider 3), the arbitrator shall have no power to add to, subtract from, disregard, modify or otherwise alter the terms of the Agreement, this Exhibit A, the Riders incorporated herein or any other agreement between the Agency and Developer, or to negotiate new agreements or provisions between the parties.

9.13 Jurisdiction/Entry of Judgment. The inquiry of the arbitrator shall be restricted to the particular controversy which gave rise to the Request for Arbitration. A decision of the arbitrator issued hereunder shall be final and binding upon the Agency, Developer, non-compliant Consultants, prime contractors, Subcontractors and Retail Tenants, if any, sent by mail to the Agency, Developer and the non-compliant Consultant, prime contractors, Subcontractor, or Retail Tenant, if any. The losing party shall pay the arbitrator's fees and related costs of arbitration. If a Consultant, prime contractor or Subcontractor is the losing party and fails to pay said fees within thirty (30) days of the decision, Developer shall pay the fees. Each party shall pay its own attorneys' fees provided that fees may be awarded to the prevailing party if the arbitrator finds that the Request for Arbitration was frivolous or that the arbitration action was otherwise instituted or litigated in bad faith. Judgment upon the arbitrator's decision may be entered in any court of competent jurisdiction.

9.14 Delays Due to Enforcement. In the event that Developer does not timely perform its obligations under the Agreement because of an arbitrator's order against a party other than Developer, the time for any performance by Developer shall be extended for a period commensurate with the period of said cessation of work; provided that, Developer shall take all actions reasonably necessary to minimize any delays.

9.15 Exculpatory Clause. Developer, Consultants, general contractor, prime contractors, Subcontractors (regardless of tier), and Retail Tenants of Developer expressly waive any and all claims against the Agency for damages, direct or indirect, including, without limitation, claims relative to the commencement, continuance and completion of construction. Developer, Consultants, prime contractors, all Subcontractors (regardless of tier), and Retail Tenants acknowledge and agree that the procedures set forth herein for dealing with alleged breaches or failure to comply with the obligations and requirements of this Exhibit A and the equal opportunity obligations of the Agreement are reasonable and have been anticipated by the parties in securing financing, in inviting, submitting and receiving bids for the planning, design and construction of the Horizontal Improvements upon the Project Site and Agency Parcels, and in determining the times for commencement and completion of the planning, design and construction or related work.

9.16 California Law Applies. California law, including the California Arbitration Act, Code of Civil Procedure §§ 1280 through 1294.2, shall govern all arbitration proceedings.

9.17 Additional Arbitration Provisions in Riders. The arbitration provisions contained in this Exhibit A are subject to the specific arbitration provisions, if any, set forth in Riders 1 through 3.

9.18 Designation of Agent for Service. Not later than five (5) days after the execution of the Agreement, Developer shall designate a person or business, residing or located

in the City and County of San Francisco, as its agent for service of a Request for Arbitration and all notices provided for herein. If Developer has an office located in San Francisco, it may designate itself as agent for service. The designation shall be served on the Agency and shall include the address of the agent.

9.19 NOTICE: BY INITIALING IN THE SPACE BELOW YOU ARE AGREEING TO HAVE ANY DISPUTE ARISING OUT OF THE MATTERS INCLUDED IN THE "ARBITRATION OF DISPUTES" PROVISION DECIDED BY NEUTRAL ARBITRATION AS PROVIDED BY CALIFORNIA LAW AND YOU ARE GIVING UP ANY RIGHTS YOU MIGHT POSSESS TO HAVE THE DISPUTE LITIGATED IN COURT OR JURY TRIAL. BY INITIALING IN THE SPACE BELOW YOU ARE GIVING UP YOUR JUDICIAL RIGHTS TO DISCOVERY AND APPEAL, UNLESS SUCH RIGHTS ARE SPECIFICALLY INCLUDED IN THE "ARBITRATION OF DISPUTES" PROVISION. IF YOU REFUSE TO SUBMIT TO ARBITRATION AFTER AGREEING TO THIS PROVISION, YOU MAY BE COMPELLED TO ARBITRATE UNDER THE AUTHORITY OF THE CALIFORNIA CODE OF CIVIL PROCEDURE. YOUR AGREEMENT TO THIS ARBITRATION PROVISION IS VOLUNTARY.

WE HAVE READ AND UNDERSTAND THE FOREGOING AND AGREE TO SUBMIT DISPUTES ARISING OUT OF THE MATTERS INCLUDED IN THE "ARBITRATION OF DISPUTES" PROVISION TO NEUTRAL ARBITRATION.



Agency



Developer

Section 10. Condition Precedent.

10.1 If the Agency determines that Developer, its Consultants, general contractor or any prime contractor is in breach of this Exhibit A or any of its Riders, the Agency may require, as a condition precedent to the Agency's obligation to convey the Project Site, that Developer cure the alleged breach.

10.2 If Developer disagrees with the Agency's determination that it is in breach, Developer, as its exclusive remedy, may take the dispute to arbitration pursuant to Section 9 of this Exhibit A.

Section 11. Severability. The provisions of this Exhibit A and each Rider incorporated herein are declared to be separate and severable. The invalidity of any clause, sentence, paragraph, subdivision, section or portion of this Exhibit A or any Rider, or the invalidity of the application thereof to any person or circumstance shall not affect the validity of the remainder of this Exhibit A and/or Rider(s), or the validity of their application to other persons or circumstances.

RIDER 1

CONSTRUCTION WORK FORCE

Section 1. Purpose. The purpose of the Agency and Developer entering into this Rider 1 is to ensure equal employment opportunities for Minority Group Persons and women in the construction work force involved in building the Horizontal Improvements upon the Project Site and Agency Parcels covered by the Agreement. To achieve this purpose, the Agency and Developer adopt the standards and requirements set forth below, which are modeled on the standards and requirements of Executive Order 11246 and its implementing regulations including those contained in 41 Code of Federal Regulations (“CFR”) 60-1.4, 60-4.2 and 60-4.3.

Section 2. Work Force Goals.

2.1 The goals set forth below are expressed as a percentage of each Contractor's total hours of employment and training by trade on the Project Site and Agency Parcels. The goals represent the level of Minority and female utilization each Contractor should reasonably be able to achieve in each construction trade in which it has employees on the Project Site and Agency Parcels. Developer agrees, and will require each Contractor (regardless of tier), to use its Good Faith Efforts to employ Minority Group Persons and women to perform construction work upon the Horizontal Improvements at the Project Site and Agency Parcels at a level at least consistent with said goals.

2.2 Goals.

(a) Goal for Minority group participation in each trade: *twenty-five and six tenths percent (25.6%)* (current Office of Federal Contract Compliance Programs, hereinafter “OFCCP,” goal) of the total hours worked in the trade.

(b) Goal for female participation in each trade: *six and nine tenths percent (6.9%)* (current OFCCP goal) of the total hours worked in the trade.

(c) Goal for participation of San Francisco residents in each trade: *fifty percent (50%)* of the total hours worked in the trade. Residents of the BVHP Area shall be given First Consideration for Employment followed by other San Francisco residents.

2.3 If a conflict arises, achieving the ethnic and gender goals shall take precedence over achieving the residency goal set forth in Section 2.2(c).

2.4 The goals set forth in Section 2.2 shall be amended to reflect either:

(a) **New goals issued by the Director of OFCCP.** The Director of OFCCP shall issue new goals pursuant to 41 C.F.R. 60-4.6 as published periodically in the Federal Register in notice form; or

(b) **New goals issued by the Agency.** Goals issued by the Agency shall either reflect the availability of Minority Group Persons and/or women in the relevant labor

area to perform construction work generally or by trade, or be designed to correct the effects of past discrimination in situations where the Agency concludes that the facts establish a prima facie case of discrimination against a Minority group or women, or otherwise meet the current judicial standards for setting employment goals. A judicial finding of discrimination shall not be a prerequisite to the establishment of new goals by the Agency. If Developer believes that the new goals violate applicable legal standards, Developer may challenge the goals either through arbitration under Exhibit A to Attachment 24 or in a de novo court action. If Developer does mount such a challenge, the Agency, among its other legal and equitable remedies, may require that work be suspended until the challenge is resolved.

2.5 Amendments to the goals shall be prospective and go into effect twenty (20) days after the Agency mails written notice of the amendments to Developer. New goals shall not be applied retroactively.

2.6 Although Section 2.2 establishes a single goal for Minority Group Persons and a separate, single goal for women, each Contractor is required to provide equal employment opportunity and to take equal opportunity for all ethnic groups, both male and female, and all women, both Minority and non-Minority. Consequently, a Contractor may be in violation of this Rider if a particular ethnic group is employed in a substantially disparate manner (for example, even though the Contractor has achieved its goal for women generally, the Contractor may be in violation if a specific ethnic group of women is underutilized.) If the Agency determines, after affording a Contractor notice and an opportunity to be heard, that the Contractor has violated its obligations under this paragraph, the Agency may set, for that Contractor, work force participation goals by a particular ethnic group, *e.g.*, Blacks, Latinos, etc.

2.7 Each Contractor is individually required to comply with its obligations under this Rider 1, and to make a Good Faith Effort to achieve each goal in each trade in which it has employees employed at the Project Site and Agency Parcels. (See Section 4 below.) The overall good faith performance by other Contractors or Subcontractors toward a goal does not excuse any covered Contractor's failure to make Good Faith Efforts to achieve the goals.

2.8 The Contractor shall not use the goals or equal opportunity standards to discriminate against any person because of age, ancestry, color, creed, disability, gender, national origin, race, religion or sexual orientation.

2.9 In order for the non-working training hours of apprentices and trainees to be counted in meeting the goals, such apprentices and trainees must be employed by the Contractor during the training period, and the Contractor must have made a commitment to employ the apprentices and trainees at the completion of their training, subject to the availability of employment opportunities. Unless otherwise permitted by law, trainees must be trained pursuant to training programs approved by the U.S. Department of Labor, Employment and Training Administration, Bureau of Apprenticeship and Training ("BAT") or the California Department of Industrial Relations, Division of Apprenticeship Standards ("DAS").

Section 3. Incorporation. Whenever Developer, the general contractor, any prime contractor, or any Subcontractor (regardless of tier) subcontracts a portion of the work on the

Project Site and Agency Parcels involving any construction trade, it shall set forth verbatim and make binding on each Subcontractor which has a contract in excess of ten thousand dollars (\$10,000.00) the provisions of Exhibit A to Attachment 24 of the Agreement and this Rider 1, including the applicable goals for Minority group and female participation in each trade. Developer, the general contractor, any prime contractor, or any Subcontractor subject to this provision will submit to the Agency a specific workforce inclusion plan showing a confirmed partnering relationship with a local CBO training provider.

Section 4. Equal Opportunity Requirements.

4.1 Each Contractor shall take specific steps to ensure equal employment opportunity ("EEO"). The evaluation of the Contractor's compliance with this Rider 1 shall be based upon its Good Faith Efforts to achieve maximum results from its actions. Each Contractor shall document these efforts fully, and shall implement equal opportunity steps at least as extensive as the following:

(a) Ensure and maintain a working environment free of harassment, intimidation, and coercion at the Project Site and Agency Parcels. The Contractor shall specifically ensure that all foremen, superintendents, and other on-site supervisory personnel are aware of and carry out the Contractor's obligation to maintain such a working environment with specific attention given to Minority Group Persons or women working at the Project Site and Agency Parcels.

(b) Provide written notification to Young Community Developers, Inc. and/or any other organizations identified for the Contractor by the Agency when the Contractor or its unions have employment opportunities available, and maintain a record of the organizations' responses.

(c) Maintain a current file of the names, addresses and telephone numbers of each off-the-street, Minority group, female or resident applicant and each Minority, female and resident referral from a union, a recruitment source or community organization and of what action was taken with respect to each such individual. If such individual was sent to the union hiring hall for referral and was not referred back to the Contractor by the union, or if referred, not employed by the Contractor, this shall be documented in the file with the reason therefor, along with whatever additional actions the Contractor may have taken.

(d) Provide immediate written notification to the Agency when the union or unions with which the Contractor has a collective bargaining agreement has not referred to the Contractor a Minority Group Person, a woman or a resident sent or requested by the Contractor, or when the Contractor has other information that the union referral process has impeded the Contractor's efforts to meet its obligations. In this connection, Developer shall also work with the unions to develop an apprentice and pre-apprentice program for skilled trades for a specified minimum of residents. This program will be incorporated in any Project Labor Agreement and in applicable construction contracts.

(e) Develop on-the-job training opportunities and/or participate in training

programs which expressly include Minority Group Persons and women, including apprenticeship, trainee and upgrading programs relevant to the Contractor's employment needs, especially those funded or approved by BAT or DAS. The Contractor shall provide notice of these programs to the sources compiled under Section 4.1(b) above. In this connection, Developer shall provide training space at the Shipyard, and use its vendor relationships to secure heavy equipment, for these training programs.

(f) Disseminate the Contractor's EEO policy by providing notice of the policy to unions and training programs and requesting their cooperation in assisting the Contractor in meeting its EEO obligations; by including it in any policy manual and collective bargaining agreement; by publicizing it in the company newspaper, annual report, etc.; by specific review of the policy with all management personnel and with all Minority group and female employees at least once a year; and by posting the company EEO policy on bulletin boards accessible to all employees at the Project Site and Agency Parcels.

(g) Review, prior to beginning work at the Project Site and Agency Parcels and at least annually thereafter, the Contractor's EEO policy and equal opportunity obligations under the Agreement and this Rider 1 with all employees having any responsibility for hiring, assignment, layoff, termination or other employment decisions including specific review of these items with on-site supervisory personnel such as superintendents, general foremen, etc. A written record shall be made and maintained identifying the time and place of these meetings, persons attending, subject matter discussed and disposition of the subject matter. The Agency's contract compliance staff shall be invited to attend the meeting held prior to the beginning of work at the Project Site and Agency Parcels.

(h) Disseminate the Contractor's EEO policy externally by including it in any advertising in the news media, specifically including Minority and female news media, and providing written notification to and discussing the Contractor's EEO policy with other Contractors and Subcontractors with whom the Contractor does or anticipates doing business.

(i) Direct its recruitment efforts, both oral and written, to local Minority group, female and community organizations, to schools with Minority and female students and to Minority and female recruitment and training organizations serving the Contractor's recruitment area and employment needs. Not later than one (1) month prior to the date for the acceptance of applications for apprenticeship or other training by any recruitment source, the Contractor shall send written notification to organizations such as the above, describing the openings, screening procedures, and tests to be used in the selection process.

(j) Encourage present Minority and female employees to recruit other Minority Group Persons and women and, where reasonable, provide after school, summer and vacation employment to Minority and female youth both on the Project Site and Agency Parcels and in other areas of a Contractor's work force.

(k) Validate all tests and other selection requirements where there is an obligation to do so under 41 C.F.R. Part 60-3.

(l) Conduct, at least annually, an inventory and evaluation of Minority and female personnel for promotional opportunities and encourage these employees to seek or to prepare for, through appropriate training etc., such opportunities.

(m) Ensure that seniority practices, job classifications, work assignments and other personnel practices do not have a discriminatory effect by continually monitoring all personnel and employment related activities to ensure that the EEO policy and the Contractor's obligations hereunder are being carried out.

(n) Ensure that all facilities and company activities are nonsegregated except that separate or single-user toilet and necessary changing facilities shall be provided to assure privacy between the genders.

(o) Conduct a review, at least annually, of all supervisors' adherence to and performance under the Contractor's EEO policies and equal opportunity obligations.

4.2 Contractors are encouraged to participate in voluntary associations that assist in fulfilling one or more of their equal opportunity obligations under Section 4.1(a) through (o). The efforts of a contractor association, joint contractor-union, contractor-community, or other similar group of which the Contractor is a member and participant, may be asserted as fulfilling any one or more of its obligations under Section 4.1(a) through (o) provided that the Contractor actively participates in the group, makes every effort to assure that the group has a positive impact on the employment of Minority Group Persons and women in the industry, ensures that the concrete benefits of the program are reflected in the Contractor's Minority and female work force composition, makes Good Faith Efforts to meet its individual goals, and can provide access to documentation which demonstrates the effectiveness of actions taken on behalf of the Contractor. The obligation to comply, however, is the Contractor's and failure of such a group to fulfill an obligation shall not be a defense for the Contractor's non-compliance.

Section 5. Additional Provisions.

5.1 The failure by a union with which the Contractor has a collective bargaining agreement, to refer either Minority Group Persons or women shall not excuse the Contractor's obligations under this Rider 1.

5.2 A Contractor shall not enter into any subcontract with any person or firm that the Contractor knows or should have known is debarred from government contracts pursuant to Executive Order 11246.

5.3 No employee to whom the equal opportunity provisions of this Rider 1 are applicable shall be discharged or in any other manner discriminated against by the Contractor because such employee has filed any complaint or instituted or caused to be instituted any proceeding under or relating to Exhibit A to Attachment 24 of the Agreement or this Rider.

5.4 Each Contractor shall designate a responsible official to monitor all employment-related activity to ensure that the Contractor's EEO policy is being carried out.

Section 6. Documentation and Records.

6.1 Submission of Certified Payrolls to the Agency. Each Contractor shall submit through the general contractor to the Agency by noon on each Wednesday a report providing the information contained in the Agency's Optional Form of payroll report for the week preceding the previous week on each of its employees. Each prime contractor is responsible for the submission of this report by each of its Subcontractors.

6.2 Instructions for Coding Certified Payrolls. In addition to maintaining the information required by Section 6.3, each Contractor shall include, on the weekly payroll submissions, the code designating each employee's craft, skill level, protected class status and domicile in accordance with the following table:

Table for Coding Crafts, Minority Group Persons, Women and Residents on Certified Payrolls

CRAFT CODE	DESCRIPTION	CRAFT CODE	DESCRIPTION
1	Electrician	22	Carpet, Linoleum, Vinyl Tile Layer
2	Iron Worker	23	Elevator Constructor
3	Sheet Metal Worker	24	Cement Mason
4	Asbestos Wrkr/Heat & Frost Insulator	25	Laborer or Allied Worker
5	Plumber, Pipe or Steamfitter	26	Glazier & Glassmaker
6	Refrigeration	27	Painter, Paperhanger, Taper
7	Boilermaker	28	Sign Installer
8	Sprinkler Fitter	29	Scrapper
9	Brick, Caulk, Marble, Point, Terrazzo	30	Awning Installer
10	Hod Carrier	31	Drapery Hanger
11	Terrazzo Finisher	32	Low Voltage Electrician
12	Plasterer	33	Towboat Operator-Marine Engineer
13	Lather	34	Towboat Deckhand-Inland Boatworker
14	Carpenter or Drywall Hanger	35	Owner/Operator - Truck
15	Mill Worker or Cabinetmaker	36	Owner/Operator - Heavy Equipment
16	Millwright	37	Upholsterer
17	Roofer	38	Teamster, Construction
18	Pile Driver	39	Janitor
19	Surveyor/Operating Engineer	40	Environmental Control System Installer
20	Tile (Ceramic)/Marble Finisher	41	Window Cleaner
21	Tile (Ceramic)Setter	89	Security Guard

CODE	DESCRIPTION	CODE	DESCRIPTION
D	San Francisco-Domiciled	B	Black
R	BVHP Area-Resident	I	American Indian
L	Latino	C	Caucasian/White
A	Asian/Pacific Islander	W	Woman

6.3 Required records. For each employee, the Contractor's payroll or similar record shall contain the name, address, whether an employee lives in the BVHP Area, telephone numbers, construction trade, classification, union affiliation (if any), employee identification number, Social Security number, gender, race, status (e.g., mechanic, apprentice, trainee, helper or laborer), dates of changes in status, hourly wage rates (including rates of contributions for costs anticipated for fringe benefits or cash equivalents thereof), daily and weekly number of hours worked, deductions made and actual wages paid. Records shall be maintained in an easily understandable and retrievable form; provided that, to the extent that existing records satisfy this requirement, the Contractor shall not be required to maintain separate records.

6.4 Additional Information. The report required by Section 6.2 shall be accompanied by:

(a) A statement of any problems encountered by the Contractor in obtaining Minority, female or resident referrals from any union; and

(b) A statement of the reasons the Contractor failed to meet the ethnic and gender employment goals (if the goals were not met), the reasons the Contractor failed to meet the fifty percent (50%) San Francisco residency goal (if that goal was not met) and the reasons the Contractor was not able to perform any of the equal opportunity steps set forth in Section 4.1(a) through (o) (if any of the steps were not taken).

6.5 Inspection of Records. The Contractor shall make the records required under this Section available for inspection or copying by authorized representatives of the Agency, and shall permit such representatives to interview employees during working hours on the job.

6.6 Failure to Submit Reports. If a Contractor fails or refuses to provide the reports to the general contractor as required by Section 6.1, the Agency, upon notice from the general contractor or Developer, shall consider but not be required to institute arbitration proceedings against the non-compliant Contractor.

6.7 Submission of Good Faith Effort Documentation. If the Contractor's Good Faith Efforts are at issue, the Contractor shall provide the Agency with the documentation of its efforts as required by Section 4.1.

Section 7. Arbitration of Disputes. The Agency, Developer and any affected Contractor may take any dispute concerning the interpretation, implementation or alleged breach of this Rider to arbitration in accordance with the arbitration provisions of Exhibit A to Attachment 24 of the Agreement.

Section 8. Preconstruction Workforce Inclusion Meeting.

8.1 Prior to Close of Escrow and Commencement of Construction, the general contractor, any prime contractor, or any Subcontractor (regardless of tier) shall attend a preconstruction meeting convened by the Agency and to which outreach organizations are invited to review the reporting requirements, the prospective work force composition and any problems that may be anticipated in meeting the work force goals. This will be the only agenda for this meeting, which is intended to be separate from the bid conference or any other preconstruction meeting. The Contractor's and Subcontractors' personnel attending this meeting will include their respective intended project managers and foreman.

8.2 Any Subcontractor (regardless of tier), who does not attend such a meeting shall not be permitted on the job site. The Agency shall convene additional preconstruction workforce inclusion meetings within twenty-four (24) hours of the Contractor's request. The Contractor shall endeavor to include as many prospective Subcontractors as possible at these meetings in order not to protract unduly the number of meetings.

8.3 Failure to comply with this preconstruction workforce inclusion meeting provision shall result in the Agency ordering a suspension of work by the prime contractor and/or the Subcontractor until the breach has been cured. Suspension under this provision is not subject to arbitration.

Section 9. Term. The obligations of Developer and the Contractors with respect to their construction work forces, as set forth in Exhibit A to Attachment 24 of this Agreement and this Rider 1, shall remain in effect until completion of all work to be performed by Developer in connection with the initial construction Horizontal Improvements at the Project Site and Agency Parcels.

RIDER 2

EQUAL OPPORTUNITY FOR MINORITY AND WOMAN-OWNED BUSINESS ENTERPRISES

Section 1. Purpose. The purpose of the Agency and Developer in entering into this Rider 2 is to establish a set of MBE and WBE participation goals and Good Faith Efforts designed to ensure that monies are spent in a manner which is nondiscriminatory and which provides MBEs and WBEs with an equal opportunity to compete for and participate in contracts for the planning, design and construction of the Horizontal Improvements upon the Project Site and Agency Parcels covered by the Agreement.

Section 2. Incorporation. Each Contract between Developer, a Consultant, the general contractor, a prime contractor or a Subcontractor (regardless of tier) and any person shall physically incorporate and make binding on the parties to that Contract Sections 1, 2, 3, 9 and 10 of Exhibit A to Attachment 24 and this Rider 2.

Section 3. MBE and WBE Participation Goals.

The Agency has made a finding that discrimination has occurred against businesses owned by women and Minority Group Persons. Accordingly, each Contractor shall make Good Faith Efforts to achieve the goals which have been designed to correct the effects of past discrimination and are set forth in Exhibit A to Attachment 24.

Section 4. Good Faith Efforts to Meet Goals With Local MBEs and WBEs.

4.1 Developer and all Contractors with contracts in excess of ten thousand dollars (\$10,000.00) shall make Good Faith Efforts, described below in Section 4.2, to ensure that M/WBEs have an equal opportunity to compete for and participate in contracts for the planning, design and construction of the Horizontal Improvements upon the Project Site and Agency Parcels. A genuine effort will be made to consider local M/WBEs before looking outside of San Francisco. This obligation covers all contracts involved in the Horizontal Improvements upon the Project Site and Agency Parcels, including professional service contracts, consultant contracts and contracts and subcontracts for labor, materials, supplies and trucking. The general contractor and prime contractors are responsible for ensuring that each of their Subcontractors meets these requirements.

4.2 A Contractor's compliance with the following steps will be the basis for determining if the Contractor has made Good Faith Efforts to meet the goals for MBEs and WBEs. A Contractor's failure to make Good Faith Efforts will result in financial penalties in the same fashion as set forth in Rider 4, the First Source Hiring Program:

(a) Not less than thirty (30) days prior to the opening of bids or the selection of Contractors, Developer or Contractor shall:

(1) advertise for M/WBEs interested in competing for the contract, in

general circulation media, trade association publications, including timely use of the *Bid and Contract Opportunities* newsletter published by the City and County of San Francisco Purchasing Department and media focused specifically on M/WBEs such as the *Small Business Exchange*, of the opportunity to submit bids or proposals and to attend a pre-bid meeting to learn about contracting opportunities.

(2) search through available published lists of M/WBEs in the Bay Area which provide the service being sought including such Agency directories as *Minority-owned Construction Contractors and Truckers* and *Woman-owned Construction Contractors and Truckers*, in order to identify such M/WBEs and provide written notice to them, of the opportunity to bid for contracts and to attend a pre-bid or pre-solicitation meeting to learn about contracting opportunities.

(b) Hold a pre-bid meeting for all interested Contractors not less than fifteen (15) days prior to the opening of bids or the selection of Contractors. The Agency shall be invited to attend as an observer.

(c) Developer or Contractor shall follow up initial solicitations of interest by contacting the M/WBEs to determine with certainty whether the enterprises are interested in performing specific items involved in work on the Project Site and Agency Parcels.

(d) Developer and the Contractor shall divide, to the greatest extent feasible, the contract work into small units to facilitate M/WBE participation, including, where feasible, offering items of the contract work which the Contractor would normally perform itself.

(e) Developer and the Contractor shall provide M/WBEs with complete, adequate and ongoing information about the plans, specifications and requirements of construction work, service work and material supply work. This Section 4.2(e) does not require Developer or Contractor to give M/WBEs any information not provided to other Contractors. This Section 4.2(e) does require Developer and the Contractor to answer carefully and completely all reasonable questions asked by M/WBEs and to undertake every Good Faith Effort to ensure that M/WBEs understand the nature and the scope of the work.

(f) Developer and the Contractor, where feasible, shall negotiate with M/WBEs in good faith and demonstrate that M/WBEs were not rejected as unqualified without sound reasons based on a thorough investigation of their capacities.

(g) Developer and the Contractor shall prohibit the shopping of the bids. Where Developer or Contractor learns that bid shopping has occurred, it shall treat such bid shopping as a material breach of contract.

(h) Developer or Contractor shall assist M/WBEs in their efforts to obtain bonds, lines of credit and insurance. Developer and the Contractor shall require no more stringent bond or insurance standards of M/WBEs than required of other business

enterprises.

(i) Developer and the Contractor shall establish delivery schedules, which encourage participation of M/WBEs.

(j) Developer and its general contractor shall encourage and assist higher tier Subcontractors in undertaking Good Faith Efforts to utilize M/WBEs as lower tier Subcontractors.

(k) Developer and the Contractor shall use the services of Minority and woman contractor associations, federal, state and local M/WBE assistance offices and other organizations that provide assistance in the recruitment and placement of M/WBEs, including the Small Business Administration and the Minority Business Development Agency of the Department of Commerce.

Section 5. Procedures.

5.1 Notice to Agency. Developer or Contractor shall provide the Agency with the following information within ten (10) days of awarding a contract or selecting a Subcontractor:

- (a) the nature of the contract, *e.g.*, type and scope of work to be performed;
- (b) the dollar amount of the contract; and
- (c) the name, address, license number, gender and ethnicity of the person to whom the contract was awarded.

5.2 Affidavit. If Developer or Contractor contend that the contract has been awarded to an MBE or WBE, Developer or Contractor shall, at the same time also submit to the Agency an M/WBE Application for Certification and its accompanying Affidavit (Attachment A hereto) completed by the Minority or woman owner; provided that an M/WBE that was previously recognized by the Agency may, instead, submit only the short M/WBE Eligibility Statement (Attachment B hereto).

5.3 Good Faith Documentation. If the contract is not awarded to an MBE or WBE, Developer or Contractor shall meet and confer with the Agency at a date and time set by the Agency. If the issue of Developer or Contractor's Good Faith Efforts is not resolved at this meeting, Developer or Contractor shall submit to the Agency within five (5) days, a declaration under penalty of perjury containing the following documentation with respect to the Good Faith Efforts:

(a) A report showing the responses, rejections, proposals and bids (including the amount of the bid) received from M/WBEs, including the date each response, proposal or bid was received. This report shall indicate the action taken by Developer or Contractor in response to each proposal or bid received from M/WBEs, including the reasons(s) for any rejections.

(b) A report showing the date that the bid was received, the amount bid by and

the amount to be paid (if different) to the non-M/WBE Contractor that was selected. If the non-M/WBE Contractor who was selected submitted more than one bid, the amount of each bid and the date that each bid was received shall be shown in the report. If the bidder asserts that there were reasons other than the respective amounts bid for not awarding the contract to an M/WBE, the report shall also contain an explanation of these reasons.

(c) Documentation of advertising for and contacts with M/WBEs, Minority or female contractor associations or development centers, or any other agency which disseminates bid and contract information to M/WBEs.

(d) Copies of initial and follow-up correspondence with M/WBEs, Minority or female contractor associations and other agencies that assist M/WBEs.

(e) A description of the assistance provided Minority and woman-owned firms relative to obtaining and explaining plans, specifications and contract requirements.

(f) A description of the assistance provided to M/WBEs with respect to bonding, lines of credit, etc.

(g) A description of efforts to negotiate or a statement of the reasons for not negotiating with M/WBEs.

(h) A description of any divisions of work undertaken to facilitate M/WBE participation.

(i) Documentation of efforts undertaken to encourage Subcontractors to obtain M/WBE participation at a lower tier.

(j) A report which shows for each private project and each public project (without an M/WBE program) undertaken by the bidder in the preceding twelve (12) months, the total dollar amount of the contract and the percentage of the contract dollars awarded to MBEs and the percentage of contract dollars awarded to WBEs.

(k) Documentation of any other efforts undertaken to encourage participation by M/WBEs.

5.4 Waiver of Submissions. The Agency may waive any of the submission requirements set forth in Section 5.3(a) through (k) if the Agency determines that a specific requirement is not relevant to the particular situation at issue, that M/WBEs were not available, or that M/WBEs were attempting to exploit the program by charging an unreasonable price.

5.5 Presumption of Good Faith Efforts. If the Contractor achieves the Participation Goals, it will not be required to submit Good Faith Effort documentation.

5.6 M/WBE Determination. Where Developer or Contractor makes a submission pursuant to Section 5.2, the Agency shall make a determination, pursuant to the criteria set forth below in Section 6.2 of this Rider 2 as to whether or not an enterprise which Developer or

Contractor claims is Minority or woman-owned is in fact owned and controlled by Minority Group Persons or women. If the Agency determines that the enterprise is not an MBE or a WBE, the Agency shall give Developer or the Contractor a "Notice of Non-Qualification" and provide Developer or the Contractor with a reasonable period (not to exceed twenty (20) days) in which to meet with the Agency and if necessary make a submission, in accordance with Section 5.3, concerning its Good Faith Efforts. If Developer or Contractor disagrees with the Agency's Notice of Non-Qualification, Developer or Contractor may request arbitration pursuant to Section 7 of this Rider 2.

5.7 Where Developer or Contractor makes a submission pursuant to Section 5.3 and, as a result, the Agency has cause to believe that Developer or the Contractor has failed to undertake Good Faith Efforts, the Agency shall conduct an investigation. After affording Developer or the Contractor notice and an opportunity to be heard, the Agency shall recommend such remedies and sanctions as it deems necessary to correct any alleged violation(s). The Agency may recommend only the remedies and sanctions set forth in Section 9 of Exhibit A to Attachment 24 of the Agreement. The Agency shall give Developer and the Contractor a written "Notice of Non-Compliance" setting forth its findings and recommendations. If Developer and the Contractor disagree with the findings and recommendations of the Agency as set forth in the Notice of Non-Compliance, Developer and the Contractor may request arbitration pursuant to Section 7 of this Rider 2.

Section 6. Criteria for Determining M/WBE Eligibility.

6.1 Agency's Role. The Agency shall exercise its reasonable judgment in determining whether a firm whose name is submitted by Developer or Contractor as an MBE or WBE is owned and controlled by Minority Group Persons and/or women. A firm's appearance in any of the Agency's current directories of Minority or Woman-Owned Construction Contractors and Truckers will be considered by the Agency as prima facie evidence that the firm is an MBE or a WBE.

6.2 M/WBE Certification Criteria.

(a) The Agency will accept the certifications or denials of the Human Rights Commission of the City and County of San Francisco unless the Agency has reasonable grounds to believe that the certification or denial is inappropriate or otherwise incorrect.

(b) In order to be certified as an MBE, WBE or W/MBE the business must meet the definition of MBE, WBE or W/MBE set forth in Section 2 of Exhibit A to Attachment 24.

(c) In order for the M/WBE component of a joint venture to be recognized, the ownership interest must meet a thirty-five percent (35%) threshold; provided that, if the joint venture subcontracts to non-M/WBEs a percent of the work in excess of the percentage interest that the M/WBE has in the joint venture, the joint venture shall not be recognized as an M/WBE.

(d) The Agency will not recognize a Subcontractor as an M/WBE if it subcontracts more than fifty percent (50%) of its subcontract amount to non-M/WBEs.

(e) A Contractor may substitute the amount of a purchase order to a Minority or woman-owned supplier for up to fifteen percent (15%) of the M/WBE Subcontractor goals. The Agency will not recognize a supplier as an M/WBE if it is acting solely as a conduit or manufacturer's representative. In order to be recognized, a supplier must perform a commercially useful function in the supply process. However, if the supplier is acting as a mere conduit, such as a manufacturer's representative or broker, then only the amount of the commission or three percent (3%), whichever is greater, will be credited towards meeting the M/WBE goals. If none of the work is to be subcontracted, Minority and woman-owned suppliers may be counted without limitation.

(f) An eligible MBE or WBE shall be an independent business. In determining whether a business is independent, the Agency shall examine the adequacy of the business' resources for the scope of work under a proposed contract, its financial independence, the extent of its equipment leasing and its relationships with non-Minority firms, and whether the firm:

(1) is known in the industry or trade to be operated by a non-Minority male;

(2) is operated in tandem with a non-M/WBE;

(3) has multiple licenses, some of which belong to non-M/WBEs;

(4) itself owns the equipment or trucks that are to be used on the job;

(5) is listed in the telephone book, preferably in the Yellow Pages under the class for which it is seeking Agency recognition;

(6) subcontracts back to, leases from or is back-contracted by its prime contractor or Subcontractor or joint venturer(s) in an amount unrelated to shared risks and profits. Back contracting includes any agreement or other arrangement between a prime contractor and its Subcontractor where the prime contractor performs or secures the performance of the subcontract in such a fashion and/or under such terms and conditions that the prime contractor enjoys the financial benefit of the subcontract. Said agreement or other arrangement includes, but is not limited to, situations where either a Contractor or Subcontractor agrees that any term, condition or obligation imposed upon the Subcontractor by the subcontract shall be performed by or be the responsibility of the prime contractor;

(7) maintains a permanent office separate from that of its sources of vehicles, Subcontractors, the general contractor or from any joint venturer(s); and

(8) in the case of a supplier, carries the material being supplied as a regular part of its inventory.

(g) A Minority or woman-owned firm shall not have any formal or informal

restrictions that limit the customary discretion of the Minority or woman owner. The owner should have the authority to perform all of the below functions:

(1) manage either the marketing or production aspects of the business;

(2) be authorized to sign on all bank accounts, to draw against letters of credit, and to secure surety bonds and insurance; and

(3) control the profit sharing, pensions or stock option plans.

(h) The Minority or woman owner must serve as the Chief Executive Officer of the firm, *i.e.*, be the boss. If there are part-owners of the firm who are not Minority Group Persons or women and who are disproportionately responsible (according to percent or degree of ownership) for the operation of the firm, then the firm shall be deemed not controlled by Minority Group Persons or women and shall not be considered an eligible MBE or WBE. Where the actual day-to-day management of the firm is handled by individuals other than the owner, those persons who have the ultimate power to hire and fire the managers shall be considered as controlling the business. Among the factors considered in making a determination are whether the owner itself:

(1) possesses sufficient working experience and knowledge to perform the contract; and

(2) controls at least fifty-one percent (51%) of the directors' votes if the firm is incorporated.

(i) All securities evidencing full or partial ownership and/or control of a business entity for purposes of establishing it as an MBE or WBE shall be held directly by Minority Group Persons or women.

(j) Minority and woman owners of firms shall make real and substantial contributions of capital and expertise to acquire their interests in the firm. Examples of insufficient contributions include a note payable to the firm or those of its part-owners who are neither Minority Group Persons nor women, or the participation as an employee without management authority.

(k) **License Qualification Essential.** An unregistered person who is used to qualify a professional business as an M/WBE does not meet the Agency's M/WBE requirements of having management and control of the business. Likewise, a person used to qualify a construction business who is not the Qualifying Partner, Responsible Managing Employee or Responsible Managing Officer as these terms are used by the Contractors' State License Board, cannot meet the Agency's M/WBE requirements of having management and control of the business. An owner who is certified by the Agency for one profession, *e.g.*, electrical engineering, cannot attribute that certification to another profession, *e.g.*, mechanical engineering, unless he or she is registered for more than one professional license. By extension a certified Minority-owned plumbing business must also be certified to perform electrical work to be an eligible Minority-owned electrical Contractor.

(l) A business requesting to be certified as an MBE or WBE shall supply the Agency with all such additional information as the Agency may deem relevant in order to make a determination of such status. If such information is not supplied within forty-five (45) days of it being requested, the Agency may consider the Application for certification withdrawn.

(m) A change in ownership of a firm from majority to Minority or woman ownership will be carefully scrutinized. The following factors shall be considered:

(1) The timing of the change in ownership of the business relative to the time that bids are opened or proposals are considered;

(2) Whether an employee-owner who had previous or continuing employee-employer relationship between or among present owners has management responsibilities and capabilities; and

(3) Whether the interest of the non-Minority or non-woman ownership conflicts with the ownership and control requirements of the Agreement.

Section 7. Arbitration of Disputes.

7.1 Subject to Sections 7.2 through 7.4, the Agency, Developer and any affected Contractor may take any dispute concerning the interpretation, implementation or alleged breach of this Rider 2 to arbitration pursuant to the arbitration provisions of Exhibit A to Attachment 24 of the Agreement.

7.2 Where Developer or Contractor disagrees with the Agency's Notice of Non-Qualification or Notice of Non-Compliance, Developer or Contractor shall have seven (7) days, unless otherwise stipulated by the parties, in which to file a Request for Arbitration. If Developer or Contractor fails to file a timely Request for Arbitration, Developer or Contractor shall be deemed to have accepted and to be bound by the finding of Non-Qualification or the findings and recommendations contained in the Notice of Non-Compliance.

7.3 The burden of proof with respect to MBE or WBE status and/or Good Faith Efforts shall be on Developer or Contractor.

7.4 In the case of a dispute over MBE or WBE status, the arbitrator shall make a final decision on the enterprise's status. In all other cases, including disputes over an alleged failure to make Good Faith Efforts, the arbitrator shall have authority to issue relief authorized by Section 9 of Exhibit A to Attachment 24 of the Agreement.

Section 8. Term. The obligations of Developer and the Contractors with respect to M/WBEs, as set forth in Exhibit A to Attachment 24 to the Agreement and this Rider 2, shall remain in effect until completion of all work to be performed by Developer in connection with the original construction of the Project Site and Agency Parcels and any tenant improvements on the Project Site and Agency Parcels performed by or at the request of Developer.

ATTACHMENT A

**APPLICATION FOR CERTIFICATION
(MINORITY OR WOMAN-OWNED BUSINESS ENTERPRISE AFFIDAVIT)
(To be completed by Minority or Woman Owner)**

(Name of Project) (General Contractor if not the General itself)

1. Name of Firm _____
(Has business operated under another name? _____ If so, explain under item 22.)

2. Contact Person _____

3. Business Address _____
(P. O. Box is unacceptable)

4. Mailing Address _____
(If different)

5. Telephone Number(s) _____ FAX: _____

6. Is business address or phone number also that of a residence? _____ If so, please explain under item 22.

7. Indicate the type of industry or the business:

- | | | |
|---------------------------------------|--|-----------------------------------|
| <input type="checkbox"/> Construction | <input type="checkbox"/> Professional Consultant | <input type="checkbox"/> Supplier |
| <input type="checkbox"/> Manufacturer | <input type="checkbox"/> Manufacturer's Representative | <input type="checkbox"/> Other |

Identify types of services or products offered. (Equipment operator or trucker should identify the equipment it owns here or under item 22.)

8. Type of ownership: Corporation Sole Proprietor Partnership
 Joint Venture Indicate if another entity _____

9. With your application please submit true and correct copies of the following documents:
- a. Proof of ethnic identification, such as birth certificate or tribal registration, if you are a Minority owner.
 - b. Contractors' State License No. _____
(Name of person who qualified for license)

NOTE: If you have formed a partnership or incorporated since becoming a contractor, the partnership or corporation must have its own Contractors' State License.

- c. Registration and license issued by the State Board of Architectural Examiners, the Board of Registration for Professional Engineers and Land Surveyors, the State Board of Accountancy or the State Bar of California.
- d. Local business license(s) and permits(s).
- e. Fictitious name filing, if you are doing business as a fictitious entity. The names on the Contractors' State License and the fictitious name filing must match.
- f. Partnership Agreement, if the firm is a partnership. The names of the partners must match those shown to be partners on the Contractors' State License.
- g. If the firm is a corporation:
 - i. Articles of Incorporation,
 - ii. Corporate Bylaws and
 - iii. Minutes of the first meeting.
- h. Joint Venture Agreement (including dollar amount of capital contribution), if a joint venture is the applicant.
- i. Federal personal tax returns, Form 1040, in full with W-2 statements and all supporting schedules and statements for **all** shareholders for the past two (2) years.
- j. Federal corporate tax returns, Form 1120 (including Exhibit E), in full with **all** supporting schedules and statements such as Form 4562 for the past two (2) years.
- k. Resumes pointing out the years of specific experience to qualify for the responsibilities delegated to each **Management** person listed in item fifteen (15) of this Application.
- l. Proof, if the firm is registered as a disadvantaged business under Section 8(a) of the Small Business Act.
- m. Inventory (not to exceed a ten (10)-page extract), if the firm is a manufacturer or supplier.

10. List the owners who have an interest of five percent (5%) or greater:

<u>Name</u>	<u>Ethnicity*</u>	<u>Gender</u> <u>M/F</u>	<u>Date of</u> <u>Ownership</u>	<u>Number</u> <u>of</u> <u>Shares</u>	<u>Vote</u> <u>%</u>	<u>U. S.</u> <u>Citizen</u> <u>(yes/no)</u>
_____	_____	_____	_____	_____	_____	_____
_____	_____	_____	_____	_____	_____	_____
_____	_____	_____	_____	_____	_____	_____
_____	_____	_____	_____	_____	_____	_____

If more Owners, check here and continue listing under item 22.

*American Indian or Alaska Native, which includes Alaska Indians, Inuits and Aleuts (any person having origins in the indigenous peoples of North America and who is an enrolled member of a federally-recognized tribe), Asian (any person of Chinese, Japanese, Korean, Pacific Islander, Samoan, Filipino, Asian-Indian or South East Asian), Black (any person having origins in any of the Black racial groups of Africa), Latino (any person of Spanish culture with origins in Mexico or other Spanish speaking countries in Central or South America, or the Caribbean Islands).

11. List the contributions of money, equipment, real estate, or expertise of each of the owners for firms with less than one hundred percent (100%) disadvantaged ownership.

12. Date firm was established _____. The total number of years the firm has been in business is _____. The number of years the firm has been in business under present ownership is _____. The following is a brief explanation of the change in ownership of the firm (if applicable):

13. Board of Directors:

<u>Name</u>	<u>Title</u>	<u>Ethni- city</u>	<u>Gender M/F</u>	<u>Date Elected/ Expiration/Term</u>
_____	_____	_____	_____	_____
_____	_____	_____	_____	_____
_____	_____	_____	_____	_____
_____	_____	_____	_____	_____

If more Directors, check here and continue listing under item 22.

14. If the Board of Directors has changed within the last three years, list the names of the former Directors, their ethnicity, gender and date of resignation under item 22.

15. **Management:** The following duties are actually performed by the persons indicated below:

a. Preparation of estimates and bids:

by _____ who reports to _____
name name

b. Hiring, firing of management personnel:

by _____ who reports to _____
name name

c. Purchasing of major equipment, material or supplies:

by _____ who reports to _____
name name

d. Financial control:

by _____ who reports to _____
name name

e. Negotiations and approval of contracts:

by _____ who reports to _____
name name

f. Administration of contracts:

by _____ who reports to _____
name name

g. Supervision of field operations:

by _____ who reports to _____
name name

h. Marketing and sales activities:

by _____ who reports to _____
name name

i. Warehouse inventory and control:

by _____ who reports to _____
name name

16. Federal identification no. _____

17. Indicate the firm's gross receipts and average number of employees for the last three tax years:

Year ending _____	Amount _____	Employees _____
_____	_____	_____
Year ending _____	Amount _____	Employees _____
_____	_____	_____
Year ending _____	Amount _____	Employees _____
_____	_____	_____

18. **MANUFACTURERS AND SUPPLIERS ONLY**: For last year:

a. Lowest no. of employees _____

b. Highest no. of employees _____

c. No. of employees whose job lasted the entire year _____

d. Were any of the employees on another firm's payroll? _____ If so, identify the firm: _____

e. Value of current inventory \$ _____

f. Location of inventory _____

19. How were applications to other local agencies handled?

	<u>Name of local agency</u>	<u>L/M/WBE?</u>	<u>Approved Yes/No</u>	<u>Date</u>
a.	_____	_____	_____	_____
b.	_____	_____	_____	_____
c.	_____	_____	_____	_____
d.	_____	_____	_____	_____

20. Name of Surety _____

Name of Agent _____ Telephone No. _____

Bonding Limit _____ Sources of letter of credit _____

21. If the firm or other firms with any of the same officers has previously been denied recognition as an M/WBE, MBE or WBE please explain the circumstances.

22. Identify any owner or management official of the named firm who is or has been an employee of another firm that has an ownership interest in or a present business relationship with the named firm. Describe present business relationships that include sharing space, equipment, financing or employees, as well as common owners. Please use this additional space to supplement the information provided above, especially under items 1, 6, 10, 11, 12 and 13. You may attach additional sheets.

23. The firm intends to subcontract _____ percent of the work to be performed under its contract with _____ to the following:

M/WBE	<u>Name</u>	<u>Amount of</u> <u>Yes/No</u>	<u>Subcontract</u>	<u>Scope of Work</u>
a.	_____	_____	_____	_____
b.	_____	_____	_____	_____
c.	_____	_____	_____	_____
d.	_____	_____	_____	_____

AFFIDAVIT

(To be completed by Minority or Woman Owner)

"The undersigned swears that the foregoing statements are true and correct and include all material information necessary to identify and explain the operations of _____

(Name of Firm)

as well as the ownership thereof. Further, the undersigned covenant(s) and agree(s) to provide to the local agency current, complete and accurate information regarding actual joint venture arrangements and to permit the audit and examination of the books, records and files of the joint venture, or those of each joint venturer relevant to the joint venture, by authorized representatives of the agency. Any material misrepresentation will be grounds for terminating any contract which may be awarded and for initiating action under state law concerning false statements."

NOTE:

- a. The conditions outlined in this affidavit are applicable to any additional information that is required to be provided to authenticate the affiant's firm.
- b. You are required to notify the agency if any significant changes occur that would alter your status as an M/WBE.
- c. Section 94.4 of the California Streets and Highways Code states that a D/M/WBE is subject to a civil penalty of not more than \$5,000 if said firm willfully and knowingly makes a false statement with the intent to defraud this certification.

Name of Firm

Signature

Name and Title

Name of Firm

Signature

Name and Title

Date _____

Date _____

On this ____ day of _____, 20____, before me appeared _____, to me personally known, who, being duly sworn, did execute the foregoing affidavit, and did state that he or she was properly authorized by _____ to execute the affidavit and did so as his or her free act and deed. (Name of Firm)

Notary Public _____ Commission expires _____
(Seal)

Date _____, State of California, County of _____

On this ____ day of _____, 20____, before me appeared _____, to me personally known, who, being duly sworn, did execute the foregoing affidavit, and did state that he or she was properly authorized by _____ to execute the affidavit and did so as his or her free act and deed. (Name of Firm)

Notary Public _____ Commission expires _____
(Seal)

Date _____, State of California, County of _____

ATTACHMENT B

M/WBE ELIGIBILITY STATEMENT

(To be completed by Minority or Woman Owner)

(Name of Project)

(General Contractor if not the General itself)

I, _____, declare:

1. I have carefully reviewed the **Affidavit/Declaration** executed by myself on
_____ on behalf of _____
Date Name of Firm

2. The only changes to said document are:

I have personal knowledge of the foregoing facts and if called as a witness I could and would testify competently thereto. I declare under penalty of perjury that the foregoing is true and correct.

Executed on _____
Date

in _____
Place of Execution

Signature of Declarant

Title

RIDER 3

PERMANENT WORK FORCE OF DEVELOPER AND RETAIL TENANTS

Section 1. Purpose. The purposes of the Agency and Developer in entering into this Rider 3 are to ensure:

1.1 that Minority Group Persons and women are provided equal opportunity for and are not discriminated against in employment in Developer's permanent work force that work on the Project Site covered by the Agreement and in the work forces of Retail Tenants which lease space in the Project Site and Agency Parcels.

1.2 that San Francisco residents obtain *fifty percent (50%)* of the permanent jobs in the work forces of Developer and the Retail Tenants at the Project Site and Agency Parcels.

1.3 that residents of the BVHP Area and then other San Francisco residents are given First Consideration for Employment by Developer and the Retail Tenants for permanent employment at the Project Site and Agency Parcels.

Section 2. Application of This Schedule to Retail Tenants. Developer shall include verbatim in its leases and require the incorporation verbatim in all subleases for retail space in the Project Site the provisions of Sections 1, 2, 3, 4.2, 9 and 11 of Exhibit A to Attachment 24 of the Agreement and this Rider 3. The lease shall make the incorporated provisions binding on and enforceable by the Agency against the Retail Tenant to the same extent as the provisions are binding on and enforceable against Developer; except that:

2.1 Unless agreed otherwise by the Agency, a Retail Tenant with *twenty-six (26) or more* employees shall submit its equal opportunity plan (EOP) through Developer to the Agency not later than ninety (90) days prior to hiring any permanent employees to work on the tenant's premises; rather than pursuant to the requirements set forth in Section 5.2 of this Rider 3.

2.2 A Retail Tenant with twenty-five (25) or fewer employees shall not be required to submit an EOP pursuant to Section 4, but instead shall undertake and document in writing the Good Faith Efforts it made to meet the goals and First Consideration in Employment requirements set forth in Section 3 of this Rider 3. The standards and requirements of Subpart C of Revised Order 4, 41 C.F.R. Part 60-2, shall be applied in determining if such a Retail Tenant has exercised Good Faith Efforts.

2.3 A Retail Tenant with fewer than 25 employees shall submit to the Agency the reports required by Section 7 of this Rider 3 not later than sixty (60) days after it opens for business and annually thereafter.

Section 3. Goals and Objectives.

3.1 Developer and each Retail Tenant shall:

(a) make Good Faith Efforts to achieve in each job category in its permanent

work force at the Project Site and Agency Parcels an ethnic and gender mix which reflects the composition of the civilian work force of the City and County of San Francisco. These goals are not to be perceived as inflexible quotas, but rather as objectives to be pursued by the mobilization of available resources and by Good Faith Efforts to fulfill the respective equal opportunity plans.

(b) make Good Faith Efforts to employ fifty percent (50%) of its work force at the Project Site and Agency Parcels in each job category from residents of the City and County of San Francisco.

(c) as provided in Section 4.2(a) of this Rider 3, give First Consideration for Employment at the Project Site and Agency Parcels to BVHP Area residents and then to other residents of San Francisco.

3.2 The Agency anticipates that it will adopt a program to require developers to promote the employment of public assistance recipients and other low-income San Franciscans in permanent jobs created in development, with First Consideration for Employment at the Project Site and Agency Parcels to be given to residents of the BVHP Area.

3.3 If a conflict arises, achieving the ethnic and gender goals set forth in Section 3.1(a) shall take precedence over the San Francisco residency goal and the requirement to give First Consideration in Employment as set forth in Sections 3.1(b) and (c) respectively.

Section 4. Equal Opportunity Plan.

4.1 Developer and each Retail Tenant with more than twenty-six (26) employees, whether or not it is a federal contractor, shall prepare and adopt an EOP for its permanent work force at the Project Site and Agency Parcels which meets the requirements of Executive Order 11246 and all applicable regulations promulgated pursuant thereto (in effect as of March 1, 1990), including Revised Order No. 4, 41 C.F.R. Part 60-2. The utilization analysis and the goals shall be based on the civilian labor force of the City and County of San Francisco according to the most recent census data. A separate utilization analysis shall be performed and a separate goal shall be set for each ethnic group, *i.e.*, American Indian, Asian/Pacific Islander, Black, Latino, and for women.

4.2 In addition to the elements required under Section 4.1, the EOP shall contain the following:

(a) Detailed procedures for ensuring that BVHP Area residents and then other San Francisco residents who are equally or more qualified than other candidates obtain First Consideration for Employment. These procedures shall include specific recruiting, screening and hiring procedures (*e.g.*, phased hiring) which ensure that qualified residents (of the BVHP Area and then other San Franciscans) receive offers of employment prior to other equally or less qualified candidates. If a candidate(s) who is entitled to First Consideration is not selected for the position, Developer or Retail Tenant shall have the burden of establishing to the Agency and the arbitrator (if the matter is taken to arbitration), that the candidate who was selected was better qualified for the position than the candidate(s) who was entitled to First Consideration.

(b) Where it is a reasonable expectation that ten percent (10%) or more of the employees in any job category will regularly work less than thirty-five (35) hours per week, detailed procedures for ensuring that Minority Group Persons, women, BVHP Area residents and San Francisco residents do not receive a disproportionate share of the part-time work.

(c) An agreement that not more than fifteen percent (15%) of the positions in any job category will be filled by persons transferred from other facilities operated by Developer, without the prior approval of the Agency. The Agency shall grant approval upon a showing that transfers in excess of fifteen percent (15%) do not unreasonably interfere with the objective of creating new jobs for BVHP Area and San Francisco residents and that such transfers further legitimate business needs of Developer. Transfers shall be counted in determining if Developer has met the employment goals for each ethnic group and women.

(d) Where required by the Agency, detailed procedures for utilizing Outreach Organizations as meaningful referral sources for job applicants.

Section 5. Arbitration of Disputes: Submission and Resolution of Disputes Concerning the Equal Opportunity Plan.

5.1 The purpose of this Section 5 is to establish procedures for resolving any disputes concerning Developer's or the Retail Tenant's EOP prior to Developer or the Retail Tenant occupying the Project Site and Agency Parcels covered by the Agreement. The arbitration provisions contained in this Section 5 are in addition to the provisions contained in Exhibit A to Attachment 24 of the Agreement.

5.2 Developer shall submit its EOP to the Agency one hundred and twenty (120) days prior to the earlier of the following: (1) the date Developer commences filling any permanent position for the Project Site and Agency Parcels, whether by new hire or transfer, or (2) the date the Project Site and Agency Parcels are scheduled to open; provided that if Developer has submitted its EOP to the Agency prior to the execution of the Agreement, the EOP shall be deemed submitted to the Agency thirty (30) days after the Agreement is executed.

5.3 During the first thirty (30) days after the EOP is submitted, the Agency and Developer shall negotiate in good faith concerning any alleged deficiencies in the EOP or any questions the Agency may have about the terms of the EOP or how it was prepared (e.g., the utilization analysis).

5.4 At the expiration of the thirty (30) days, the Agency shall advise Developer or the Retail Tenant, through a written Notice of Non-Compliance, of any alleged deficiency in the EOP remaining at the close of negotiations. The Notice shall state the specific basis for the alleged deficiency(ies) and the Agency's suggested cure.

5.5 Developer or the Retail Tenant shall advise the Agency, within ten (10) days of the mailing of the Notice of Non-Compliance, if Developer or the Retail Tenant accepts the cure. If Developer or Retail Tenant rejects the cure, either party may proceed immediately to arbitration by filing a Request for Arbitration on EOP with any member of the panel of

arbitrators attached as Rider 5 to Attachment 24 of the Agreement and serving said Request on the other party. The Request for Arbitration on EOP shall specify the issue presented and the relief requested. Where the Request seeks a temporary restraining order, the arbitrator shall hold a hearing not later than two (2) days after the filing and serving of the Request for Arbitration on EOP. In all other situations, unless the parties agree or the arbitrator orders otherwise, a hearing shall be held within fifteen (15) days after the filing and serving of the Request for Arbitration.

5.6 The arbitrator shall have the authority to:

(a) issue temporary restraining orders and preliminary and permanent injunctions, including, but not limited to, orders enjoining Developer or Retail Tenant from recruiting, screening or hiring (through new hires, transfers or otherwise) any person for permanent employment at the Project Site and Agency Parcels pending resolution of the alleged deficiency(ies) in the EOP;

(b) require the inclusion or exclusion of specific terms or provisions in the EOP based on a determination that the term(s) added or removed further the requirements and objectives of Exhibit A to Attachment 24 and this Rider 3. This subparagraph gives the arbitrator the authority to alter, amend, modify, add to or subtract from the EOP submitted by Developer or the Retail Tenant;

(c) issue such other relief deemed necessary to ensure that the EOP is written and implemented in a manner that satisfies the requirements and objectives of Exhibit A to Attachment 24 of the Agreement and this Rider 3.

Section 6. Arbitration of Disputes: Enforcement of Provisions Relating to Developer's or the Retail Tenant's Permanent Work Force, Including This Rider and Equal Opportunity Plans. Apart from the procedures established in Section 5, the Agency, Developer or the Retail Tenant may take any dispute concerning the interpretation, implementation or alleged breach of this Rider 3 or Developer's EOP to arbitration pursuant to the arbitration provisions of Exhibit A to Attachment 24 of the Agreement.

Section 7. Reports.

7.1 Developer and each Retail Tenant shall prepare, for its Project Site and Agency Parcel work force, reports for each job category which show by race, gender, residence (including BVHP Area), and, where required by the Agency, by transfer/non-transfer and referral source:

- (a) current work force composition;
- (b) applicants;
- (c) job offers;
- (d) hires;
- (e) rejections;

- (f) pending applications;
- (g) promotions and demotions; and
- (h) employees working, on average, less than thirty-five (35) hours per week.

7.2 The reports shall be submitted quarterly to the Agency, unless otherwise required by the Agency. In this regard Developer and each Retail Tenant agrees that if a significant number of positions are to be filled during a given period or other circumstances warrant, the Agency may require daily, weekly or monthly reports containing all or some of the above information. Developer and each Retail Tenant further agrees that the above reports may not be sufficient for monitoring Developer's or the tenant's performance in all circumstances, that they will negotiate in good faith concerning additional reports, and that the arbitrator shall have authority to require additional reports if the parties cannot agree.

Section 8. Term. The obligations of Developer and its Retail Tenants with respect to their permanent work forces as set forth in the Agreement, Exhibit A to Attachment 24 and this Rider 3 shall arise from the date Developer or its Retail Tenants first assigns employees to the Project Site and Agency Parcels on a permanent basis and remain in effect for ten (10) years thereafter.

RIDER 4

FIRST SOURCE REFERRAL HIRING AND JOB TRAINING

Developer shall comply with any applicable provision of the City's First Source Hiring Program pursuant to Ordinance No. 264-98, to the extent that, and so long as such provisions remain in full force and effect on a city-wide basis to established and future development. Developer acknowledges the application of the First Source Hiring Program, to the extent therein provided, to future transferees. Developer further acknowledges that there are economic impacts for non-compliance with the City's First Source Hiring Program.

RIDER 5

PANEL OF ARBITRATORS

Morris Davis, Esq.
8795 Mountain Boulevard
Oakland, California 94605
(510) 635-4509

John Kagel, Esq.
Kagel and Kagel
544 Market Street, Suite 401
San Francisco, California 94104
(415) 982-1438

William Bennett Turner
Rogers Joseph O'Donnell Quinn
311 California Street
San Francisco, California 94104
(415) 956-2828

ATTACHMENT 24

EXHIBIT B

ADDITIONAL BUSINESS, EMPLOYMENT, CONSTRUCTION ASSISTANCE/OPPORTUNITIES AND COMMUNITY BENEFITS PROGRAM

Section 1: Purpose. This Attachment 24, Exhibit B is intended to provide a conceptual outline of certain community benefit programs, in addition to the obligations contained in the Equal Opportunity Program, that Developer will develop working with the Agency and in consultation with representatives of the BVHP Area. Following Agency Commission approval of the DDA, Developer and the Agency will establish a working group that will draft the necessary implementing plans or other documents for the programs described below and the CAC will be consulted during this process. Except as set forth below, (1) binding agreements implementing these programs will be a condition precedent to the Close of Escrow for Parcel A-1 and (2) the costs of implementing these programs will be funded by Developer without recovery from the project revenues.

Section 2: Construction Assistance Program

2.1 Purpose: Because local contractors have expressed a concern that they lack the capability to obtain needed insurance, bonding, technical, and financial assistance in order to fully participate in the demolition and renovation of existing buildings, construction of infrastructure and new residential, cultural, commercial and community facilities at the Shipyard, a Construction Assistance Program will be provided.

2.2 Owner Consolidated Insurance Program (OCIP): The OCIP's primary benefit will be to allow contractors with a primary business address in the BVHP Area, who otherwise might not be able to meet the requirements to secure adequate insurance coverage ("BVHP Contractors"), to obtain insurance for work performed at the Shipyard. To the extent feasible, after meeting its obligations in the prior sentence, Developer will make its OCIP program available generally to Local M/WBEs. The current insurance market is difficult, especially for general liability premium pricing. Firms that have coverage may find they have coverage deficiencies on renewals. The OCIP will provide broad and consistent coverage terms for all eligible parties involved. Further, the OCIP will reduce the legal costs of construction defect litigation by providing for a single defense against a lawsuit/claim and by eliminating the "cross complaint" process. Also, the OCIP will allow the limits of coverages to be more efficiently used.

An OCIP is a "Wrap-up" insurance program designed to ensure adequate insurance coverage for BVHP Contractors. This will be a single, coordinated insurance program providing certain coverages for work performed at the Shipyard. Covered parties will include Developer and its related entities, and all eligible and enrolled local contractors/subcontractors selected to perform construction work at the Shipyard, and all of their eligible and enrolled sub-subcontractors. Eligibility requirements under the OCIP would be no more stringent than those

generally imposed on Developer under its OCIPs for other projects. Builder's Risk, Workers' Compensation, Automobile and Errors and Omissions are all non-OCIP covered items.

BVHP Contractors will be required to complete an OCIP Enrollment Application and return it as part of their bid and submit certificates and appropriate endorsements as required in the contract agreement for non-OCIP coverages such as Automobile and Workers' Compensation. The Developer will pay the OCIP premiums to the General Liability and Excess Liability carriers. BVHP Contractors, including the contractors, subcontractors and sub-subcontractors enrolled will be assessed a percentage of their contract price, which will show as a risk-adjusted back charge on their contract payment schedule. The OCIP will provide for appropriate risk tiers.

2.3 Surety Bond Program: The purpose of this program will be to supplement the Agency's Surety Bond Program for qualifying BVHP Contractors at the Shipyard. If otherwise qualified BVHP Contractors are unable to obtain a sufficient surety bond for their contracts and insufficient funds are available from the Agency's Surety Bond Program, then these BVHP Contractors will be able to obtain appropriate bonding for their contracts through the surety bond program that Developer will establish. Developer will establish a bond program through its own financing capability or through a third-party source to ensure that BVHP Contractors can obtain appropriate bonding for construction contracts at the Shipyard. Developer will further refine the details of this program, which must be approved by the Agency prior to implementation and which will include, among other elements, enrollment eligibility criteria that is no more rigorous than that required by the Agency's Surety Bond Program.

2.4 Technical Assistance: Developer will provide a contractor assistance position in the project office to be located in the Shipyard to serve as a liaison to contractors seeking contracts at the Shipyard. Duties of the position will include providing assistance to contractors with respect to the contract bidding process, the qualifications for the OCIP and Surety Bond Programs, and other programs available to contractors at the Shipyard. Developer will make a good faith effort to hire a local community resident to fill this position. The cost of this position shall be a project cost recoverable from project revenues.

Commencing at a reasonable time following the establishment of a project office at the Shipyard, Developer shall conduct workshops in coordination with community development organizations, the Agency and the City to address matters related to the construction industry such as worksite safety matters, accounting procedures, legal, insurance and labor matters and other topics. Developer shall solicit requests from BVHP Contractors for additional topics of interest to the BVHP Contractors.

2.5 Financial Assistance: Developer will actively utilize its relationships with financial institutions to introduce them to the Shipyard development, explain the general financial needs of the BVHP Contractors and assist BVHP Contractors in accessing necessary financing such as lines of credit, loans, or other financial assistance based on conventional underwriting practices.

2.6 MBE/WBE Mentorship Program: Developer will establish a program for mentoring MBE/WBE contractors.

Section 3: Community Builder Program

3.1 Purpose: The purpose of this program is to facilitate the participation of Qualified Community Builders (including, but not limited to, faith-based development organizations) in the vertical development of Community Builder Lots as defined in the DDA and consistent with the applicable provisions of Section 15 of the DDA.

Pursuant to Section 15 of the DDA, in order for Developer to exercise its right to develop approximately 30% of the Vertical Improvements, it must joint venture with Joint Venture Community Builders for such development. To the extent that Developer chooses not to joint venture with Joint Venture Community Builders (as defined below) to develop such portions of the Vertical Improvements, Independent Community Builders (as defined below) will be eligible to develop such portion of the Vertical Improvements not developed by a joint venture of Developer or its Affiliates and a Joint Venture Community Developer.

3.2 Qualified Community Builder: Qualified Community Builder shall include developers with a primary business address in the BVHP Area and/or owned by a resident of the BVHP Area and shall include both Joint Venture Community Builders and Independent Community Builders as defined below. As set forth in Section 3.1, Qualified Community Builders may include, but are not limited to, faith-based development organizations. Qualified Community Builders also may include BVHP Contractors under Section 2. Both Developer and the Agency shall make a Good Faith Effort to partner with Qualified Community Builders before seeking other partners.

(i) **Joint Venture Community Builder:** The Joint Venture Community Builder must perform duties that are economically significant to the joint venture and must actively and substantially participate in the day-to-day, financial and policy decision-making responsibilities of the joint venture. There must not be any formal or informal restrictions that limit the customary discretion of a joint venture partner with a significant ownership interest in the joint venture and the Joint Venture Community Builder must have authority to manage significant aspects of the joint venture business and the development of the improvements, including, without limitation, hiring and firing personnel, selecting and supervising the contractors, subcontractors, legal, financial and other consultants to the joint venture, approving the various development plans, construction documents, marketing strategies and project budget, negotiating and approving the various contracts in connection with the project, including, without limitation the Vertical DDA to be entered into with the Agency. For the joint venture to qualify as a Joint Venture Community Builder, the Agency must approve the instrument that sets forth the terms of the joint venture relationship between the Developer Affiliate and the Community Builder.

The selection of a Joint Venture Community Builder shall be at the sole discretion of Developer. To be considered for selection, Community Builders must submit sufficient information to demonstrate the Community Builder's capability to successfully undertake all activities necessary to complete the Vertical Improvements on the lot. This information shall include the following three areas:

1. Document technical qualifications related to the proposed development, including resumes of all members of the development entity, and the identification of licenses, certificates and relevant educational training.

2. Document direct or related experience, including but not limited to financial experience, construction, engineering and development experience, and provide a detailed explanation of previous development projects including project location, size, cost, capital and financing sources used, economic performance, project timeline, and a description of the role of the development entity or its members in the project.

3. To the extent available, provide the following financial information, including use of assistance under this and other programs available under the DDA: four years of annual credit reports, annual reports, audited financial statements of the development entity or its principal members and real estate portfolios, recent history of obtaining financing commitments, a description of all projects currently underway but not completed, including the financial commitment required of the development entity, identification of equity and debt capital and the relationship between the developer and the financing source. Provide detailed information regarding any litigation concerning a real estate joint venture which involved the development entity or any of its principal members.

(ii) **Independent Community Builder:** This term will include all of the evaluation criteria set forth in 3.2(i) above and the following: (1) Demonstrate the financial capability or access to minimum capital sources to purchase the lot at the Minimum Purchase Price in accordance with the terms set forth in the DDA; and (2) Demonstrate the ability to complete the Vertical Improvements on the Lot in accordance with the Schedule of Performance.

Developer will select a pool of Independent Community Builders eligible to bid on available Community Builder Lots. In accordance with the provisions of Section 15.4 of the DDA, the selected pool of Independent Community Builders shall participate in a competitive bid process for purchase of the Community Builder Lot.

3.3 Other Capacity Building Elements: The program will identify real estate and business development programs available at local colleges and training programs and provide information about these programs through a community outreach effort.

3.4 Community Outreach Program: Developer will develop a comprehensive community outreach program that will use print, web-based, local media and grassroots outreach organizations to inform BVHP Area residents and local businesses of the opportunities available under this program. This program will be similar in scope to the outreach programs described in Exhibit A to Attachment 24.

Section 4: Interim African Marketplace.

The purpose of the interim African Marketplace is to serve as an African-themed temporary festive outdoor setting for the display and sale of: a) arts, crafts, sculptures, fabrics and clothing, and books; and b) fresh, wholesome and healthy foods as commonly found in a Farmer's Market. Additionally, it will serve as a venue for the presentation of musical

performances, such as gospel, jazz and blues and African and world music. The musical events could occur in conjunction with, or independent of, the African Marketplace. The interim African Marketplace will establish the Shipyard as a music, entertainment, cultural, and tourist destination and will provide economic opportunities for local artists.

4.1 Location: An approximately 1.2-acre site to be agreed upon by the Agency, the CAC and Developer as a condition to Closing, which will allow for implementation of the African Marketplace in the first phase of the development.

4.2 Duration: The African Marketplace will be established during the implementation of Phase I and will continue until the permanent African Marketplace is established.

4.3 Implementation Strategy: Developer will fund the activities described in (a) through (e) below:

(a) Developer's planning/architectural consultant team working with a BVHP community-based arts and culture organization and a representative of the African Marketplace of Los Angeles will determine the character of the site, the proper mix, size and location of arts, crafts, clothing, food and other vendors, and the location of the performance area and parking. The consultant team shall also determine when the African Marketplace should operate and the frequency of cultural events (i.e. weekly, monthly).

(b) Developer's financial consultant will prepare an operations/financial feasibility study to determine the criteria for selecting vendors that will contribute to a successful African Marketplace.

(c) Additionally, the financial consultant will examine a revenue/cost structure that will yield at least a "break-even financial scenario" for operating the African Marketplace. The consultant will also recommend an African Marketplace Operator's leasing program, including lease rates for the African Marketplace Operator and its vendors. The consultant shall identify all potential sources of operating revenues (vendors rents and funds from sponsors like radio, television stations and beverage companies, etc.) as well as public funding sources to cover operating expenses (advertising, promotions, maintenance, operations, etc.). Developer will select the African Marketplace Operator.

(d) Developer's public relations consultant shall help create an attractive African Marketplace marketing brochure and website to assist with the vendors outreach program, and shall undertake other work to determine the best marketing and promotion a program for the African Marketplace as an integral part of the overall marketing and operations plan for Phase I. The purpose of this effort will be to determine how best to place the African Marketplace and the Shipyard "on the map" for local residents and the City and Bay Area region as a whole and to serve as a draw for tourists to the San Francisco Bay Area.

(e) Developer shall designate an approximately 1.2 acre site (see attachment) for the interim African Marketplace and shall pave the site (including a performance

area), provide utilities to the site, a parking area and trailer to serve as administrative and assistance center for the African Marketplace Operator and its vendors.

(f) The African Marketplace Operator shall be required to prepare an operations plan that includes, among other requirements, a vendor recruitment plan, a public relations and marketing plan, an outreach plan for working with local arts groups, ecumenical groups, merchant and business associations and others to identify performers and vendors for the African Marketplace, and a financial plan for the continued operation of the African Marketplace.

Section 5: Other Community Benefits

5.1 Cultural/Historical Recognition Program: Developer will develop a design program that will: (i) through the urban design process identify opportunities for recognizing and enhancing the cultural and historical context of the Shipyard and its surrounding community in both the development and design of the Shipyard; (ii) integrate cultural features and facilities throughout the Shipyard, starting with Phase I through the Interim African Marketplace; and (iii) provide opportunities for local artists (both at the Shipyard and from the surrounding community) to participate in creating public art for the Shipyard by working with artists at the Shipyard and in the community to identify appropriate locations and art forms for the public art program.

5.2 Space for Business Incubator Programs: Developer will provide space, including trailers, for a business incubator program. Rent for the incubator space will be set at the levels necessary to recover the costs of providing the space, without a profit, for so long as Developer (or its Affiliates) are engaged in development activities at the Shipyard. Additionally, Developer will identify, publicize and provide opportunities at the Shipyard for local start-up companies.

5.3 Home Buyers' Assistance Program: Developer will develop a Home Buyers' Assistance Program, including coordination with appropriate agencies and financial institutions such as its mortgage finance company UAMC, to provide qualified Shipyard home buyers with; (a) access to down payment assistance; (b) first-time buyer financing programs; and (c) homeownership counseling services. To the extent that these programs provide for specific interest rates, such rates will be determined at the time that the homes are available for purchase. This Program will include coordination with existing community based home buyers' assistance programs with successful track records.

5.4 Job Training and Employee Assistance Program: Developer will work with existing community based job training and assistance programs with successful track records to identify job training needs for the Shipyard, including social service needs that support job training programs. However, the jobs training and assistance program will be designed to specifically address the training and employment needs of the Shipyard, rather than be incorporated into more geographically expansive jobs programs. The jobs training and assistance program will include creation of after school, summer school and vacation employment via internships or partnering with local summer jobs programs. A process will be established to initially determine, and then to annually review, the job training and employee

assistance needs of the Shipyard and to determine which programs will receive this funding. Developer will provide financial support to programs that meet these identified needs as follows: Developer shall fund the agreed-upon programs, in such allocations as Developer and the Agency shall determine, in an aggregate amount of Two Hundred Twenty-Five Thousand Dollars (\$225,000.00) per year; of this annual amount One Hundred Twenty Thousand Dollars (\$120,000.00) will be an unrecoverable out-of-pocket cost to Developer, and the balance of One Hundred Five Thousand Dollars (\$105,000.00) will be recoverable as a Soft Cost. The initial annual amount shall be funded on the Close of Escrow and subsequent annual amounts shall be funded on the annual anniversary of the Close of Escrow until Substantial Completion of the Infrastructure. As part of its scheduling activities for construction of the Infrastructure, Developer will prepare, and circulate pursuant to the outreach requirements set forth in Attachment 24.A, a schedule showing start and end dates for the estimated required number of employees by trade as soon as feasible.

5.5 Local Community Priority Leasing: Developer will require commercial developers at the Shipyard to prepare a Local Community Priority Leasing Program. The program must include a marketing outreach effort to identify potential local tenants, to disseminate information through local media about leasing opportunities, and to establish goals for achieving a successful local community leasing program. Local tenant retail space will be equitably distributed throughout the retail areas, both geographically and qualitatively, so that local tenants enjoy equitable benefits in terms of pedestrian and vehicle access, visibility, proximity to anchor tenants and other desirable retail characteristics; local tenants will not be clustered in any particular area.

5.6 Working With Other Small Business Assistance Programs: Developer will establish or fund an existing local Small Business Assistance Program. This program will identify opportunities to assist small businesses in the BVHP Area to obtain contracts and participate in other business opportunities at the Shipyard.

ATTACHMENT 25

FINANCING AND REVENUE SHARING PLAN

This Financing and Revenue Sharing Plan ("Plan") is attached to and made a part of the Disposition and Development Agreement (the "Agreement") for Hunters Point, Phase 1 ("Phase 1"). Terms not defined in this Plan have the meanings given to them in the Agreement. The Agency and Developer are bound by this Plan as part of the obligations they assume, and benefits they receive, under the Agreement.

Section 1. Definitions.

Advance Interest Rate means Developer's cost of borrowing as calculated from time to time, but in no event to exceed eight and one half percent (8.5%) simple interest per annum. At any time interest is accruing at the Advance Interest Rate, Developer will provide its cost of borrowing on a quarterly basis, or more frequently if the Agency so requests, together with the methodology supporting such cost of borrowing.

Agency Land Return means the amount that results in an eleven percent (11%) per annum internal rate of return on the undistributed balance of the Land Value beginning from the Effective Date. The per annum internal rate of return is calculated as the compounded monthly internal rate of return. The Agency Land Return for each month is calculated using the formula set forth in Exhibit D attached hereto, and an example of such calculation is included in Exhibit D.

Approved Budget means the Preliminary Budget and any subsequent Budgets approved by the Agency (or deemed approved) pursuant to the processes described in Sections 6 and 7 below.

Approved Expenses means Developer's Hard Costs and Soft Costs, and the Agency's Costs (as defined in the Agreement), expended in developing Phase 1 that are incurred after the Effective Date of the Agreement and included in an Approved Budget. Approved Expenses exclude (i) costs that are not included in an Approved Budget, (ii) costs incurred before the Effective Date of the Agreement, (iii) Qualified Predevelopment Costs, (iv) Qualified Pre-Agreement Costs, (v) any amounts that cannot be reasonably verified through statements and invoices and (vi) any reimbursement for Developer's, or any Developer Affiliate's, overhead or personnel expenses, or payments to Developer or any Developer Affiliate; provided that, the Agency will not unreasonably withhold its approval of payments to Developer or any Developer Affiliate specifically identified in any proposed Budget for which Developer has provided written evidence (reasonably satisfactory to the Agency) that the proposed payments are not related to overhead or personnel expenses and do not exceed amounts that would be payable to non-related third parties in arms-length transactions for similar services within the City.

Arbiter has the meaning set forth in Section 7.2(d).

Bond Proceeds means the proceeds of any Mello-Roos Bonds issued for the development of Phase 1.

Bond Proceeds Account means an interest-bearing account for all Net Bond Proceeds.

Budget Disputes has the meaning set forth in Section 6.4.

City means the City and County of San Francisco.

Commence Construction means the commencement of substantial physical construction of the Infrastructure as part of a sustained and continuous construction plan.

Default Shortfall means a shortfall in revenue, whether through an overrun or acceleration of costs, or a delay or shortfall in Bond Proceeds or Gross Revenues, to the extent caused by a breach of any provision of the Agreement or the negligent act or omission or willful misconduct of Developer, its officers, employees, agents, contractors, subcontractors or others for whom it is responsible. A Default Shortfall may be triggered not only by a Developer Event of Default, as defined in the Agreement, but also by any event or circumstance that could become an Event of Default if not cured within any cure period granted to Developer, *i.e.*, a Default Shortfall may occur even if Developer avoids an Event of Default by curing the default within the specified cure period. A Default Shortfall is so defined because the Parties acknowledge that Developer must cure any default using its own funds, and not through a Reimbursable Mandatory Developer Advance (as defined below). If Developer, its officers, employees, agents, contractors, subcontractors or others for whom it is responsible commit a breach of any provision of the Agreement, are negligent or commit an act of willful misconduct, whether in supervising performance, designing and implementing a marketing program or otherwise, then any shortfall in revenue will be assumed to be a Default Shortfall, and Developer will bear the burden of proving that the breach, negligence or willful misconduct was (i) not the cause of the shortfall or (ii) was only a contributory cause, and if so, the extent of the contribution.

Developer's Outstanding Qualified Pre-Agreement Costs means the portion of Qualified Pre-Agreement Costs not paid out of Bond Proceeds pursuant to Section 2.2.

Developer's Outstanding Qualified Predevelopment Costs means the portion of Developer's Qualified Predevelopment Costs not paid out of Bond Proceeds pursuant to Section 2.2.

Developer Equity Return means the amount that results in a twenty-five percent (25%) per annum internal rate of return on the undistributed balance of the Developer's Outstanding Qualified Predevelopment Costs beginning from the Effective Date. The per annum internal rate of return is calculated as the compounded monthly internal rate of return. The Developer Equity Return for each month is calculated using the formula set forth in Exhibit D attached hereto, and an example of such calculation is included in Exhibit D.

Effective Date means the Effective Date of the Agreement.

Gross Revenues means all cash, notes or other payments or credits of any kind arising from disposition of Lots. Mandatory Developer Advances, Voluntary Agency Advances and Bond Proceeds are not included in Gross Revenues.

Hard Costs means Developer's out-of-pocket costs actually incurred and paid to licensed contractors and material suppliers for labor and materials required in connection with the demolition, grading and physical construction of the Infrastructure, as set forth in construction contracts and purchase orders approved by Owner. Hard Costs exclude (i) any amounts incurred prior to the date Developer Commences Construction, (ii) architectural, engineering or other design, consultant, attorney or other professional fees, (iii) any construction management fee, (iv) Qualified Predevelopment Costs, (v) Qualified Pre-Agreement Costs, (vi) Soft Costs, (vii) any amounts that cannot be reasonably verified through statements and invoices and (viii) any reimbursement for Developer's, or any Developer Affiliate's, overhead or personnel expenses, or payments to Developer or any Developer Affiliate; provided that, the Agency will not unreasonably withhold its approval of payments to Developer or any Developer Affiliate specifically identified in any proposed Budget for which Developer has provided written evidence (reasonably satisfactory to the Agency) that the proposed payments are not related to overhead or personnel expenses and do not exceed amounts that would be payable to non-related third parties in arms-length transactions for similar services within the City. Hard Costs include necessary building permit fees, bond premiums and similar costs that are calculated as a percentage of Hard Costs.

Horizontal Improvements or Infrastructure means the works of improvement described in the Infrastructure Plan attached as Attachment 9 to the Agreement, as it may be amended from time to time.

Land Proceeds Account means an interest-bearing account for all Gross Revenues.

Land Value means the amount of Thirty Million Dollars (\$30,000,000.00) treated as if expended on the Effective Date.

Lots has the meaning set forth in the Agreement; the Lots are shown in the map attached as Attachment 2 to the Agreement, as it may be amended from time to time.

Mandatory Developer Advance has the meaning set forth in Section 5.1.

Mediator has the meaning set forth in Section 7.2(a)

Mello-Roos Bonds means tax-exempt bonds issued under the Mello-Roos Community Facilities Act of 1982, California Government Code Sections 53311 *et seq.*

Mello-Roos Reserve has the meaning set forth in Section 3.4.

Net Bond Proceeds means the amount of any Bond Proceeds less the amounts of the Public Facility Predevelopment Costs, Public Facility Pre-Agreement Costs, and the initial funding of the Operating Reserve and the Mello-Roos Reserve, payable from Bond Proceeds immediately upon sale of the Mello-Roos Bonds as set forth in Section 2.2 below.

Net Revenues means Gross Revenues less the costs described in Section 3.3(a)-(e) below.

Non-Reimbursable Mandatory Developer Advance has the meaning set forth in Section 5.3.

Operating Reserve has the meaning set forth in Section 4.

Party means either the Agency or Developer; **Parties** means the Agency and Developer, collectively.

Preliminary Budget means the budget and project pro-forma attached as Exhibit A to this Attachment 25.

Project Accounts mean the Bond Proceeds Account and the Land Proceeds Account.

Project Decision Team or **PDT** means a team of four (4) persons, two (2) selected by the Agency and two (2) selected by Developer, who will consult with Developer on Budget matters.

Project Site means Parcels A-1 and B-1 as more particularly described in Attachment 1 to the Agreement, and as shown on the map attached as Attachment 2 to the Agreement.

Public Facility Approved Expenses means the portion and types of Approved Expenses that are eligible for reimbursement out of Bond Proceeds pursuant to applicable IRS rules and regulations, consistent with their tax-exempt status and customary underwriting standards related to the issuance of the Mello-Roos Bonds.

Public Facility Predevelopment Costs means the portion and types of Qualified Predevelopment Costs described on Exhibit B to this Attachment 25 that are eligible for reimbursement out of Bond Proceeds under applicable IRS rules and regulations, consistent with their tax-exempt status and customary underwriting standards related to the issuance of the Mello-Roos Bonds, up to a maximum amount not to exceed Ten Million Dollars (\$10,000,000.00).

Public Facility Pre-Agreement Costs means the portion and types of Qualified Pre-Agreement Costs described on Exhibit C to this Attachment 25 that are eligible for reimbursement out of Bond Proceeds under applicable IRS rules and regulations, consistent with their tax-exempt status and customary underwriting standards related to the issuance of the Mello-Roos Bonds.

Qualified Predevelopment Costs means the costs described on Exhibit B to this Attachment 25, plus interest at the rate of twelve percent (12%) per annum simple interest from the date the costs are paid by Developer until the Effective Date of the Agreement (the "Roll-Up Interest"). The Qualified Predevelopment Costs shall not exceed Twenty Million Dollars (\$20,000,000.00) and the Roll-Up Interest shall not exceed Five Million Dollars (\$5,000,000.00),

in a total aggregate amount not to exceed Twenty-Five Million Dollars (\$25,000,000.00).

Qualified Pre-Agreement Costs means the costs described on Exhibit C attached to this Attachment 25 in the amount of One Million Four Hundred Seventy-Four Thousand Five Hundred Dollars (\$1,474,500.00). Qualified Pre-Agreement Project Costs will not accrue interest.

Records has the meaning set forth in Section 8.

Reimbursable Mandatory Developer Advance has the meaning set forth in Section 5.2.

Shortfall and Reimbursement Agreement has the meaning set forth in Section 5.1.

Soft Costs means Developer's out-of-pocket costs actually incurred and paid to third-party providers for designing the Infrastructure and for marketing and selling the Lots, and comprising architectural, engineering, consultant, attorney and other professional fees, real property taxes and assessments for the Lots, insurance expenses, sales and marketing expenses, and customary closing costs incurred in connection with sales of the Lots. Soft Costs exclude (i) any amounts incurred prior to the Effective Date, (ii) Qualified Predevelopment Costs, (iii) Qualified Pre-Agreement Costs, (iv) Hard Costs, (v) any amounts that cannot be reasonably verified through statements and invoices and (vi) any reimbursement for Developer's, or any Developer Affiliate's, overhead or personnel expenses, or payments to Developer or any Developer Affiliate; provided that, the Agency will not unreasonably withhold its approval of payments to Developer or any Developer Affiliate specifically identified in any proposed Budget for which Developer has provided written evidence (reasonably satisfactory to the Agency) that the proposed payments are not related to overhead or personnel expenses and do not exceed amounts that would be payable to non-related third parties in arms-length transactions for similar services within the City. Soft Costs may include a construction management allowance calculated as a percentage of Hard Costs, not to exceed six percent (6%) of Hard Costs and a project management/task force allowance not to exceed four percent (4%) of Hard Costs.

Voluntary Agency Advance has the meaning set forth in Section 5.4.

Section 2. Financing.

2.1 General. In order to provide credit enhancements for issuance of Mello-Roos Bonds in the amounts (and in accordance with the other assumptions) set forth in the Preliminary Budget, at the Close of Escrow on Parcel A-1, Developer will cause the issuance of letter(s) of credit, or another form of credit enhancements acceptable to the underwriters for the issuance of the Mello-Roos Bonds. The letter(s) of credit or other form of credit enhancements will provide security for the Mello-Roos Bonds in the aggregate amount of not less than Twenty-Five Million Dollars (\$25,000,000.00), unless the Agency in its sole discretion agrees to a lesser amount. If required, at the Close of Escrow on Parcel B-1, Developer will provide letter(s) of credit or other form of credit enhancements for issuance of Mello-Roos Bonds in the amounts (and in accordance with the other assumptions) set forth in the then Approved Budget for Parcel B-1, consistent with the Agency's guidelines for such issuance. The Mello-Roos

Bonds will be secured by the letter(s) of credit or other form of credit enhancements and by the Project Site, without recourse to either the Agency's or the City's General Fund or the Agency's Tax Increment proceeds. The letter(s) of credit or other form of credit enhancements will be secured by corporate guarantees or other collateral from Developer or its Affiliates, without recourse to the Project Site, the Agency's or the City's General Fund or the Agency's Tax Increment proceeds. Financial institutions issuing the letter(s) of credit or other form of credit enhancements must have a rating of at least "A" from Moody's Investor's Service Inc. or Standard & Poor's Rating Service, or the equivalent rating from any successor rating agency mutually acceptable to the Parties on the date of issuance and at any later credit renewal date. Developer must provide substitute letter(s) or credit or other form of credit enhancements for any letter of credit or other form of credit enhancement that does not meet this rating standard on a credit renewal date. Subject to Developer complying with its obligations in this Section 2.1, the Agency will use commercially reasonable efforts to issue the Mello-Roos Bonds in the amounts set forth in the Preliminary Budget, and in accordance with the assumptions set forth in the Preliminary Budget and with customary underwriting standards.

2.2 Distribution. Immediately upon sale of the Mello-Roos Bonds, the Bond Proceeds will be used first to pay for the Public Facility Predevelopment Costs up to a maximum of Ten Million Dollars (\$10,000,000.00), then to pay the Public Facility Pre-Agreement Costs and then to initially fund the Mello-Roos Reserve and finally to fund the Operating Reserve. The remainder, the Net Bond Proceeds, will be deposited into the Bond Proceeds Account and may be used only to pay debt service on the Mello-Roos Bonds (and any mutually acceptable prepayments of principal, to the extent feasible), and the Public Facility Approved Expenses, as set forth in Section 3.2 below.

2.3 Accounting. Developer and the Agency will separately track all Bond Proceeds in order to comply with the requirements that (a) Bond Proceeds may be used only for purposes consistent with their tax exempt status and in accordance with this Agreement and (b) the amount of Public Facility Predevelopment Costs payable from Bond Proceeds do not exceed Ten Million Dollars (\$10,000,000.00).

Section 3. Project Accounts, Distributions of Gross Revenues, and Reserves.

3.1 Project Accounts. Developer will establish and maintain the Project Accounts with financial institutions approved by the Agency in writing. Developer will not commingle funds held in the Project Accounts with other funds held by Developer. The Agency will have a security interest in the Project Accounts superior to any other security interests. This security interest will be evidenced by a UCC-1 Financing Statement and a control agreement with each financial institution holding a Project Account. Developer will cooperate with the Agency in obtaining control agreement(s) and preparing and filing such Financing Statement and any continuation statements required to keep the Financing Statement effective. Any statements and all other records related to the Project Account will be available for the Agency's review and audit in accordance with Section 8 below.

3.2 Distributions from the Bond Proceeds Account. Distributions of Net Bond Proceeds from the Bond Proceeds Project Account shall be made only to pay debt service

on the Mello-Roos Bonds (and any mutually acceptable prepayments of principal, to the extent feasible), and the Public Facility Approved Expenses, as set forth in an Approved Budget.

3.3 Distributions from the Land Proceeds Account. Distributions of Gross Revenues from the Land Proceeds Account shall be made only for the following costs, in the following order of priority:

- (a) First, to pay debt service on the Mello-Roos Bonds, and any mutually acceptable prepayments of principal, to the extent feasible;
- (b) Next, to fully replenish the Mello-Roos Reserve, to the extent necessary;
- (c) Next, to pay for Approved Expenses as set forth in an Approved Budget;
- (d) Next to repay any Reimbursable Mandatory Developer Advances and Voluntary Agency Advances, plus accrued interest at the Advance Interest Rate, in pro-rata shares, as provided in Section 5.5;
- (e) Next, to repay any Developer's Outstanding Qualified Pre-Agreement Costs, without interest thereon; and
- (f) Next, to distribute Net Revenues to Developer and Agency as set forth in Section 4.

3.4 Mello-Roos Reserves. Developer will maintain such reserves as may be required under customary underwriting requirements for issuance of the Mello-Roos Bonds (the "Mello-Roos Reserve") in the Bond Proceeds Account. To the extent that Gross Revenues or Bond Proceeds are insufficient to fund the Mello-Roos Reserve, such deficiency shall be funded by Developer as a Reimbursable Mandatory Developer Advance.

Section 4. Distributions of Net Revenues.

Generally distributions of Net Revenues from the Land Proceeds Account will be made monthly. However, no distributions of Net Revenues will be made unless and until there are sufficient reserves in the Land Proceeds Account to fund one hundred percent (100%) of the budgeted operating and capital needs of Phase 1, excluding debt service on the Mello-Roos Bonds, and net of any projected Gross Revenues (both as projected in the then Approved Budget) for the following three (3) month period (the "Operating Reserve"). If the Operating Reserve requirement is met, then distributions of Net Revenues will be made as follows:

First, forty percent (40%) to Developer and sixty percent (60%) to the Agency until both: (a) Developer has received an amount under this provision and Section 3 equal to Developer's Outstanding Qualified Predevelopment Costs plus the Developer Equity Return and (b) the Agency has received an amount equal to the Land Value plus the Agency Land Return;

Next, once either Party has received its respective specified return under (a) or

(b) above, one hundred percent (100%) to the other Party until such other party has received its specified return; and

Next, fifty percent (50%) to Developer and fifty percent (50%) to the Agency.

Section 5. Mandatory Developer Advances and Voluntary Agency Advances.

5.1 Mandatory Developer Advances. If at any time there are insufficient funds in the Project Accounts to pay Approved Expenses payable from Gross Revenues or Bond Proceeds, whether through an overrun or acceleration of costs, a delay or shortfall in Bond Proceeds or Gross Revenues, or from any other cause, Developer will advance the funds required to assure completion of all of Phase 1 (Parcel A-1 and Parcel B-1) (a "Mandatory Developer Advance"). To the extent required under customary underwriting standards or recommended by counsel in order to improve marketability of the Mello-Roos Bonds, Developer's obligation to complete all of Phase 1 will be memorialized in a Shortfall and Reimbursement Agreement consistent with such standards or recommendations. Developer's obligation to complete all of Phase 1, and Developer's obligations under the Shortfall and Reimbursement Agreement (if one is required), will be guaranteed by Lennar Corporation and LNR Property Corporation, as part of the Guaranty of Developer's obligations under the Agreement in the form attached as Attachment 8 to the Agreement.

5.2 If the shortfall is not a Default Shortfall, then Developer will be entitled to a distribution in the amount of its Mandatory Developer Advance together with accrued interest at the Advance Interest Rate computed monthly on the principal balance thereof from time to time outstanding from and including the date such Advance was made to and including the date such Advance is repaid. In that event, the Mandatory Developer Advance will become a "Reimbursable Mandatory Developer Advance."

5.3 If the shortfall is a Default Shortfall, then Developer will be required to make a Mandatory Developer Advance at its sole cost without any reimbursement, interest or other compensation (a "Non-Reimbursable Mandatory Developer Advance").

5.4 Voluntary Agency Advances. Subject to Developer's prior written approval, not to be unreasonably withheld or delayed, the Agency in its sole and absolute discretion may elect (but will never be required) to make a voluntary advance to the Project Account, to be used only for the purposes specified by the Agency at the time the Agency seeks Developer's approval (a "Voluntary Agency Advance"). The Agency will be entitled to return of its Voluntary Agency Advance and accrued interest at the Advance Interest Rate, from and including the date such Advance was made to and including the date such Advance is repaid.

5.5 Timing of Repayment of Reimbursable Mandatory Developer Advances and Voluntary Agency Advances. Reimbursable Mandatory Developer Advances and Voluntary Agency Advances, plus accrued interest at the Advance Interest Rate, will be paid in the order set forth in Section 3.3 above. If at any time both Reimbursable Mandatory Developer Advances and Voluntary Agency Advances are outstanding, they will be paid in the same proportions that each bears to the total of such Advances then outstanding, plus interest at the Advance Interest Rate, until both such Advances and all accrued interest are paid in full. For

example, if the Reimbursable Mandatory Developer Advances plus interest equal Sixty Thousand Dollars (\$60,000.00) and the Voluntary Agency Advances plus interest equal Forty Thousand Dollars (\$40,000.00), then each payment shall be allocated sixty percent (60%) to Developer and forty percent (40%) to the Agency until both such Advances and all accrued interest are paid in full.

5.6 Procedures for Advances. Prior to making any Mandatory Developer Advance or Voluntary Agency Advance, the Party making the Advance will consult with the other Party as to the need for, and timing, uses and amounts of, the Advance. Any Voluntary Agency Advance requires Developer's consent, and any Mandatory Developer Advance requires the Agency's consent. In both cases consent will not be unreasonably withheld or delayed. The then Approved Budget will be revised to show the type, amount and time of any Advance, as well as the amount and time of any repayment, allocating the repayment between interest and principal.

Section 6. Approved Budget.

6.1 Caps on Predevelopment and Pre-Agreement Costs. Developer and the Agency have agreed upon certain caps for Qualified Predevelopment Costs and Qualified Pre-Agreement Costs. The amount and nature of those costs are described in Exhibits B and C attached hereto. Any amounts incurred by Developer in producing the deliverables and performing the tasks described therein in excess of those caps will be absorbed by Developer without reimbursement. Notwithstanding the foregoing, as set forth in the Phase 2 Exclusive Negotiating Agreement (as defined in the Agreement) entered into by Developer and the Agency on the Effective Date of the Agreement, up to Three Million One Hundred Six Thousand Five Hundred Dollars (\$3,106,500.00) of the earliest incurred Qualified Predevelopment Costs, subject to verification, will be deferred to Phase 2, but these deferred amounts will not accrue interest.

6.2 Preliminary Budget. Developer and the Agency have also agreed on a Preliminary Budget commencing with the Effective Date, to be updated on a specified basis by Developer, subject to the Agency's approval, as set forth below. The Preliminary Budget assumes that Close of Escrow on Parcel A-1 is earlier than on Parcel B-1, but that commercial Lots are available for sale on Parcel B-1 from and after the fourth (4th) anniversary of Close of Escrow on Parcel A-1. The Preliminary Budget includes, among other things, (a) the estimated Bond Proceeds and Lot sale proceeds, the uses of those Bond Proceeds and Lot sale proceeds and the sources for payment of the debt service on the Mello-Roos Bonds, (b) the amount of Developer's Qualified Predevelopment Costs, Public Facility Predevelopment Costs, Qualified Pre-Agreement Project Costs, Public Facility Pre-Agreement Project Costs, Hard Costs, Soft Costs and Approved Expenses and the sources for repayment of those items, (c) a detailed Project cost breakdown of major cost categories, (d) any expected Voluntary Agency Advances and expected Reimbursable Mandatory Developer Advances, (e) cash flow projections and (f) major development, construction and marketing milestones, the estimated dates of achievement and the revenues and costs associated with the milestones, including a specified order in which Lots will be developed with Horizontal Improvements and then sold. In part, this order is based on the need for Lot sales proceeds to fund further Horizontal Improvements, and therefore the order recognizes that sales of certain Affiliate Lots may be more likely to generate

the required revenue in the early stages of Phase 1. As referenced in Section 15 of the Agreement, the Preliminary Budget also incorporates a Schedule setting forth a Minimum Purchase Price for each Lot, which will be subject to confidentiality restrictions mutually acceptable to the Agency and to Developer. The relevant Minimum Purchase Prices are incorporated in the Preliminary Budget and cannot be changed without the prior written consent of both Developer and the Agency. Among other things, the Preliminary Budget sets forth a projected distribution of Net Revenues based on the assumptions set forth in that Preliminary Budget, but the Parties acknowledge that the actual facts may differ from those assumptions.

6.3 Initial Update of Preliminary Budget at Close of Escrow. In

consultation with the PDT, Developer will update the Preliminary Budget, and provide a copy of the proposed update to the Agency together with supporting information substantiating all proposed changes thereto (in a form reasonably acceptable to the Agency), no more than sixty (60) and no less than thirty (30) days prior to Close of Escrow. If the PDT unanimously approves the update, then the approved update will be the Approved Budget. If the PDT fails to unanimously approve the update, then the Agency and Developer will consult in an attempt to reach agreement by the Close of Escrow, or such later date as they mutually agree, using the following standards:

(a) Qualified Predevelopment Costs and Qualified Pre-Agreement Costs cannot exceed the specified caps and, subject to those caps, the Agency will approve these categories of Costs so long as Developer produces paid invoices or other verification reasonably acceptable to the Agency supporting the amounts claimed; provided that, the allocation of such Costs, and of Approved Expenses, to the Public Facility category must be supported by opinions of bond counsel reasonably acceptable to the Agency to the extent the same are paid with Bond Proceeds. Disputes as to this category of Costs are not Budget Disputes and will be resolved under the verification provisions of Section 8.

(b) Hard Costs do not have specified caps and the Agency will approve Hard Costs so long as (i) the Hard Costs claimed result from competitive bids from at least three (3) responsible bidders not Affiliated with Developer, with the lowest responsive bidder prevailing, unless Developer obtains Agency's prior written consent to a negotiated bid on the basis that the negotiated bid will result in a superior work product at a competitive price and (ii) Developer produces paid invoices or other verification reasonably acceptable to the Agency supporting the amounts claimed; provided that, the allocation of Hard Costs to the Public Facility category must be supported by opinions of bond counsel reasonably acceptable to the Agency to the extent Hard Costs are paid with Bond Proceeds. Disputes as to Hard Costs are not Budget Disputes and will be resolved under the verification provisions of Section 8, except as to the adequacy of competitive bid procedures or whether the Agency consented to a negotiated bid, both of which are Budget Disputes.

(c) Soft Costs must also be supported by paid invoices or other verification reasonably acceptable to the Agency, but in addition Developer must demonstrate to the Agency's reasonable satisfaction that that the Soft Costs meet the criteria for Approved Expenses, were necessarily incurred to construct the Infrastructure as required by the Agreement and represent the lowest commercially reasonable cost considering the type of labor or materials involved, the then competitive market for such labor and materials, any relevant time pressures

and the other criteria imposed by the Agreement, e.g., the Equal Opportunity Program and Community Benefits Provided by Developer attached as Attachment 24. The allocation of Soft Costs to the Public Facility category must be supported by opinions of bond counsel reasonably acceptable to the Agency to the extent Soft Costs are paid with Bond Proceeds. Disputes as to Soft Costs are Budget Disputes and will be resolved under Section 7, although the verification provisions of Section 8 will also apply.

(d) The Agency will approve increases in the Preliminary or then Approved Budget to the extent the increases reflect actual, verifiable increases directly relating to changes to approved Construction Documents requested by the Agency, to the extent the Agency's requested changes are inconsistent with the Infrastructure Plan attached as Attachment 9 to the Agreement. Disputes as to the Agency's approval are Budget Disputes and will be resolved under Section 7.

(e) The Agency will rely on Developer's estimates of Gross Revenues, and of the timing of Lot sales, unless Developer has been materially inaccurate in its estimates for the prior two (2) annual budget cycles, in which event Developer will have to support its estimates with expert opinions reasonably satisfactory to the Agency. Disputes as to Gross Revenues are Budget Disputes and will be resolved under Section 7.

(f) The amount and timing of Bond Proceeds and Voluntary Agency Advances will be based on the most recent information available. Disputes as to the amount or timing of Bond Proceeds are Budget Disputes and will be resolved under Section 7; provided that, the Agency will never be obligated to make a Voluntary Agency Advance and the disputes specified in Section 6.4 (a) and (b) are not Budget Disputes and shall be resolved only by agreement between the Parties or by litigation.

(g) The amount and timing of Mandatory Developer Advances will be a function of the other components of the Preliminary or then Approved Budget. Disputes as to the amount and timing of Mandatory Developer Advances are Budget Disputes and will be resolved under Section 7; provided that, Developer will make Mandatory Developer Advances when required under this Attachment 25.

6.4 Disputes and Operation Pending Disputes. Any dispute as to verification will be subject to the audit procedures set forth in Section 8. Any other disputes regarding Budget matters ("Budget Disputes") will be subject to the dispute resolution procedure in Section 7; provided that, any disputes as to (a) the Minimum Purchase Price for each Lot as set forth in the Preliminary Budget and (b) whether Qualified Predevelopment Costs, Qualified Pre-Agreement Costs or Approved Expenses should be allocated to the Public Facility category (to the extent the same are paid from Bond Proceeds), are not Budget Disputes and shall be resolved only by agreement between the Parties or by litigation. Pending agreement or other resolution of any dispute, Developer will proceed in accordance with (i) elements of the proposed Budget that are not subject to dispute and (ii) all other elements of the proposed Budget in accordance with Developer's positions, pending resolution of the dispute, unless the Agency in its sole and absolute discretion directs otherwise; provided, however, that Developer may elect not to proceed in the event of a Construction Dispute (as specified in the Agreement) until such Construction Dispute is resolved. If Developer proceeds pending resolution of a dispute, then as

part of the ultimate agreement or resolution between Developer and the Agency, they shall prepare a written reconciliation of the amounts paid by Developer and the amounts that should have been paid in accordance with the final agreement or resolution, and Developer and the Agency shall then make any necessary adjustments between them based on the reconciliation. Following the Parties' agreement on all updated items (or the final resolution of any differences between them), the Preliminary Budget will be known as the "Approved Budget".

6.5 Annual Update of Approved Budgets. In consultation with the PDT, Developer will update the then Approved Budget on an annual basis no more than sixty (60) and no less than thirty (30) days prior to the end of Developer's fiscal year. The annual update will be subject to the same procedures for review, approval, dispute resolution and operation pending dispute resolution as provided in Sections 6.3 and 6.4.

6.6 Other Changes to Approved Budgets. The Agency's approval is required of any (a) changes to a line item in the then Approved Budget that exceeds ten percent (10%) of the line item, (b) transfer between line items in excess of ten percent (10%) of the lesser of the line items and (c) changes that reduce the Net Revenue shown in the then Approved Budget by more than ten percent (10%). Developer will operate within each line item of the Approved Budget, subject to the above contingency and Sections 6.4 and 6.5. If Developer desires to change an Approved Budget other than in accordance with the annual review process, then it will consult with the PDT and provide a copy of the proposed change to the Agency no more than sixty (60) and no less than thirty (30) days prior to the date on which Developer proposes to implement the change. The proposed change will be subject to the same procedures for review, approval, dispute resolution and operation pending dispute resolution as provided in Sections 6.3 and 6.4.

6.7 Expenses Subject to Verification. All Approved Expenses, Hard Costs, Soft Costs, Qualified Predevelopment Costs and Qualified Pre-Agreement costs are subject to confirmation by an inspection and independent audit performed by an auditor selected by the Agency, in accordance with Section 8 below.

Section 7. Dispute Resolution.

7.1 Good-Faith Negotiation by Parties. The Parties shall attempt to resolve, through good-faith negotiation among themselves, any Budget Dispute subject to this Section 7 for a period of ten (10) days after the Budget Dispute is raised by any Party in a written notice to the other Party. Each Party shall be represented in such negotiations by one (1) or more representatives with decision making and settlement authority sufficient to resolve the Budget Dispute, subject to approval of the Party's governing body, where required.

7.2 Mediation and Arbitration. Any Budget Dispute that cannot be resolved by the Parties during such ten (10) day good-faith negotiation period shall be submitted first to mediation within five (5) days after conclusion of the good-faith negotiation period described in Section 7.1.

(a) The mediator ("Mediator") will be the first available Mediator from a list of at least three (3) pre-approved Mediators to be agreed upon by the Agency and

Developer as a condition to Closing, starting with the first named Mediator and continuing to cycle through the list as Mediators are required, provided that no Mediator will mediate consecutive disputes. If none of the Mediators listed is able or willing to serve, a single neutral Mediator shall be appointed by JAMS/Endispute in San Francisco, California. The Mediator appointed must have at least ten (10) years of experience in resolving disputes similar to the dispute at issue.

(b) The mediation shall be conducted according to the rules established by JAMS/Endispute; provided that, the mediation must be completed within thirty (30) days after the Mediator is appointed.

(c) If the dispute has not been resolved through an agreement in principle among the Parties within such thirty (30) day mediation period, the matter will be submitted to arbitration.

(d) The arbitrator ("Arbiter") will be the first available arbitrator from a list of at least three (3) pre-approved Arbiters to be agreed upon by the Agency and Developer as a condition to Closing, starting with the first named Arbiter and continuing to cycle through the list as Arbiters are required, provided that no Arbiter will arbitrate consecutive disputes. If none of the Arbiters listed is able or willing to serve, a single neutral Arbiter shall be appointed by JAMS/Endispute in San Francisco, California. The Arbiter appointed must have at least ten (10) years of experience in resolving disputes similar to the dispute at issue.

(e) The arbitration shall be conducted according to the rules established by JAMS/Endispute. Judgment upon the Arbiter's decision may be entered in any court of competent jurisdiction.

(f) Initially, each Party will advance fifty percent (50%) of the fees and costs of the Mediator and the Arbiter, if any. The non-prevailing Party in the arbitration shall pay the Mediator's and Arbiter's fees and costs. The Arbiter shall have the right to assess all or any part of any expenses to one of the Parties as sanctions. If the Arbiter does not assess the expenses, and the Parties do not otherwise agree, the expenses of each Party in preparing for and participating in the mediation and arbitration, if any, shall be borne by each such Party.

(g) The provisions of this Section 7 shall constitute the sole and exclusive provisions for the resolution of any and all Budget Disputes subject to this Section 7, whether arising before or after the Effective Date.

7.3 Acknowledgment.

NOTICE: BY INITIALING IN THE SPACE BELOW YOU ARE AGREEING TO HAVE ANY DISPUTE ARISING OUT OF THE MATTERS INCLUDED IN SECTION 7 DECIDED BY NEUTRAL ARBITRATION AS PROVIDED BY CALIFORNIA LAW AND YOU ARE GIVING UP ANY RIGHTS YOU MIGHT POSSESS TO HAVE THE DISPUTE LITIGATED IN A COURT OR JURY TRIAL. BY INITIALING IN THE SPACE BELOW YOU ARE GIVING UP YOUR JUDICIAL RIGHTS TO DISCOVERY AND APPEAL UNLESS THOSE RIGHTS ARE SPECIFICALLY INCLUDED IN SECTION 7. IF YOU REFUSE TO SUBMIT TO

ARBITRATION AFTER AGREEING TO THIS PROVISION YOU MAY BE COMPELLED TO ARBITRATE UNDER THE AUTHORITY OF THE CALIFORNIA CODE OF CIVIL PROCEDURE. YOUR AGREEMENT TO THIS PROVISION IS VOLUNTARY. WE HAVE READ AND UNDERSTAND THE FOREGOING AND AGREE TO SUBMIT DISPUTES ARISING OUT OF THE MATTERS INCLUDED IN SECTION 7 TO NEUTRAL ARBITRATION IN ACCORDANCE WITH THAT SECTION.

Agreed to and accepted by: Agency: MR Developer: [Signature]

Section 8. Records and Audit Rights.

Developer will maintain books and records of all receipts and disbursements related to Phase 1 in accordance with generally accepted accounting principles consistently applied, or in another auditable form approved by the Agency in advance and in writing (collectively, the "Records"). Developer will maintain the Records in the City or at a mutually agreeable storage facility for at least ten (10) years after the Agency issues a Certificate of Completion for the Horizontal Improvements in Phase 1. The Agency shall have the right at any time, after reasonable notice, to inspect and copy Developer's Records. If, after an inspection, the Agency disputes any matters set forth in the Records, or any payments or disbursements made by Developer, then the Agency shall be entitled to retain an independent certified public accountant to copy, review and/or audit the Records, after reasonable notice and at reasonable times. If the audit or review shows any discrepancy, then Developer will correct the discrepancy, and the Party owing funds will deposit such funds in the Project Account, or pay such funds to the other Party, as the case may be, within thirty (30) days after the audit results are made available to Developer and the Agency. The deposit or payment will include interest at the Advance Interest Rate from and after the date the discrepancy arose to and including the date the discrepancy is rectified. The Agency will pay the costs of any inspection, audit or review, unless the audit reveals a discrepancy of more than two percent (2%) of the amount properly due, exclusive of interest, in which case Developer will pay the cost of the inspection, review or audit within thirty (30) days after receipt of an invoice from the Agency.

LIST OF EXHIBITS

- Exhibit A** **Preliminary Budget and Project Pro Forma**
- Exhibit B** **Description of Qualified Predevelopment Costs**
- Exhibit C** **Description of Pre-Agreement Costs**
- Exhibit D** **Agency Land Return and Developer Equity
Return Formulas and Examples**

**Exhibit A
Budget**

Description	April 5, 2005	
	100% Construction Drawings	
	Total	Percent of Direct Costs
INCOME AND EXPENSES		
Income		
Residential Land Sales	124,922,477	
Non Residential Land Sales	10,500,000	
<u>Less Closing Costs</u>	<u>(1,354,225)</u>	
<i>Total Land Sales</i>	134,068,252	
Qualified Predevelopment Costs		
Environmental	2,751,500	
PDC	2,735,843	
Navy Conveyance	1,627,084	
Development Transaction	3,068,580	
SFRA/City Administration Costs	6,756,702	
Infrastructure	2,208,832	
Planning & Entitlements	1,302,760	
Fees/Permits	6,025	
Subdivision	213,561	
Miscellaneous Costs	89,137	
<u>Less Costs Deferred to Phase II</u>	<u>(760,023)</u>	
Subtotal Qualified Predevelopment Costs	20,000,000	
<u>Interest on Qualified Predevelopment Costs</u>	<u>5,000,000</u>	
<i>Total Qualified Predevelopment Costs</i>	25,000,000	
Infrastructure Construction Costs		
Parcel A' B'		
General Items	1,620,870	2%
Grading and Landslide Repair	9,898,817	13%
Demolition and Deconstruction	5,138,580	7%
Roadway Items	4,336,287	6%
Specialty Items	6,501,782	9%
Traffic Items	557,788	1%
Utilities	12,285,575	16%
Navy Storm water Solution	1,583,110	2%
Permits, Bonds, Fees	970,207	1%
Post Construction Award Services	2,020,181	3%
PG&E	3,996,000	5%
Peer Review	150,000	0%
Block 1 - Phase 1	-	0%
Phase 2 Grading	1,260,000	2%
Additional Environmental	750,000	1%
Six Acre Parcel	-	0%
Bonding Costs due to Delays	50,000	0%
Mobilization / Demobilization Impacts	680,000	1%
African Market Place Construction	250,000	0%
Open Space & Streetscapes		
Landscape and Irrigation - Major Streets	-	0%
Landscape and Irrigation - Minor Streets	-	0%
Hilltop Open Space	-	0%
Hillside Neighborhood Open Space	-	0%
Galvez Steps	-	0%
Bike Path	-	0%
A' Open Space	5,260,677	7%
B' Open Space	1,132,462	2%
B' Waterfront Open Space	5,673,436	8%
Open Space Contingency/Overhead	-	0%
<u>Subtotal Open Space & Streetscapes</u>	<u>12,066,575</u>	<u>16%</u>
Deduction for Griffith and Donahue Street	(1)	(1,000,000)
Contingency	4,378,811	6%
Design Fee	3,149,989	4%
Pre-Agreement Design Fee	1,126,585	2%
Construction Management	2,557,875	3%
Construction Services	<u>383,681</u>	<u>1%</u>
<i>Total Infrastructure Construction Costs</i>	74,712,713	100%
Indirect Costs		
Non-Infrastructure Pre-Agreement Project Costs	348,916	0%
Planning/Entitlement	973,587	1%
Environmental	427,500	1%
Navy Conveyance	84,909	0%
Development Transaction	497,000	1%
Permits & Fees (SFFD/SFWD Const. Fees)	205,525	0%

**Exhibit A
Budget**

Description	April 5, 2005	
	100% Construction Drawings	
	Total	Percent of Direct Costs
Subdivision	588,000	1%
Title	245,000	0%
Environmental Insurance	693,825	1%
Project Management/Task Force	(2) 4,487,958	6%
Agency Costs	(3) 1,575,000	2%
City Inspection Costs	(4) 2,325,000	3%
City Subdivision/Design/Project Management	(4) 2,025,000	3%
Appraisals	350,000	0%
Sales/Mktg	2,145,092	3%
Litigation "Prop 209"/CEQA	(5) 100,000	0%
Additional Developer Closing Costs	3,477,049	5%
Agency Costs Incurred Prior to DDA (10/03-11/03)	866,275	1%
Agency Costs Incurred After DDA (12/03-12/04)	2,254,706	3%
Agency Costs Incurred After DDA (1/05-3/05)	(6) 250,000	0%
<u>Community Benefits</u>	<u>3,835,000</u>	<u>5%</u>
<i>Indirect Costs</i>	27,755,341	37%
Financing Costs (see detail below)	5,886,712	
<i>Total Costs</i>	133,354,766	
<i>Total Costs (excluding interest rollup on predevelopment cost)</i>	128,354,766	
<i>Total Costs (excluding predevelopment cost)</i>	108,354,766	

FINANCING DETAIL

Net Financing Proceeds	40,800,000
Infrastructure Financing Costs	
Principal & Interest on Bonds	1,613,119
Mello Issuance Credit Enhancement Costs	708,544
Interest Paid on Advances	
Mandatory Developer Advances	3,428,611
Voluntary Agency Advances	<u>136,437</u>
Total Financing Costs	5,886,712

DEVELOPER/AGENCY PARTICIPATION

Lennar/BVHP Cumulative Cashflow	29,848,801
Less Predevelopment Costs	(20,000,000)
Net Lennar/BVHP Cumulative Cashflow	9,848,801
Agency Cumulative Cashflow	30,916,274

Notes

- (1) Deduction from the budget represents the improvements to Griffith and Donahue Street that fall outside of the project.
- (2) Lennar has reduced it's Project Management budget by \$300,000
- (3) SFRA Project Management fees have been reduced by \$600,000.
- (4) Assumes DPW's Bureau of Construction Management (BCM) services are provided by outside sources (\$300,000 and \$150,000 reduction in A' and B', respectively)
- (5) This budgeted amount assumes that only phases 1-3 of the CEQA legal budget will be incurred
- (6) Estimated based on invoices received to date.

As of April 5, 2005 this budget that has been reviewed and approved by both Lennar and the Redevelopment Agency

Lino Campanile

Kurt Fuchs

Exhibit A
Monthly Cashflow and Revenue Participation
Phase 1 Development of the Hunters Point Shipyard

		Dec-03 Month 3	Jan-04 Month 4	Feb-04 Month 5	Mar-04 Month 6	Apr-04 Month 7	May-04 Month 8	Jun-04 Month 9	Jul-04 Month 10	Aug-04 Month 11	Sep-04 Month 12	Oct-04 Month 13	Nov-04 Month 14	Dec-04 Month 15	Jan-05 Month 16	Feb-05 Month 17
	Total															
INCOME																
Land Sales																
Residential Land Sales																
A'	106,252,259	0	0	0	0	0	0	0	0	0	0	0	0	0	0	0
B'	18,670,218	0	0	0	0	0	0	0	0	0	0	0	0	0	0	0
Commercial Land Sales	10,500,000	0	0	0	0	0	0	0	0	0	0	0	0	0	0	0
Gross Land Sales	135,422,477	0	0	0	0	0	0	0	0	0	0	0	0	0	0	0
Less Closing Costs	-1,354,225	0	0	0	0	0	0	0	0	0	0	0	0	0	0	0
Net Land Sales	134,068,252	0	0	0	0	0	0	0	0	0	0	0	0	0	0	0
COSTS																
Qualifying Project Costs																
Qualified Pre Development Costs	25,000,000	25,000,000														
Qualified Pre Dev Costs In Excess of \$25M	0	0														
Infrastructure Construction Costs	74,887,777	1,421,111	111,865	0	180,951	83,243	0	129,851	178,881	736,405	267,021	51,016	136,100	1,979	361,325	54,890
Indirect Costs	27,368,513	889,708	107,818	72,171	345,588	201,938	107,884	288,104	190,755	223,669	312,949	349,022	389,646	166,795	945,348	296,459
Total Costs	127,256,290	27,310,819	219,683	72,171	526,539	285,181	107,884	417,955	369,636	960,074	579,971	400,038	525,746	168,774	1,306,673	351,349
NET CASHFLOW BEFORE FINANCING																
Net Cashflow	6,811,962	-27,310,819	-219,683	-72,171	-526,539	-285,181	-107,884	-417,955	-369,636	-960,074	-579,971	-400,038	-525,746	-168,774	-1,306,673	-351,349
FINANCING																
Mello Roos Financing (Net)	40,800,000	0	0	0	0	0	0	0	0	0	0	0	0	0	0	0
Assessments and LOC Costs	-2,321,664	0	0	0	0	0	0	0	0	0	0	0	0	0	0	0
CASHFLOW PRIOR TO DEVELOPER SHORTFALL																
	45,290,298	-27,310,819	-219,683	-72,171	-526,539	-285,181	-107,884	-417,955	-369,636	-960,074	-579,971	-400,038	-525,746	-168,774	-1,306,673	-351,349
Developer Shortfall Financing																
Beginning Balance	Max 41,426,030	89,870	90,507	459,738	535,157	991,033	1,248,938	1,365,561	1,739,614	2,047,765	2,719,151	3,208,138	3,609,361	4,103,984	4,300,124	5,525,474
New Shortfall Advance	Total 65,626,138	0	368,594	72,171	452,117	250,945	107,884	364,550	296,065	657,204	470,150	379,056	469,770	167,960	1,195,980	328,774
New Balance		89,870	459,101	531,909	987,274	1,241,977	1,356,823	1,730,111	2,035,680	2,704,969	3,189,300	3,587,193	4,079,131	4,271,944	5,496,104	5,854,247
Interest on Debt	8.5% 3,428,611	637	637	3,247	3,759	6,961	8,739	9,503	12,085	14,182	18,837	22,168	24,853	28,180	29,370	37,841
Payback from Cashflow	Total (67,644,973)	0	0	0	0	0	0	0	0	0	0	0	0	0	0	0
Voluntary Agency Advances																
Beginning Balance	Max 1,280,238	0	0	0	0	0	0	0	0	0	0	0	0	0	0	0
New Advance	Total 1,200,000	0	0	0	0	0	0	0	0	0	0	0	0	0	0	0
New Balance		0	0	0	0	0	0	0	0	0	0	0	0	0	0	0
Interest on Debt	8.5% 136,437	0	0	0	0	0	0	0	0	0	0	0	0	0	0	0
Payback from Cashflow	Total (1,336,422)	0	0	0	0	0	0	0	0	0	0	0	0	0	0	0
Reimbursement of Pre-DDA Infra & Proj. Costs	1,475,500	0	0	0	0	0	0	0	0	0	0	0	0	0	0	0
Total Proceeds Available for Distribution	41,725,250															
PARTNERSHIP PARTICIPATION																
Lennar/BVHP Share of Available Funds	40%	29,848,801	0	0	0	0	0	0	0	0	0	0	0	0	0	0
City Share of Available Funds	60%	30,916,274	0	0	0	0	0	0	0	0	0	0	0	0	0	0

Exhibit A
Monthly Cashflow and Revenue Participation
Phase 1 Development of the Hunters Point Shipyard

		Mar-05 Month 18	Apr-05 Month 19	May-05 Month 20	Jun-05 Month 21	Jul-05 Month 22	Aug-05 Month 23	Sep-05 Month 24	Oct-05 Month 25	Nov-05 Month 26	Dec-05 Month 27	Jan-06 Month 28	Feb-06 Month 29	Mar-06 Month 30	Apr-06 Month 31	May-06 Month 32	
	Total																
INCOME																	
Land Sales																	
Residential Land Sales																	
A'	106,252,259	0	0	0	0	0	0	0	0	0	0	0	0	0	0	8,146,275	
B'	18,670,218	0	0	0	0	0	0	0	0	0	0	0	0	0	0	0	
Commercial Land Sales	10,500,000	0	0	0	0	0	0	0	0	0	0	0	0	0	0	0	
Gross Land Sales	135,422,477	0	0	0	0	0	0	0	0	0	0	0	0	0	0	8,146,275	
Less Closing Costs	-1,354,225	0	0	0	0	0	0	0	0	0	0	0	0	0	0	-81,463	
Net Land Sales	134,068,252	0	0	0	0	0	0	0	0	0	0	0	0	0	0	8,064,812	
COSTS																	
Qualifying Project Costs																	
Qualified Pre Development Costs	25,000,000																
Qualified Pre Dev Costs In Excess of \$25M	0																
Infrastructure Construction Costs	74,887,777	1,711,148	1,948,480	4,845,915	5,190,376	5,301,185	4,700,474	4,355,307	6,655,232	2,889,388	51,969	51,969	44,680	47,042	598,534	1,321,769	
Indirect Costs	27,368,513	665,255	3,738,672	809,441	498,941	502,441	568,941	558,941	500,941	440,941	276,924	360,952	360,952	360,952	360,952	382,006	
Total Costs	127,256,290	2,376,403	5,687,152	5,655,356	5,689,316	5,803,626	5,269,415	4,914,247	7,156,172	3,330,328	328,893	412,921	405,632	407,994	959,486	1,703,775	
NET CASHFLOW BEFORE FINANCING																	
Net Cashflow	6,811,962	-2,376,403	-5,687,152	-5,655,356	-5,689,316	-5,803,626	-5,269,415	-4,914,247	-7,156,172	-3,330,328	-328,893	-412,921	-405,632	-407,994	-959,486	6,361,037	
FINANCING																	
Mello Roos Financing (Net)	40,800,000	0	0	10,984,522	361,325	54,890	1,711,148	1,948,480	4,845,915	5,190,376	5,301,185	482,818	719,340	0	0	0	
Assessments and LOC Costs	-2,321,664	0	-29,083	-29,083	-29,083	-29,083	-29,083	-29,083	-29,083	-29,083	-29,083	-29,083	-29,083	-29,083	-29,083	-25,466	
CASHFLOW PRIOR TO DEVELOPER SHORTFALL	45,290,298	-2,376,403	-5,716,235	5,300,083	-5,357,075	-5,777,819	-3,587,350	-2,994,850	-2,339,340	1,830,964	4,943,209	40,814	284,624	-437,077	-988,569	6,335,572	
Developer Shortfall Financing																	
Beginning Balance	Max	41,426,030	5,892,089	7,604,897	12,571,775	16,350,008	20,046,678	23,837,469	27,366,981	30,707,124	35,365,602	37,778,567	38,372,455	39,052,754	39,731,742	40,415,070	41,426,030
New Shortfall Advance	Total	65,626,138	1,672,638	4,914,860	3,691,401	3,583,691	3,652,427	3,365,277	3,152,071	4,448,078	2,171,058	336,603	420,630	416,339	417,730	742,403	0
New Balance		7,564,727	12,519,757	16,263,176	19,933,699	23,659,105	27,202,746	30,519,052	35,155,202	37,536,660	38,115,170	38,793,085	39,469,094	40,149,472	41,157,473	41,426,030	
Interest on Debt	8.5%	3,428,611	40,170	52,018	86,832	112,979	138,364	164,235	188,072	210,399	241,907	257,285	259,669	262,649	265,598	273,815	
Payback from Cashflow	Total	(67,644,973)	0	0	0	0	0	0	0	0	0	0	0	0	0	-6,170,348	
Voluntary Agency Advances																	
Beginning Balance	Max	1,280,238	0	0	0	100,000	467,375	837,352	1,209,950	1,218,521	1,227,152	1,235,844	1,244,598	1,253,414	1,262,292	1,271,234	1,280,238
New Advance	Total	1,200,000	0	0	100,000	366,667	366,667	366,667	0	0	0	0	0	0	0	0	0
New Balance		0	0	100,000	466,667	834,042	1,204,019	1,209,950	1,218,521	1,227,152	1,235,844	1,244,598	1,253,414	1,262,292	1,271,234	1,280,238	
Interest on Debt	8.5%	136,437	0	0	708	3,311	5,931	8,570	8,631	8,692	8,754	8,816	8,878	8,941	9,005	9,068	
Payback from Cashflow	Total	(1,336,422)	0	0	0	0	0	0	0	0	0	0	0	0	0	-190,690	
Reimbursement of Pre-DDA Infra & Proj. Costs		1,475,500	0	0	0	0	0	0	0	0	0	0	0	0	0	0	
Total Proceeds Available for Distribution		41,725,250															
PARTNERSHIP PARTICIPATION																	
Lennar/BVHP Share of Available Funds	40%	29,848,801	0	9,237,952	0	0	0	0	0	0	0	0	0	0	0	0	
City Share of Available Funds	60%	30,916,274	0	0	0	0	0	0	0	0	0	0	0	0	0	0	

Exhibit A
Monthly Cashflow and Revenue Participation
Phase 1 Development of the Hunters Point Shipyard

		Jun-06 Month 33	Jul-06 Month 34	Aug-06 Month 35	Sep-06 Month 36	Oct-06 Month 37	Nov-06 Month 38	Dec-06 Month 39	Jan-07 Month 40	Feb-07 Month 41	Mar-07 Month 42	Apr-07 Month 43	May-07 Month 44	Jun-07 Month 45	Jul-07 Month 46	Aug-07 Month 47	
Total																	
INCOME																	
Land Sales																	
Residential Land Sales																	
A'	106,252,259	0	20,137,147	0	0	0	16,856,882	0	0	0	0	0	0	0	61,111,955	0	
B'	18,670,218	0	0	0	0	0	0	0	0	0	0	0	0	0	0	0	
Commercial Land Sales	10,500,000	0	0	0	700,000	0	0	0	0	0	0	0	0	0	0	0	
Gross Land Sales	135,422,477	0	20,137,147	0	700,000	0	16,856,882	0	0	0	0	0	0	0	61,111,955	0	
Less Closing Costs	-1,354,225	0	-201,371	0	-7,000	0	-168,569	0	0	0	0	0	0	0	-611,120	0	
Net Land Sales	134,068,252	0	19,935,775	0	693,000	0	16,688,313	0	0	0	0	0	0	0	60,500,836	0	
COSTS																	
Qualifying Project Costs																	
Qualified Pre Development Costs	25,000,000																
Qualified Pre Dev Costs In Excess of \$25M	0																
Infrastructure Construction Costs	74,887,777	2,283,436	1,948,813	1,892,276	2,120,929	927,097	728,605	128,801	130,375	128,013	129,588	459,931	546,762	524,204	447,991	18,108	
Indirect Costs	27,368,513	360,952	412,996	360,952	362,761	360,952	404,519	314,547	306,214	306,214	306,214	306,214	306,214	306,214	330,824	172,880	
Total Costs	127,256,290	2,644,388	2,361,809	2,253,228	2,483,691	1,288,049	1,133,123	443,348	436,589	434,227	435,802	766,144	852,976	830,418	778,816	190,989	
NET CASHFLOW BEFORE FINANCING																	
Net Cashflow	6,811,962	-2,644,388	17,573,966	-2,253,228	-1,790,691	-1,288,049	15,555,190	-443,348	-436,589	-434,227	-435,802	-766,144	-852,976	-830,418	59,722,020	-190,989	
FINANCING																	
Mello Roos Financing (Net)	40,800,000	0	0	0	0	0	0	0	0	0	0	0	0	0	0	0	
Assessments and LOC Costs	-2,321,664	-25,466	-19,475	-19,475	-19,475	-174,956	-119,452	-119,452	-119,452	-119,452	-119,452	-119,452	-119,452	-119,452	0	0	
CASHFLOW PRIOR TO DEVELOPER SHORTFALL	45,290,298	-2,669,853	17,554,491	-2,272,703	-1,810,166	-1,463,006	15,435,738	-562,799	-566,041	-553,679	-555,253	-885,596	-972,427	-949,870	59,722,020	-190,989	
Developer Shortfall Financing																	
Beginning Balance	Max	41,426,030	35,529,498	37,446,617	20,575,652	22,070,096	23,007,961	24,089,668	8,926,589	9,436,415	9,938,834	10,439,863	10,941,820	11,638,254	12,385,808	13,120,082	0
New Shortfall Advance	Total	65,626,138	1,730,717	0	1,494,444	937,865	1,081,707	0	509,826	502,420	501,029	501,956	696,435	747,554	734,274	0	183,541
New Balance			37,260,215	37,446,617	22,070,096	23,007,961	24,089,668	24,089,668	9,436,415	9,938,834	10,439,863	10,941,820	11,638,254	12,385,808	13,120,082	13,120,082	183,541
Interest on Debt	8.5%	3,428,611	186,402	198,661	0	0	0	0	0	0	0	0	0	0	0	0	0
Payback from Cashflow	Total	(67,644,973)	0	-17,069,627	0	0	0	-15,163,079	0	0	0	0	0	0	0	-13,120,082	0
Voluntary Agency Advances																	
Beginning Balance	Max	1,280,238	1,098,617	1,106,399	609,896	614,216	618,567	622,948	235,250	236,917	238,595	240,285	241,987	243,701	245,427	247,166	1,751
New Advance	Total	1,200,000	0	0	0	0	0	0	0	0	0	0	0	0	0	0	0
New Balance			1,098,617	1,106,399	609,896	614,216	618,567	622,948	235,250	236,917	238,595	240,285	241,987	243,701	245,427	247,166	1,751
Interest on Debt	8.5%	136,437	7,782	7,837	4,320	4,351	4,382	4,413	1,666	1,678	1,690	1,702	1,714	1,726	1,738	1,751	12
Payback from Cashflow	Total	(1,336,422)	0	-504,340	0	0	0	-392,111	0	0	0	0	0	0	0	-247,166	0
Reimbursement of Pre-DDA Infra & Proj. Costs		1,475,500	0	0	0	0	0	0	0	0	0	0	0	0	0	1,475,500	0
Total Proceeds Available for Distribution		41,725,250															
PARTNERSHIP PARTICIPATION																	
Lennar/BVHP Share of Available Funds	40%	29,848,801	0	0	0	0	0	0	0	0	0	0	0	0	0	17,723,467	0
City Share of Available Funds	60%	30,916,274	0	0	0	0	0	0	0	0	0	0	0	0	0	26,585,201	0

Exhibit A
Monthly Cashflow and Revenue Participation
Phase 1 Development of the Hunters Point Shipyard

		Sep-07 Month 48	Oct-07 Month 49	Nov-07 Month 50	Dec-07 Month 51	Jan-08 Month 52	Feb-08 Month 53	Mar-08 Month 54	Apr-08 Month 55	May-08 Month 56	Jun-08 Month 57	Jul-08 Month 58	Aug-08 Month 59	Sep-08 Month 60	Oct-08 Month 61	Nov-08 Month 62	
	Total																
INCOME																	
Land Sales																	
Residential Land Sales																	
A'	106,252,259	0	0	0	0	0	0	0	0	0	0	0	0	0	0	0	
B'	18,670,218	0	0	0	0	0	0	0	0	0	0	0	0	0	0	0	
<u>Commercial Land Sales</u>	<u>10,500,000</u>	<u>0</u>	<u>0</u>	<u>0</u>	<u>0</u>	<u>0</u>	<u>0</u>	<u>0</u>	<u>0</u>	<u>0</u>	<u>0</u>	<u>0</u>	<u>0</u>	<u>0</u>	<u>0</u>	<u>0</u>	
Gross Land Sales	135,422,477	0	0	0	0	0	0	0	0	0	0	0	0	0	0	0	
Less Closing Costs	-1,354,225	0	0	0	0	0	0	0	0	0	0	0	0	0	0	0	
Net Land Sales	134,068,252	0	0	0	0	0	0	0	0	0	0	0	0	0	0	0	
COSTS																	
Qualifying Project Costs																	
Qualified Pre Development Costs	25,000,000																
Qualified Pre Dev Costs In Excess of \$25M	0																
Infrastructure Construction Costs	74,887,777	15,746	18,108	17,321	16,534	279	0	0	0	0	0	0	0	0	316,279	316,279	
Indirect Costs	27,368,513	172,880	172,880	172,880	203,730	203,730	203,730	203,730	195,396	195,396	195,396	195,396	195,396	195,396	195,396	195,396	
Total Costs	127,256,290	188,627	190,989	190,201	220,263	204,008	203,730	203,730	195,396	195,396	195,396	195,396	195,396	195,396	511,675	511,675	
NET CASHFLOW BEFORE FINANCING																	
Net Cashflow	6,811,962	-188,627	-190,989	-190,201	-220,263	-204,008	-203,730	-203,730	-195,396	-195,396	-195,396	-195,396	-195,396	-195,396	-511,675	-511,675	
FINANCING																	
Mello Roos Financing (Net)	40,800,000	0	0	0	0	0	0	0	0	0	0	0	0	0	0	0	
Assessments and LOC Costs	-2,321,664	0	0	0	0	0	0	0	0	0	0	0	0	0	0	0	
CASHFLOW PRIOR TO DEVELOPER SHORTFALL	45,290,298	-188,627	-190,989	-190,201	-220,263	-204,008	-203,730	-203,730	-195,396	-195,396	-195,396	-195,396	-195,396	-195,396	-511,675	-511,675	
Developer Shortfall Financing																	
Beginning Balance	Max	41,426,030	183,541	365,692	549,233	732,310	945,774	1,149,667	1,353,397	1,557,127	1,752,523	1,947,919	2,143,316	2,338,712	2,534,108	2,729,505	3,111,100
New Shortfall Advance	Total	65,626,138	182,151	183,541	183,078	213,463	203,894	203,730	203,730	195,396	195,396	195,396	195,396	195,396	195,396	381,596	381,596
New Balance			365,692	549,233	732,310	945,774	1,149,667	1,353,397	1,557,127	1,752,523	1,947,919	2,143,316	2,338,712	2,534,108	2,729,505	3,111,100	3,492,696
Interest on Debt	8.5%	3,428,611	0	0	0	0	0	0	0	0	0	0	0	0	0	0	0
Payback from Cashflow	Total	(67,644,973)	0	0	0	0	0	0	0	0	0	0	0	0	0	0	0
Voluntary Agency Advances																	
Beginning Balance	Max	1,280,238	1,763	1,776	1,788	1,801	1,814	1,826	1,839	1,852	1,866	1,879	1,892	1,906	1,904	1,917	1,931
New Advance	Total	1,200,000	0	0	0	0	0	0	0	0	0	0	0	0	0	0	0
New Balance			1,763	1,776	1,788	1,801	1,814	1,826	1,839	1,852	1,866	1,879	1,892	1,906	1,904	1,917	1,931
Interest on Debt	8.5%	136,437	12	13	13	13	13	13	13	13	13	13	13	13	13	14	14
Payback from Cashflow	Total	(1,336,422)	0	0	0	0	0	0	0	0	0	0	0	-15	0	0	0
Reimbursement of Pre-DDA Infra & Proj. Costs		1,475,500	0	0	0	0	0	0	0	0	0	0	0	0	0	0	0
Total Proceeds Available for Distribution		41,725,250															
PARTNERSHIP PARTICIPATION																	
Lennar/BVHP Share of Available Funds	40%	29,848,801	0	0	0	0	0	0	0	0	0	0	0	0	0	0	0
City Share of Available Funds	60%	30,916,274	0	0	0	0	0	0	0	0	0	0	0	0	0	0	0

Exhibit B
Qualified Predevelopment Costs
Hunters Point Shipyard
March 31, 2005

Cost Category	Qualified Predevelopment Costs
Environmental	\$2,650,768
PDC	\$2,635,684
Navy Conveyance	\$1,567,516
Development Transaction	\$2,956,240
SFRA/City Administration Costs	\$6,500,000
<u>Infrastructure</u>	
<i>AB to 10%</i>	\$1,737,473
<i>A'B' to 10 - 35%/L.U. Modeling</i>	\$0
<i>LU Modeling</i>	\$390,494
<i>A' to 35% - 100% (incl Peer Review)</i>	\$0
<i>B' to 35%-100%</i>	\$0
SUBTOTAL	\$2,127,966
Planning & Entitlements	\$1,255,066
Fees/Permits	\$15,143
Subdivision	\$205,742
Miscellaneous Costs	\$85,874
Total	\$20,000,000

Exhibit C
Qualified Pre-Agreement Costs
Hunters Point Shipyard
March 31, 2005

Cost Category	Qualified Pre-Agreement Costs
Infrastructure	
<i>A'B' to 10 - 35%/L.U. Modeling</i>	\$1,102,309
<i>A' to 35% - 100% (incl Peer Review)</i>	\$24,276
SUBTOTAL	<u>\$1,126,585</u>
Planning & Entitlements	\$61,784
Subdivision	\$57,302
Miscellaneous Legal Costs	\$229,830
Total	\$1,475,500

EXHIBIT D

Agency Land Return and Developer Equity Return Formulas and Examples and Methodology Used in Calculating Developer's Cost of Borrowing.

The Agency Land Return for each month is calculated using the formula: (prior month's undistributed Land Value less any distribution of Net Revenue for the current month + prior month's undistributed Agency Land Return) $\times ((1+0.11)^{(1/12)})-1$. An example of the calculation of Agency Land Return is set forth below:

	Month 1	Month 2	Month 3	Month 4
Undistributed "Land Value" and "Agency Land Return"	30,000,000.00	30,262,037.81	30,526,364.42	24,740,592.25
Distributions of "Net Revenues" to Agency	-	-	6,000,000.00	-
Monthly Return Rate	0.008735	0.008735	0.008735	0.008735
"Agency Land Return"	262,037.81	264,326.61	214,227.83	216,099.02

The Developer Equity Return for each month is calculated using the formula: (prior month's undistributed Developer's Outstanding Qualified Predevelopment Costs less any distribution of Net Revenue for the current month + prior months undistributed Developer Equity Return) $\times ((1+0.25)^{(1/12)})-1$. An example of the calculation of Developer Equity Return is set forth below:

	Month 1	Month 2	Month 3	Month 4
Undistributed Developer's Outstanding Qualified Predevelopment Costs	15,000,000.00	15,281,538.98	15,568,362.23	11,785,491.89
Distributions of "Net Revenues" to Developer	-	-	4,000,000.00	-
Monthly Return Rate	0.018769	0.018769	0.018769	0.018769
"Developer Equity Return"	281,538.98	286,823.26	217,129.66	221,205.02

ATTACHMENT 26

OPTION: ALTERNATIVE FINANCING AND REVENUE SHARING PLAN WITH ACCELERATED COMPENSATION FOR LAND VALUE

This Option: Alternative Financing and Revenue Sharing Plan With Accelerated Compensation for Land Value (“Alternative Plan”) is attached to and made a part of the Disposition and Development Agreement (the “Agreement”) for Hunters Point, Phase 1. Capitalized terms not defined in this Alternative Plan have the meanings given to them in the Agreement. References to Sections are to Sections of this Attachment 26 unless otherwise specified. References to Attachments includes amendments thereto. This Alternative Plan applies only to the Project Site. The Agency Parcels, comprising the Agency Housing Parcels, Community Facility Parcels and Open Space, will continue to be held by the Agency and are not subject to the option set forth in this Alternative Plan.

Section 1. Definitions.

Affiliate means a Person in which Developer or a Vertical Developer, as the case may be, directly or indirectly owns and/or controls (a) twenty-five percent (25%) or more (or if such Person is not publicly traded, fifty percent (50%) or more) of each class of equity interests (including rights to acquire such interests), or (b) twenty-five percent (25%) or more (or if such Person is not publicly traded, fifty percent (50%) or more) of each class of interests that have a right to nominate, vote for or otherwise select the members of the board or other governing body that directs or causes the direction of substantially all of the management and policies of that Person.

Affiliate Lot(s) means the parcels over which Affiliates of Developer have certain rights of refusal in accordance with Section 15.3 of the Agreement, which are designated as Affiliate Lots on the map attached to the Agreement as Attachment 2, *i.e.*, all Lots other than the Community Builder Lots.

Agency Land Return means the amount that results in an eleven percent (11%) per annum internal rate of return on the Land Value beginning from the Effective Date, calculated pursuant to the formula set forth in the Financing and Revenue Sharing Plan attached to the Agreement as Attachment 25.

Agreement has the meaning set forth in the Preamble.

Alternative Plan has the meaning set forth in the Preamble.

Alternative Plan Consideration means the compensation to be paid by Developer to the Agency in consideration for substituting this Alternative Plan for the Plan. The Alternative Plan Consideration includes the Initial Payment and the Profit Participation.

Approved Budget means the Preliminary Budget and any subsequent Budgets approved by the Agency pursuant to the process described in Section 5.

Approved Expenses means Developer's Hard Costs and Soft Costs (as defined in Attachment 25), and the Agency's Costs (as defined in the Agreement), expended in developing Phase 1 that are incurred after the Effective Date of the Agreement and included in an Approved Budget. Unless the Agency agrees otherwise in writing, Approved Expenses will exclude (i) costs that are not included in an Approved Budget, (ii) costs incurred before the Effective Date of the Agreement, (iii) Qualified Predevelopment Costs, (iv) Qualified Pre-Agreement Costs, (v) any amounts that cannot be reasonably verified through statements and invoices and (vi) any reimbursement for Developer's, or any Developer Affiliate's, overhead or personnel expenses, or payments to Developer or any Developer Affiliate; provided that, the Agency will not unreasonably withhold its approval of payments to Developer or any Developer Affiliate specifically identified in any proposed Budget for which Developer has provided written evidence (reasonably satisfactory to the Agency) that the proposed payments are not related to overhead or personnel expenses and do not exceed amounts that would be payable to non-related third parties in arms-length transactions for similar services within the City.

Bond Proceeds means the proceeds of any Mello-Roos Bonds issued for the development of Phase 1.

Bond Proceeds Account means an interest-bearing account for all Net Bond Proceeds.

Broker means a licensed real estate broker with at least ten (10) years of experience in representing sellers of the kind of real property in the City that he or she is called upon to list under this Attachment 26.

Built-Out Lots means Lots upon which Complete Construction of Vertical Improvements has been achieved so that the Lots can be occupied for their intended purpose.

Community Builder means a Qualified Community Builder as set forth in the Additional Business, Employment, Construction Assistance/Opportunities and Community Benefits Program attached as Exhibit B to Attachment 24.

Community Builder Purchase and Sale Agreement has the meaning set forth in Section 2.4(b).

Complete Construction means that (a) a specified scope of work has been completed in accordance with mutually approved plans and specifications; (b) public agencies with jurisdiction have issued all permits, licenses, approvals, certificates of occupancy and other sign-offs required for the contemplated use and occupancy of the scope of work; (c) the site has been cleaned and all equipment, tools and other construction materials and debris have been removed; (d) all bills for the scope of work have been paid, any surety has consented to final payment, no mechanics' liens have been recorded and the period for recording mechanics' liens has expired; and (e) all as-built plans and warranties, guaranties, operating manuals, operations and maintenance data, certificates of completed operations or other insurance, and all other close-out items required under the pertinent construction contract, have been provided.

Developer/Community Builder Venture has the meaning set forth in Section 2.4(b).

Effective Date means the Effective Date of the Agreement.

Exercise Notice has the meaning set forth in Section 2.1.

Fair Market Value means the cash purchase price that a willing buyer would pay to a willing seller at the time of sale, neither being under a compulsion to buy or sell, and both being fully aware of relevant facts, and without linking the cash price to any other consideration offered by Developer. The Fair Market Value will consider the Lots as finished Lots (with views, if applicable) entitled pursuant to the Vertical DDA, located in a master planned community in an urban center and improved with extensive public and private infrastructure, including without limitation the Third Street Light Rail Project. The Parties acknowledge that lots at Mission Bay, to the extent similar in terms of product type, size, views, amenities and the like, may provide useful comparables, depending on the proximity in time between the appraisal of the Lot and the relevant Mission Bay transaction.

Final Accounting has the meaning set forth in Section 2.3(c).

Finished Lots means Lots that have been subdivided, and as to which Complete Construction of all Infrastructure required for the Vertical Development of the Lot has been achieved.

Finished Lot Costs means (a) for each Affiliate Lot, and for each Community Builder Lot developed by a Developer/Community Builder Venture, the Fair Market Value of such Lot at the time of transfer to the Vertical Developer, determined by a mutually acceptable process to be determined by Developer and the Agency prior to the Closing Date and (b) for each Community Builder Lot sold to a Community Builder or a Third-Party, the net purchase price paid to Developer for such Lot.

Finished Lot Gross Revenues means all cash, notes or other payments or credits of any kind arising from disposition of Finished Lots. Mandatory Developer Advances, Voluntary Agency Advances and Bond Proceeds are not included in Finished Lot Gross Revenues.

Finished Lot Proceeds Account means an interest-bearing account for all Finished Lot Gross Revenues.

Horizontal Improvements or Infrastructure means the works of improvement described in the Infrastructure Plan attached to the Agreement as Attachment 9.

Initial Payment has the meaning set forth in Section 2.2.

Interim Statement has the meaning set forth in Section 2.3(a).

Land Value means the amount of Thirty Million Dollars (\$30,000,000.00) treated as if expended on the Effective Date.

Marketing Period has the meaning set forth in Section 2.4(c).

Mello-Roos Bonds means tax-exempt bonds issued under the Mello-Roos Community Facilities Act of 1982, California Government Code Sections 53311 *et seq.*

Mello-Roos Reserve has the meaning set forth in Section 4.3.

Minimum Purchase Price means the price for each Lot set forth on a schedule to the Preliminary Budget and Project Pro Forma attached as Exhibit A to Attachment 25, which Exhibit is incorporated in this Attachment 26 by reference. The Minimum Purchase Price assumes a full cash purchase price to seller.

Multi Unit/Commercial Facilities are defined in the definition of Vertical Improvement Gross Revenues.

Net Bond Proceeds has the meaning set forth in Section 3.2.

Option Period has the meaning set forth in Section 2.1.

Party means either the Agency or Developer; **Parties** mean the Agency and Developer, collectively.

Person means any natural person, corporation, firm, partnership, association, joint venture, governmental or political subdivision or agency or any similar entity.

Plan has the meaning set forth in the Financing and Revenue Sharing Plan set forth in Attachment 25 to the Agreement.

Preliminary Budget means the Preliminary Budget and Project Pro Forma attached as Exhibit A to Attachment 25, which Exhibit is incorporated in this Attachment 26 by reference.

Profit Participation has the meaning set forth in Section 2.3.

Project Site means Parcels A-1 and B-1 as more particularly described in Attachment 1 to the Agreement, and as shown on the map attached as Attachment 2 to the Agreement. The Project Site does not include the Agency Parcels, which comprise the Agency Housing Parcels, Community Facility Parcels and Open Space.

Public Facility Approved Expenses means the portion and types of Approved Expenses that are eligible for reimbursement out of Bond Proceeds pursuant to applicable IRS rules and regulations, consistent with their tax-exempt status and customary underwriting standards related to the issuance of the Mello-Roos Bonds.

Public Facility Predevelopment Costs means the portion and types of Qualified Predevelopment Costs described on Exhibit B to Attachment 25, which Exhibit is incorporated in this Attachment 26 by reference, that are eligible for reimbursement out of Bond Proceeds under applicable IRS rules and regulations, consistent with their tax-exempt status and customary underwriting standards related to the issuance of the Mello-Roos Bonds, up to a maximum amount not to exceed Ten Million Dollars (\$10,000,000.00).

Public Facility Pre-Agreement Costs means the portion and types of Qualified Pre-Agreement Costs described on Exhibit C to Attachment 25, which Exhibit is incorporated in this Attachment 26 by reference, that are eligible for reimbursement out of Bond Proceeds under

applicable IRS rules and regulations, consistent with their tax-exempt status and customary underwriting standards related to the issuance of the Mello-Roos Bonds.

Qualified Buyer means a third-party buyer who is not an Affiliate of Developer or a Community Builder and who is reasonably creditworthy given the obligations it is assuming, and the principals of which have at least five (5) years of experience in developing the kind of housing or commercial product to be developed on the Lot the Qualified Buyer is seeking to purchase. Reasonable creditworthiness will be assumed if the Qualified Buyer qualifies for a loan consistent with the mortgage provisions in the Vertical DDA on the Lot the Qualified Buyer is seeking to purchase.

Qualified Predevelopment Costs means the costs described on Exhibit B attached to Attachment 25, which Exhibit is incorporated in this Attachment 26 by reference, plus interest at the rate of twelve percent (12%) per annum simple interest from the date the Costs are paid by Developer until the Effective Date of the Agreement (the "Roll-Up Interest"). The Qualified Predevelopment Costs shall not exceed Twenty Million Dollars (\$20,000,000.00) and the Roll-Up Interest shall not exceed Five Million Dollars (\$5,000,000.00), in a total aggregate not to exceed Twenty-Five Million Dollars (\$25,000,000.00).

Qualified Pre-Agreement Costs means the costs described on Exhibit C attached to Attachment 25, which Exhibit is incorporated in this Attachment 26 by reference, in the amount of One Million Four Hundred Seventy-Four Thousand Five Hundred Dollars (\$1,474,500.00). Qualified Pre-Agreement Project costs will not accrue interest.

Real Estate Brokerage Agreement has the meaning set forth in Section 2.4(c).

Records has the meaning set forth in Section 5.6.

Third-Party Purchase and Sale Agreement has the meaning set forth in Section 2.4(c).

Transfer and its variants mean to sell, assign, convey, lease, sublease, mortgage, hypothecate or otherwise alienate, excluding therefrom any grant of occupancy rights, such as space leases, for improvements within the Redevelopment Area, to the extent permitted under the Interim Lease.

Unit means a single Lot, condominium or other unit of the Project Site that has been Built-Out and can be separately Transferred.

Vertical Developer means Affiliates of Developer, Developer/Community Builder Ventures and Community Builders, and any other Person, as the case may be, acquiring Lots for the development and construction of Vertical Improvements in accordance with Section 2.4.

Vertical Developer DDA means the form of Disposition and Development Agreement for the Vertical Development incorporating the outline of terms and conditions included in Attachment 27, as modified to reflect the Lot and Vertical Development in question.

Vertical Developer Direct Costs means the out-of-pocket costs actually incurred and paid by Vertical Developer to third-party providers for services and materials for construction of

the Units and the Multi-Unit/Commercial Facilities, comprising fees for inspections, building permits and other permits, the fees of engineers, surveyors, architects and other design consultants, payments to contractors and suppliers for construction, furnishings, fixtures and equipment. Unless the Agency agrees otherwise in writing, Vertical Developer Direct Costs will exclude reimbursement for Vertical Developer's overhead or personnel expenses, or payment to any Vertical Developer Affiliate; provided that, the Agency will not unreasonably withhold its approval to payment to Vertical Developer or any Vertical Developer Affiliate for which Vertical Developer has provided written evidence (reasonably satisfactory to the Agency) that the proposed payments are not related to overhead or personnel expenses and do not exceed amounts that would be payable to non-related third parties in arms-length transactions for similar services within the City. Vertical Developer Direct Costs will also exclude any amounts that cannot be reasonably verified through statements and invoices, as well as Finished Lot Costs and Vertical Developer Indirect Costs. The amounts of all Vertical Developer Direct Costs claimed are subject to confirmation by an inspection and independent audit performed by an auditor selected by the Agency, in accordance with Section 5.7.

Vertical Developer Indirect Costs means the out-of-pocket costs actually incurred and paid by Vertical Developer to third-party providers for constructing, marketing and selling the Units and the Multi-Unit/Commercial Facilities, and comprising on-site general conditions and personnel costs, real property taxes and assessments for the Lots, insurance expenses, construction (not acquisition) financing fees and interest, sales and marketing expenses, Department of Real Estate processing costs, homeowners' association and management costs and customary closing costs incurred in connection with sales of Units and the Multi-Unit/Commercial Facilities to the public. Unless the Agency agrees otherwise in writing, Vertical Developer Indirect Costs will exclude reimbursement for Vertical Developer's overhead or personnel expenses, or payment to any Vertical Developer Affiliate; provided that, the Agency will not unreasonably withhold its approval to payment to Vertical Developer or any Vertical Developer Affiliate for which Vertical Developer has provided written evidence (reasonably satisfactory to the Agency) that the proposed payments are not related to overhead or personnel expenses and do not exceed amounts that would be payable to non-related third parties in arms-length transactions for similar services within the City. Vertical Developer Indirect Costs will also exclude any amounts that cannot be reasonably verified through statements and invoices, as well as Finished Lots Costs and Vertical Developer Direct Costs. The amounts of all Vertical Developer Indirect Costs claimed are subject to confirmation by an inspection and independent audit performed by an auditor selected by the Agency, in accordance with Section 5. The Parties agree that irrespective of the Vertical Developer Indirect Costs actually incurred, the amount designated as Vertical Developer Indirect Costs for purposes of determining Net Profit and the Profit Participation shall not exceed twenty percent (20%) of Vertical Developer Direct Costs.

Vertical Developer Profit means ten percent (10%) of the total Vertical Developer Direct Costs and Vertical Developer Indirect Costs.

Vertical Improvements has the meaning set forth in the Agreement.

Vertical Improvement Gross Revenues means all sales proceeds, revenues and other consideration from the sale or other disposition (including proceeds of insurance, condemnation

or otherwise) of the Units, including without limitation the base sales price of the Units, Lot premiums and option and upgrade revenue, and of the apartment complexes, commercial facilities and other Vertical Improvements built on Phase 1 that are not Units (the "Multi-Unit/Commercial Facilities").

Vertical Improvements Net Profit means Vertical Improvements Gross Revenues less the (a) Finished Lot Costs, (b) Vertical Developer Direct Costs, (c) Vertical Developer Indirect Costs and (d) Vertical Developer Profit.

Section 2. Election of Alternative Plan and Alternative Plan Consideration.

2.1 Election of Alternative Plan. Developer may exercise its right to proceed under this Alternative Plan rather than under the Plan by delivering written notice of its exercise to the Agency (the "Exercise Notice"). In order to be effective, (a) the Agency must receive the Exercise Notice on or before the earlier of (i) ten (10) months after the Close of Escrow for the conveyance of Parcel A-1 from the Agency to Developer or (ii) the transfer of the first Lot in Parcel A-1 (the "Option Period") to a Vertical Developer and (b) there shall be no Event of Default (or event which with notice and/or the passage of time may become an Event of Default) by Developer under the Agreement, both as of the date the Exercise Notice, and as of the date the Initial Payment, is received by the Agency. If Developer timely delivers the Exercise Notice, then it shall deliver the Initial Payment within the period set forth in Section 2.2. If Developer fails to timely deliver the Initial Payment, then among the Agency's other remedies at law or in equity, the Agency may consider Developer's Exercise Notice to be null and void. If Developer timely delivers both the Exercise Notice and the Initial Payment, then as of the date of the Initial Payment, the Alternative Plan shall become effective and continue in full force and effect, and the Plan, and Section 15 of the Agreement, shall become null and void, except that the Exhibits to the Plan shall be incorporated into and made a part of the Alternative Plan to the extent specified in this Attachment 26. If Developer does not timely deliver the Exercise Notice, then Developer's right to exercise its option to proceed under the Alternative Plan will automatically expire as of the last day of the Option Period. If Developer timely delivers the Exercise Notice, but fails to timely deliver the Initial Payment (and the Agency thereby elects to consider the Developer's Exercise Notice null and void), then the Alternative Plan shall automatically expire as of the last day delivery of the Initial Payment could be made and Developer shall have no right thereafter to elect to pay the Agency in accordance with the Alternative Plan. If either of the immediately preceding two sentences apply, then this Attachment 26 shall become null and void and neither Party will have any rights or obligations hereunder, and the Plan and Section 15 of the Agreement shall continue in full force and effect.

2.2 Initial Payment. If Developer has timely delivered the Exercise Notice, but Closing on Parcel A-1 has not yet occurred, then Closing on Parcel A-1 shall take place in the time and manner set forth in Section 6 of the Agreement, except at least one (1) Business Day before such Closing Developer shall deposit in Escrow (by wire transfer of federal funds), (a) the Land Value of Thirty Million Dollars (\$30,000,000.00) plus (b) the Agency Land Return from and including the Effective Date to and including the date of payment (collectively, the "Initial Payment") with instructions to deliver the same to the Agency at Closing. If the Closing on Parcel A-1 has occurred, then within ten (10) days after delivery of the Exercise Notice, Developer shall deliver the Initial Payment to the Agency (by wire transfer of federal funds) to:

Beneficiary: San Francisco Redevelopment Agency
Beneficiary Account No.: 0004-224-361
Bank: Union Bank of California
Bank Address: San Francisco, CA.
Bank ABA#: 122-000-496

or to such other wire transfer address as the Agency may instruct. The Agency shall be entitled to the entire Initial Payment even if there has been no Close of Escrow for the conveyance of Parcel B-1 from the Agency to Developer as of the expiration of the Option Period. In that event, the Agency shall (i) use commercially reasonable efforts to acquire Parcel B-1 from the Navy as soon as reasonably practicable and (ii) transfer Parcel B-1 to Developer for no additional consideration as soon as reasonably practicable after the Agency acquires Parcel B-1.

2.3 Profit Participation. As further Alternative Plan Consideration, the Agency shall receive fifty percent (50%) of the Vertical Improvements Net Profit flowing from the sale or other disposition of the Built-Out Lots (the "Profit Participation"). In order to maximize the Profit Participation, the Vertical DDA shall provide that, unless the Agency and Vertical Developer mutually agree otherwise (each acting in its sole and absolute discretion), Vertical Developer will use commercially reasonable efforts to sell all (a) Units as soon as reasonably practicable after they become Built-Out Lots and (b) Multi-Tenant/Commercial Facilities as soon as they achieve rent stabilization after they become Built-Out Lots. Unless the Agency and Vertical Developer mutually agree otherwise (each acting in its sole and absolute discretion), the sales will be arms-length transactions to third parties unrelated to the Agency or to Developer or Vertical Developer, on the basis of full cash to seller, without any seller carry-back financing or non-cash consideration. The Profit Participation shall be paid as follows:

(a) **Interim Statements; Payment of Estimated Profit Participation.** The final amount of Profit Participation shall be determined on an overall Phase basis, but there shall be an interim calculation and payment of Profit Participation at each Unit or Multi-Unit/Commercial Facility Closing. The Vertical Developer shall prepare and submit to the Agency for the Agency's approval, at least fifteen (15) days before the scheduled date of the first such closing within any Phase, a written statement for such Phase which: (i) identifies the Units or Multi-Unit/Commercial Facilities within the Phase that are being offered for sale; (ii) sets forth in reasonable detail an accounting of the allocable Finished Lot Cost, Vertical Developer Direct Costs, Vertical Developer Indirect Costs and Vertical Developer Profit for each of the Units or Multi-Unit/Commercial Facilities in the Phase; and (iii) calculates the estimated Net Profit and Profit Participation for each Unit or Multi-Unit/Commercial Facility (the "Interim Statement"). Upon approval by the Agency, the Parties shall submit the Interim Statement to the escrow company with instructions to make payment to the Agency of the applicable estimated Profit Participation reflected in the approved Interim Statement at each Unit or Multi-Unit/Commercial Facility closing. The Profit Participations paid to the Agency at the closings are installments of the estimated total Profit Participation payable to the Agency. The actual final amount of the Profit Participation shall be determined in accordance with Section 2.3(c) below.

(b) **Periodic Reconciliations.** The Vertical Developer shall maintain accurate books and records in auditable form with respect to all items of Finished Lot Costs, Vertical Developer Direct Costs, Vertical Developer Indirect Costs and Vertical Developer Profit, and

shall prepare and submit to the Agency for the Agency's approval a reconciliation of such items against the aggregate installments of Profit Participation paid for all Units and Multi-Unit/Commercial Facilities sold to date in the applicable Phase on a cumulative basis after the sale of each group of twenty (20) Units or every six (6) months, whichever occurs first. If any such reconciliation shows that the Agency has received less than it should have received, the Vertical Developer shall pay the deficiency to the Agency within thirty (30) days after the determination, together with interest thereon at the Advance Interest Rate. If the reconciliation shows that the Agency has received more than it should have received, the amount of the overpayment, together with interest thereon at the Advance Interest Rate, shall be credited against future estimated payments of Profit Participation to the Agency.

(c) **Final Determination and Payment of Profit Participation.** Within ninety (90) days after the Closing for the last Unit or Multi-Unit/Commercial Facility in a Phase, the Vertical Developer shall prepare and submit to the Agency for the Agency's approval a complete accounting of all items of Finished Lot Costs, Vertical Developer Direct Costs, Vertical Developer Indirect Costs and Vertical Developer Profit for the Phase, and computations setting forth, on an aggregate basis, the total Net Profit and Profit Participation for the Phase (the "Final Accounting"). If the Final Accounting for the Phase shows that the Agency has received installments of the Profit Participation that, in the aggregate, are less than the total amount owed, the Vertical Developer shall pay the deficiency to the Agency within thirty (30) days after approval of the Final Accounting, together with interest thereon at the Advance Interest Rate. If the Final Accounting shows that the Agency has received installments of the Profit Participation that, in the aggregate, exceed the total amount owed, the Agency will pay the overpayment to the Vertical Developer within thirty (30) days after approval of the Final Accounting, together with interest thereon at the Advance Interest Rate.

2.4 Transfer Restrictions.

(a) **Restrictions on Transfer of Finished Lots.** If Developer exercises its option to proceed under the Alternative Plan, then Finished Lots comprising (i) Affiliate Lots may be Transferred only to Developer Affiliates, each of whom will be responsible to achieve Complete Construction of all Vertical Improvements on the Finished Lot(s) transferred to it and (ii) Community Builder Lots may be Transferred only in accordance with Section 2.4(b) below.

(b) Community Builder Lots.

(1) If the Lot to be sold is a Community Builder Lot and if Developer and a Community Builder have entered into a joint venture or other arrangement consistent with Section 2.4(d) (a "Developer/Community Builder Venture") prior to the date the Lot is first offered for transfer, then the Developer/Community Builder Venture will have the same rights, and be subject to the same obligations, in connection with the transfer of a Community Builder Lot as an Affiliate of Developer has in connection with an Affiliate Lot. If the Lot to be sold is a Community Builder Lot, and if Developer and a Community Builder have not entered into a joint venture or other arrangement consistent with Section 2.4(d), then the Community Builder Lot will be sold under this Section 2.4(b)(2)-(4).

(2) Developer will market the Community Builder Lots to Community Builders consistent with Section 2.4(d). If a Community Builder offers to buy the Community Builder Lot “as is, where is” for at least the Minimum Purchase Price, payable full cash to seller at closing, then Developer will enter into a purchase and sale agreement with the Community Builder in a form mutually acceptable to the Agency, Developer and the Community Builder (the “Community Builder Purchase and Sale Agreement”).

(3) If (i) no Community Builder offers to buy the Community Builder Lot during the Marketing Period for at least the Minimum Purchase Price, (ii) the Parties and the Community Builder cannot agree on the form of Community Builder Purchase and Sale Agreement or (iii) any such Community Builder defaults under the Community Builder Purchase and Sale Agreement, then the Community Builder Lot in question will not be sold to the specified Community Builder and instead will be available for purchase by another Community Builder under this Section 2.4(b); provided, however, that, if either Party so elects within ten (10) days after notice of a default by the Community Builder to pursue specific performance against the Community Builder, then Developer will initiate and diligently prosecute an action for specific performance. The initiating Party will bear the reasonable cost of the specific performance action if it is unsuccessful, but if it is successful, then both Parties will bear the cost in equal shares.

(4) Notwithstanding the above, if any Community Builder Lot has been subject to the sales procedures referenced in this Section 2.4(b) twice, and has still not been sold to a Community Builder, then the Agency may elect to purchase the Community Builder Lot by delivering written notice to Developer within one hundred eighty (180) days after the agreement with the second Community Builder has formally terminated (as evidenced by written notice from Developer to the Agency, which notice will include reasonable documentation supporting the termination date). If the Agency does so elect, then the Agency may purchase such Lot on substantially the same terms and conditions as in the agreement with the second Community Builder, with reasonable adjustments to reflect the Agency’s status as buyer and the extended time frame. If the Lot has been offered to Community Builders under this Section 2.4 twice, and no agreement has been entered into with a Community Builder, then the one hundred eighty (180) day period for the Agency’s option will be measured from the end of the Marketing Period for the second offer to Community Builders, and the terms of the option will be equivalent to the terms offered to Community Builders on the second round, with reasonable adjustments to reflect the Agency’s status as buyer and the extended time frame, or on other terms mutually satisfactory to Developer and the Agency. If the Agency does not elect to purchase the Lot within the one hundred eighty (180) day period, then the Parties will initiate a Third-Party Sale under Section 2.4(c).

(c) Third-Party Sale of Community Builder Lots.

(1) If the Parties are proceeding under this Section 2.4(c), they will promptly initiate a marketing program for the Community Builder Lot in question through a Broker mutually acceptable to both of them. If the Parties cannot agree on a mutually acceptable Broker within ten (10) days after the receipt by either Party of a written proposal of a Broker by the other Party, then the Broker will be the first available Broker from a list of at least five (5) pre-approved Brokers to be agreed upon by the Agency and Developer as a condition to Closing,

starting with the first named Broker and continuing to cycle through the list as Brokers are required, provided that no Broker shall represent Developer in more than three (3) consecutive sales of Community Builder Lots. If none of the Brokers listed is able or willing to serve, then within ten (10) days after either Party accurately informs the other in writing that no listed Broker is able or willing to serve, each Party will prepare a list of three (3) Brokers acceptable to that Party and exchange its list with the other Party. Within ten (10) days after receipt of the other Party's list, each Party will strike two (2) names and return the modified list. The Broker will be one (1) of the two (2) names remaining on the list, with each Party's final selection to be chosen in turn. The initial selection will be determined by a coin toss. Developer will retain the Broker selected through a listing agreement in a form mutually acceptable to the Agency, Developer and the Broker (the "Real Estate Brokerage Agreement"). The "Marketing Period" during which the Lot will be actively marketed will be six (6) months.

(2) If during the Marketing Period a Qualified Buyer offers to buy the Lot "as is," "where is" for at least the Minimum Purchase Price, payable full cash to seller at closing, then Developer will enter into a purchase and sale agreement with the Qualified Buyer in a form mutually acceptable to the Agency, Developer and the Qualified Buyer (the "Third-Party Purchase and Sale Agreement"), and upon request at Closing Developer will quitclaim any rights to such Lot arising under this Agreement. If (i) no Qualified Buyer offers to buy the Lot during the Marketing Period for at least the Minimum Purchase Price, (ii) the Parties and the Qualified Buyer cannot agree on the form of Third-Party Purchase and Sale Agreement or (iii) any such Qualified Buyer defaults under the Third-Party Purchase and Sale Agreement, then the Lot in question will not be sold to the specified Qualified Buyer and instead will again be available for purchase by a Developer/Community Builder Venture under this Section 2.4; provided, however, that if either Party so elects within ten (10) days after notice of a default by the Qualified Buyer for Developer to pursue specific performance against the Qualified Buyer, then Developer will initiate and diligently prosecute an action for specific performance. The initiating Party will bear the reasonable cost of the specific performance action if it is unsuccessful, but if it is successful then both Parties will bear the cost in equal shares.

(d) Criteria for Developer/Community Builder Ventures and Marketing Procedures. The criteria for Developer/Community Builder Ventures, and marketing procedures for Community Builder Lots, are set forth in Section 3.2 of Exhibit B of Attachment 24.

(e) Vertical DDA. At the closing of any Transfer of a Lot before it is Built-Out, the Vertical DDA provided for by Section 15.5 of the Agreement and Attachment 27 shall include and bind the Transferee to the provisions of Sections 2.3 and 2.4 of this Alternative Plan, and all defined terms herein that relate to the Profit Participation or any other matters referred to in such Sections. At the Agency's election, exercisable in its sole discretion, a deed of trust shall be recorded at the closing of any Transfer of a Lot before it is Built-Out, subordinate only to any first-lien construction financing for the Vertical Improvements, securing the Agency's right to payment of the Profit Participation under the Vertical DDA. At closing of the purchase and sale of a Lot, all Transferees shall execute, deliver and record a Vertical DDA for the Lot(s) conveyed incorporating the terms and conditions set forth in Attachment 27. Except as expressly provided otherwise in this Agreement or in the Guaranty, no Transferee shall be liable for an Event of Default by Developer or another Transferee in the performance of its respective

obligations under this Agreement, and Developer shall not be liable for the default by any Transferee in the performance of its respective obligations under such Vertical DDA.

2.5 Revisions to Option. Notwithstanding the above, Developer may request the Agency in writing to consider, in its sole discretion, a revision to the lump-sum payment portion of the option under which Developer would irrevocably obligate itself (subject to customary and mutually acceptable reasonable closing conditions) to purchase Parcel A-1 for a specified all-cash purchase price prior to expiration of the Option Period, and the Agency would have the right to put Parcel B-1 to Developer for the difference between the specified price and the Land Value (again subject to customary and mutually acceptable reasonable closing conditions) at any time within five (5) years after expiration of the Option Period. The Agency's Profit Participation, and its right to receive the Agency Land Return on any unpaid portion of the Land Value, would continue intact. If Developer timely makes this request, and Agency agrees, in its sole discretion, then each Party will cooperate in good faith to execute and deliver an amendment to this Agreement effecting the above revisions as soon as reasonably practicable.

Section 3. Financing.

3.1 General. The Mello-Roos Bonds will be secured and issued as provided in Section 2.1 of Attachment 25.

3.2 Distribution. Immediately upon sale of the Mello-Roos Bonds, the Bond Proceeds will be used first to pay for the Public Facility Predevelopment Costs, up to a maximum of Ten Million Dollars (\$10,000,000.00), with any remaining balance first to pay the Public Facility Pre-Agreement Costs, then to initially fund the Mello-Roos Reserve. The remainder, the "Net Bond Proceeds", will be deposited into the Bond Proceeds Account and may be used only to pay debt service on the Mello-Roos Bonds (and any mutually acceptable prepayments of principal, to the extent feasible), and the Public Facility Approved Expenses.

3.3 Accounting. Developer and the Agency will separately track all Bond Proceeds in order to comply with the requirements that (a) Bond Proceeds may be used only for purposes consistent with their tax-exempt status and in accordance with this Agreement and (b) the amount of Public Facility Predevelopment Costs payable from Bond Proceeds do not exceed Ten Million Dollars (\$10,000,000.00).

Section 4. Bond Proceeds Accounts.

4.1 Bond Proceeds Accounts. Developer will establish and maintain the Bond Proceeds Accounts with financial institutions approved by the Agency in writing. Developer will not commingle funds held in the Bonds Proceeds Accounts with other funds held by Developer. The Agency will have a security interest in the Bond Proceeds Accounts subordinate only to the security interest held by the holders of the Mello-Roos Bonds. The Agency's security interest will be evidenced by a UCC-1 Financing Statement and a control agreement with each financial institution holding a Bond Proceeds Account. Developer will cooperate with the Agency in obtaining control agreement(s) and preparing and filing such Financing Statement and any continuation statements required to keep the Financing Statement effective. Any statements and

all other records related to the Bond Proceeds Account will be available for the Agency's review and audit in accordance with Section 5.6 below.

4.2 Distributions from the Bond Proceeds Account. Distributions of Net Bond Proceeds from the Bond Proceeds Account shall be made only to pay debt service on the Mello-Roos Bonds (and any mutually acceptable prepayments of principal, to the extent feasible) and the Public Facility Approved Expenses.

4.3 Reserves. Developer will maintain such reserve as may be required under customary underwriting requirements for issuance of the Mello-Roos Bonds (the "Mello-Roos Reserve") in the Bond Proceeds Account.

Section 5. Budget.

5.1 Caps on Predevelopment and Pre-Agreement Costs. Developer and the Agency have agreed upon certain caps for Qualified Predevelopment Costs and Qualified Pre-Agreement Costs. The amount and nature of those costs are described in Exhibits B and C attached to Attachment 25, which Exhibit is incorporated in this Attachment 26 by reference. Notwithstanding the foregoing, as set forth in the Phase 2 Exclusive Negotiating Agreement (as defined in the Agreement) entered into by Developer and the Agency on the Effective Date of the Agreement, up to Three Million One Hundred Six Thousand Five Hundred Dollars (\$3,106,500.00) of the earliest incurred Qualified Predevelopment Costs will be deferred to Phase 2, but these deferred amounts will not accrue interest.

5.2 Preliminary Budget. Developer and the Agency have also agreed on the Preliminary Budget set forth in Exhibit A to Attachment 25, which Exhibit is incorporated in this Attachment 26 by reference, to be updated on a specified basis by Developer, as set forth below.

5.3 Initial Update of Preliminary Budget at Close of Escrow. Developer will update the Preliminary Budget, and provide a copy of the proposed update to the Agency together with supporting information substantiating all proposed changes thereto (in a form reasonably acceptable to the Agency), no more than sixty (60) and no less than thirty (30) days prior to Close of Escrow. Developer will consult with the Agency on its proposed update, but the Agency will not have approval rights over the updates; provided, however, that Developer will not change the provisions dealing with the Mello-Roos Bonds without the Agency's prior written consent, which the Agency may grant or withhold in its sole discretion.

5.4 Annual Update of Budgets. Developer must update the Budget on an annual basis by providing a copy of the update to the Agency together with supporting information substantiating all proposed changes made to the Budget (in a form reasonably acceptable to the Agency), no more than sixty (60) and no less than thirty (30) days prior to each anniversary of the end of Developer's fiscal year. Developer will consult with the Agency on its proposed update, but the Agency will not have approval rights over the updates; provided, however, that Developer will not change the provisions dealing with the Mello-Roos Bonds without the Agency's prior written consent, which the Agency may grant or withhold in its sole discretion.

5.5 Other Changes to Budgets. If Developer desires to change a Budget in a manner that will reduce the Net Revenue shown in the then current Budget by more the ten percent

(10%), then Developer will provide a copy of the proposed change to the Agency together with supporting information substantiating the proposed change (in a form reasonably acceptable to the Agency), no more than sixty (60) and no less than thirty (30) days prior to the date on which Developer proposes to implement the change. Developer will consult with the Agency on its proposed change, but the Agency will not have approval rights over the change; provided, however, that Developer will not change the provisions dealing with the Mello-Roos Bonds, without the Agency's prior written consent, which the Agency may grant or withhold in its sole discretion.

5.6 Developer's Records and the Agency's Audit Rights. Developer will maintain books and records of all receipts and disbursements related to Phase 1 in accordance with generally accepted accounting principles consistently applied, or in another auditable form approved by the Agency in advance and in writing (collectively, the "Records"). Developer will maintain the Records in the City or at a mutually agreeable storage facility for at least ten (10) years after the Agency issues a Certificate of Completion for the Horizontal Improvements in Phase 1. The Agency shall have the right at any time, after reasonable notice, to inspect and copy Developer's Records. If, after an inspection, the Agency disputes any matters set forth in the Records, or any payments or disbursements made by Developer, then the Agency shall be entitled to retain an independent certified public accountant to copy, review and/or audit the Records, after reasonable notice and at reasonable times. If the audit or review shows any discrepancy, then Developer will correct the discrepancy, and the Party owing funds will pay such funds to the other Party, as the case may be, within thirty (30) days after the audit results are made available to Developer and the Agency. The payment will include interest at the Advance Interest Rate from and after the date the discrepancy arose to and including the date the discrepancy is rectified. The Agency will pay the costs of any inspection, audit or review, unless the audit reveals a discrepancy of more than two percent (2%) of the amount properly due, exclusive of interest, in which case Developer will pay the cost of the inspection, review or audit within thirty (30) days after receipt of an invoice from the Agency.

5.7 Vertical Developer's Records and the Agency's Audit Rights. The Vertical DDA will require each Vertical Developer to maintain books and records of all receipts and disbursements related to the Lots it develops in accordance with generally accepted accounting principles consistently applied, or in another auditable form approved by the Agency in advance and in writing (collectively, the "Records"). Each Vertical Developer will maintain the Records in the City or at a mutually agreeable storage facility for at least ten (10) years after the Agency issues a Certificate of Completion for the final Unit or Multi-Tenant/Commercial Facility Vertical Developer is developing. The Agency shall have the right at any time, after reasonable notice, to inspect and copy each Vertical Developer's Records. If, after an inspection, the Agency disputes any matters set forth in the Records, or any payments or disbursements made by a Vertical Developer, then the Agency shall be entitled to retain an independent certified public accountant to copy, review and/or audit the Records, after reasonable notice and at reasonable times. If the audit or review shows any discrepancy, then the Vertical Developer will correct the discrepancy, and the Party owing funds will pay such funds to the other Party, as the case may be, within thirty (30) days after the audit results are made available to the Vertical Developer and the Agency. The payment will include interest at the Advance Interest Rate from and after the date the discrepancy arose to and including the date the discrepancy is rectified. The Agency will pay the costs of any inspection, audit or review, unless the audit reveals a discrepancy of

more than two percent (2%) of the amount properly due, exclusive of interest, in which case Developer will pay the cost of the inspection, review or audit within thirty (30) days after receipt of an invoice from the Agency.

5.8 Use of Land Value and Profit Participation for Community Benefits.

As set forth in Section 2.1 of Attachment 23, net revenues (net of the Agency's administrative costs) received by the Agency from the Alternative Plan Consideration will be deposited in an separate account or sub-account and used solely for community benefits in the BVHP Area, as provided more fully in Attachment 23.

**LIST OF EXHIBITS IN ATTACHMENT 25 INCORPORATED IN
ATTACHMENT 26 BY REFERENCE**

- Exhibit A Preliminary Budget and Project Pro Forma**
- Exhibit B Description of Qualified Predevelopment Costs**
- Exhibit C Description of Pre-Agreement Costs**

ATTACHMENT 27

OUTLINE OF PROVISIONS OF VERTICAL DISPOSITION AND DEVELOPMENT AGREEMENT

This Outline of Provisions of Vertical Disposition and Development Agreement ("Vertical DDA Outline") is attached to and made part of the Disposition Development Agreement (the "Agreement") for Hunters Point, Phase I. Terms not defined in this Outline have the meanings given to them in the Agreement.

It is a mutual condition precedent to the obligation of each of the Agency and Developer to close escrow for Parcel A-1 that the parties have agreed upon mutually satisfactory documents governing vertical improvements consistent with this Vertical DDA Outline. Each of the Developer and the Agency shall use commercially reasonable efforts to timely satisfy this condition. The Agency and Developer shall negotiate and mutually agree to a Vertical Disposition and Development Agreement and any agreements related thereto (the "Vertical DDA") as soon as possible after the Effective Date of the Agreement. Upon the close of escrow for any Lot conveyed to any Vertical Developer, (i) the parties shall enter into a Vertical DDA, (ii) the Agency shall execute and deliver to the appropriate parties documentation necessary to release the lien of the Agreement to the extent it encumbers such Lot, (iii) the Agreement shall be modified to exclude such Lot from its coverage, and (iv) the Agency shall release Developer from any liability under the Agreement with respect to such Lot (other than indemnity obligations relating to the period of Developer's ownership and other provisions which by their nature are intended to survive transfer of such Lot), with the intent that the Vertical DDA shall be the sole and exclusive agreement between the Agency or the Developer on one hand and the Vertical Developer on the other. The Vertical DDA shall include the relevant obligations of the Agreement to the extent they relate to the Lot in question.

The Vertical DDA shall be reasonably flexible in order to respond to the type of and timing of Vertical Improvements being constructed. However, such document shall generally include the following terms and provisions.

1. General. The Vertical DDA should generally serve as a model for the documents governing vertical development, with appropriate changes to reflect the nature of the improvements.

2. Parties. Parties to the documents will be Developer, the particular Vertical Developer and Agency.

3. Release of Lien of Vertical DDA. Upon the Vertical Developer's request, the Agency and Developer shall cause the lien of the Vertical DDA to be released as to a particular residential ownership unit concurrently with the first sale of that unit to an unrelated Buyer. Any indemnity obligations on the part of the Vertical Developer relating to the period of its ownership will survive expiration of the Agreement.

4. Escrow. The Vertical Developer shall acquire the Lot in question from Developer through an escrow established with a title company satisfactory to Developer, Vertical Developer and the Agency.

5. Entry by Vertical Developer. Prior to closing on the Lot in question, the Vertical Developer shall have access to the Lot for non-invasive investigation pursuant to a Permit to Enter issued by the Developer in a form attached to the Vertical DDA.

6. Closing Conditions. Closing conditions for Vertical Developer's obligation to close shall include Vertical Developer's compliance with all obligations of the Vertical DDA, including any preclosing requirements included in the Schedule of Performance, evidence of available financing required for the Vertical Improvements, Agency's and Developer's approval

of construction documents, the execution of construction contracts reasonably satisfactory to the Agency, the issuance of building permits (provided that if all parties agree to a fast track process, only a site permit and first addendum will be required), and Developer's delivery of required insurance certificates and bonds. Any of the foregoing conditions may be omitted from the Vertical DDA or waived upon the mutual agreement of Developer and Agency.

7. As Is. Developer shall sell the Lot to the Vertical Developer "as is" and Developer and Agency shall be released from any liability arising in connection with the condition of the Lot, including without limitation environmental condition. Vertical Developer shall also provide Developer and the Agency with an indemnity against Vertical Developer's violation of law or release of the hazardous substance.

8. Schedule of Performance and Construction. The Vertical DDA shall contain a Schedule of Performance tied to certain key events measured from production of construction documents and the close of escrow. The Vertical DDA will include a process for refining the Schedule of Performance to include times for Vertical Developer submission, and response times for the Developer's and Agency's review and for Vertical Developer's response, for (i) tentative and final subdivision maps, and a final public report from the California Department of Real Estate, for Vertical Improvements consisting of single family subdivisions or condominium units; and (ii) site permit or building permit applications, in the case of non-ownership residential and commercial, industrial and other projects. The Schedule of Performance shall address times for Vertical Developer submissions and Developer's and Agency's review and responses, for all preconstruction plan approvals and entitlements, and Vertical Developer's response thereto, and shall include time periods for obtaining financing, commencement of construction and completion of construction. The review of construction documents shall be subject to the

Design, Review and Document Approval Procedure for Vertical Improvements ("Vertical DRDAP") and the Interagency Cooperation Agreement. The outside date for completion of construction shall be measured from the date of conveyance to the Vertical Developer, and shall be agreed upon between the Agency and Developer in the Vertical DDA.

9. Construction Obligation. Vertical Developer shall be obligated to construct the Vertical Improvements pursuant to construction documents approved by Developer and the Agency.

10. Mortgage Protection. The Vertical DDA shall include customary and commercially reasonable terms for subordination of certain provisions of the Agreement, including Attachment 22 (Affordable Housing Program), and forbearance in the exercise of any remedy by Developer or the Agency pending provision to any secured lender or the Vertical Improvements of notice and the right on the part of such lender to cure Vertical Developer default and acquire Vertical Developer's interest in a lot by foreclosure or otherwise .

11. Allocation of Affordable Housing Obligations. The Vertical DDA shall include an allocation to each Lot of the obligations under the Affordable Housing Program included in the Agreement and based upon the designations or formula set forth in Attachment 2 and Attachment 22 to the Agreement, as modified only by the mutual agreement of Agency and Developer on or before the date of Lot transfer, and shall include provisions for "suballocation" of such obligations among multiple individual project sites within any Lot or, if such sites are not identifiable at the time of Vertical DDA, a process for such allocation to future individual project sites.

12. Progress of Construction. Developer and the Agency shall have access to the Lot during construction for inspection and other purposes. The Vertical Developer shall submit

written progress reports as reasonably requested by Developer or the Agency. The Vertical Developer shall have sole responsibility for obtaining all land use and construction entitlements and permits for the Vertical Improvements.

13. Certificate of Completion. The Vertical DDA will include procedures for the Agency [and Developer] to issue a Certificate of Completion for a particular residential condominium or single family ownership unit, as well as for the entire Vertical Improvement.

14. Declaration of Restriction. The Lot shall be subject to the Redevelopment Plan, the Design for Development, a particular Declaration of Restrictions and the Vertical DDA.

15. Transfer. Prior to issuance of a Certificate of Completion, a Vertical Developer shall not be allowed to transfer its interest in the Lot, the Vertical Improvements or the Vertical DDA, except in accordance with defined provisions. The Vertical DDA shall set forth provisions regarding participation of Agency in the Vertical Improvements Net Profits set forth in Attachment 26 to the Agreement, to the extent such provisions apply.

16. Default And Remedies. Among the remedies available to Developer and Agency shall be a right to recover the Lot through exercise of a right of reverter in the Vertical DDA and other legal and equitable remedies. The Vertical DDA shall give Developer a reasonable, specified time period to cure any Vertical Developer default and to exercise a right of reverter in favor of Developer to be included in the Vertical DDA, and if Developer fails to do so, then Agency may step in and cure or exercise its own right of reverter and other remedies.

17. Open Space Master Plan. The Vertical Developer will comply with those portions of the Open Space Master Plan, and of the funding plan for maintaining and operating the Open Space, that apply to the Lot(s) acquired by the Vertical Developer. This may require the Vertical Developer to provide funding for such purposes.

18. Permanent Employment. The Vertical DDA shall include permanent employment requirements similar to those set forth in Attachment 24 A, Rider 3 of the DDA titled “Permanent Work Force of the Developer and Retail Tenants”. The Vertical DDA shall also include financial incentives tied to local hiring (incentives will be tailored to fit uses covered by the specific Vertical DDA).

19. Attachments. The Attachments to the Agreement to be incorporated in the Vertical DDA, appropriately modified for the Vertical DDA, include Attachments 7, 13, 14, 15, 16, 17, 18, 19, 20, 21, 22 and 24.

ATTACHMENT 28

Hunters Point Shipyard Transportation Management Association (HPS TMA)

INTRODUCTION

This document describes the role, responsibilities, and programs of the proposed Hunters Point Shipyard Transportation Management Association (HPSTMA)

Hunters Point Shipyard EIR (HPS EIR) and Development Disposition Agreement (DDA) require that a Hunters Point Shipyard Transportation Management Association be established. HPSTMA will involve HPS developers (Lennar/BVHP (Developer) and its designers) and businesses within the Hunters Point Shipyard (HPS), key City and County of San Francisco agencies, and the community stakeholders. Under Section 1.A.1 of Attachment 11, the interim HPSTMA will be appointed by the Mayor in collaboration with the Agency, Developer and the District 10 Supervisor. The purpose of the HPSTMA is to implement the mitigation measures outlined in the adopted *Mitigation Monitoring and Reporting Program*, January 19, 2000 (Monitoring Program).

The formation of the HPSTMA will involve the following three stages:

- Formation phase – During this phase, the structure of the HPSTMA will be established.
- Initial start-up phase – During this phase, the implementation of the initial phases of Transportation Systems Management Plan (TSMP) projects will begin.
- Operational phase – During this phase, most of the TSMP projects are in place, the focus is annual maintenance of the TSMP project.

SECTION 1: PROJECT DESCRIPTION

The Hunters Point Shipyard project consists of approximately 550 acres and is located at the southeastern section of the City and County of San Francisco. The project area is divided into five major parcels (A through E). Phasing of the development is dependent upon the hazardous materials clean-up schedule and land transfer schedule between the US Navy and the City and County of San Francisco Redevelopment Agency (Agency).

The first phase development will involve Parcel A-1 and Parcel B-1, as defined in the DDA. The Phase 1 program consists of 1,600 residential units and 300,000 total sq. ft. of commercial space.¹ The Hillside and Hilltop residential areas in Parcel A-1 (the Hill Neighborhoods) would contain about 1,300 units of housing. Preliminary plans call for the remaining 300 residential units to be above retail and office uses east of Donahue Street in Parcel B-1. Preliminary plans call for Parcel B-1 (Lockwood Landing) to be developed into 220,000 sq. ft. of research & development (R&D)/office, and 30,000 sq. ft. of support retail space. At the entrance on Parcel A-1 preliminary plans call for 50,000 sq. ft. of neighborhood-serving retail/commercial space.

Table 1 presents the gross square feet of development that will be developed as part of the Phase one development.

Table 1 – Hunters Point Shipyard Phase 1 Land Use and Estimated Number of Residents/Employees

Land Use	Gross Sq Ft/Dwelling Units	Employees/Residents
Residential (units)	1,600	
Research & Development Office (gsf)	220,000	
Supporting Retail (gsf)	80,000	

¹ Conceptual Framework for Phase 1 Development of the Hunters Point Shipyard, January 13, 2003, p. 3.

SECTION 2: HUNTERS POINT SHIPYARD TRANSPORTATION MANAGEMENT ASSOCIATION

Mission

The purpose of the HPSTMA is to implement the transportation systems management mitigation measures as outline in the HPS EIR. The mission of the HPSTMA is to ensure that the potential transportation impacts to be generated by the HPS project will be mitigated and to monitor the necessary transportation planning goals and objectives established by the HPS Reuse Plan after implementation.

Organizational structure

Transportation Management Associations (TMAs) are typically private, non-profit, member-controlled organizations that provide transportation services in a particular area, such as a medical center or a business park. Transportation Management Coordinators (TMC) are professionals who work for TMAs or individual employers, responsible for implementing the transportation program established by the TMA. TMAs usually focus on the travel needs of large employers, and are often created to give businesses a voice in local government transportation planning, to advocate for enhanced mobility, and to reduce employer costs of implementing individual worksite transportation programs through economies of scale.

The HPS TMA will be a formal organization of developers, home owner associations and businesses within HPS, City and County of San Francisco government agencies, and community stakeholders dedicated to addressing local transportation concerns. There will be a five-member Board of Directors (initially appointed by the Mayor, in collaboration with Developer and the District 10 Supervisor) and a Steering Committee. The Board of Directors will reflect a balanced membership between interested parties providing no one single entity with a majority of votes. The Board of Directors will include two representatives from the businesses/home owners within the Shipyard, one from the City and County of San Francisco, and two from the Bayview Hunters Point Area (meaning areas encompassed within the 94124, 94134 and 94107 zip codes as of the Effective Date of the Agreement) outside of the Shipyard. The Steering Committee (which will also initially be appointed by the Mayor, in collaboration with Developer and the District 10 Supervisor) will be an eleven-person Committee, including the following members:

- TMA Executive Director (an ex-officio member who will vote only when required to break a tie vote)
- Developer
- San Francisco Redevelopment Agency
- San Francisco Department of Parking and Traffic
- San Francisco Department of Public Works
- San Francisco MUNI

- Five representatives from the Bayview Hunters Point Area, at least two of whom shall be representatives of the CAC

The Board and the Steering Committee will be subject to the Brown Act and other applicable open public meetings/sunshine ordinances, as well as laws and regulations governing conflicts of interest. The creation of the HPSTMA framework should begin immediately with participation from the steering committee members. Participation in the TMA by the HPS businesses and residents will be required through leasing/sales agreement. The initial tasks would involve the following:

- Establish a clear mission statement of the HPSTMA.
- Establish its legal status as a non-profit 501 (c) (3) organization, and establish the organization, including staffing, budget, office space, equipment and supply, insurance, and payroll.
- Decide how the services will be provided (on a fee basis or membership basis).
- Establish specific criteria on how the individual projects would be phased in the future and implementation strategies.
- Establish the roles and responsibilities of the Board of Directors and the Steering Committee.
- Establish communication protocol.

TMA Funding

The HPSTMA shall be funded initially by Developer as a Soft Cost under Attachment 25 of the DDA, and eventually be a fee-based or membership-based organization, funded by the participating businesses and residents.

TMA Staffing

The HPSTMA would initially begin with an Executive Director, who will work on a part-time basis to establish the organization's structure.

Eventually the HPSTMA could have a full time TMC and a number of full time staff persons (TMC and administrative staff), depending on the level of activities involved.

Transportation Systems Management Plan (TSMP)

The TSMP elements include those required elements listed in the Monitoring Program and other elements that would improve transportation at the Shipyard due to its unique location and access. Table 1 presents a list of TSMP projects, when these projects should be implemented, and which organization/agency would be responsible for implementing them.

The TSMP projects will be implemented in phases. Implementation of most of the projects will not begin until several years after the initial occupancy of the HPS.

However, it is appropriate to define the TSMP projects now and establish the framework for how and when these projects will be implemented.

Transportation Systems Management Plan

TSMP Elements	Implementation Time Frame	Implementation Agency
<p>Promotional materials</p> <ul style="list-style-type: none"> - Provide MUNI, Caltrain, BART, AC Transit, SamTrans maps and schedules. - Publish newsletters regarding transportation services on-site and status of future transportation improvements. 	<ul style="list-style-type: none"> - Initially include the information in the pre-leasing/sell packets. Once the site is occupied, make them available at the TMA office. - Initially include the information in the leasing/sell packets. Once the site is occupied, publish annually and send it to all residents and businesses on-site. 	<ul style="list-style-type: none"> - TMA - TMA
<p>Coordination/Promotional Activities</p> <ul style="list-style-type: none"> - Work with RIDES for Bay Area Commuters on rideshare matches. - Promote flex work hours. - Provide carshare service and carshare spaces. - Provide commuter check program to employees. - Sponsor annual "Transportation Day" event. - Establish a web page that would include necessary TMA related materials and transportation links 	<ul style="list-style-type: none"> - Offer this service as soon as the site is available for occupancy. - Include in the pre-leasing packet for commercial tenants that this policy is encouraged within the site. - Begin when the site has more than 300 residents and/or 300 workers, whichever comes sooner. - Include in the pre-leasing packet for commercial tenants that this policy is encouraged within the site. - Begin when the site has more than 300 residents and/or 300 workers, whichever comes sooner. - Begin as soon as the site is available for occupancy 	<ul style="list-style-type: none"> - TMA - TMA/businesses - TMA - TMA/businesses - TMA - TMA
<p>Management Activities</p> <ul style="list-style-type: none"> - Develop a shared-parking strategy. - Designate close-in parking spaces as carpool/vanpool spaces. 	<ul style="list-style-type: none"> - Begin when the site would have a significant amount of mixed-use development, so shared parking would be a benefit to the Shipyard. - For every non-residential parking facility on site. Criteria should be established by the TMA. 	<ul style="list-style-type: none"> - TMA - TMA

<p>Physical improvements</p> <ul style="list-style-type: none"> - Ensure that pedestrian and bicycle pathways are provided on-site. - Ensure that roadways and intersections will be designed with sufficient capacity. 	<ul style="list-style-type: none"> - Per reuse plan for each phase of development - Per reuse plan for each phase of development 	<ul style="list-style-type: none"> - TMA/Developer/City and County of SF - TMA/Developer/City and County of SF
<p>Transit service improvements</p> <ul style="list-style-type: none"> - Coordinate with MUNI to ensure MUNI provides high level of transit services to the Shipyard as outlined in the HPS reuse plan, including increased service on #19 line and extension of #23 and 54 lines. - Explore the viability of a ferry service. - Explore the need for supplemental shuttle bus operation. 	<ul style="list-style-type: none"> - Continued coordination beginning when the site is ready for occupancy - When the site has at least 4,000 population and/or 4,000 jobs or as demand warrants - To be determined by the TMA 	<ul style="list-style-type: none"> - TMA/MUNI - TMA/WTA - TMA/MUNI
<p>Annual reporting</p> <ul style="list-style-type: none"> - Conduct annual surveys at the front and back gates regarding vehicle trips and occupancy on a typical weekday. - Prepare annual progress report to the TMA board and SFRA. 	<ul style="list-style-type: none"> - Conduct this survey annually in mid-May. - Prepare an annual report to SFRA in June. 	<ul style="list-style-type: none"> - TMA - TMA

INTERIM LEASE

between the

**THE REDEVELOPMENT AGENCY
OF THE
CITY AND COUNTY OF SAN FRANCISCO**

("Agency")

and

**LENNAR/BVHP, LLC
a California limited liability company
dba Lennar/BVHP Partners**

("Tenant")

Dated: as of December 3, 2004

**Marcia Rosen
Executive Director**

SAN FRANCISCO REDEVELOPMENT AGENCY

TABLE OF CONTENTS

ARTICLE 1. PREMISES; TERM; DEFINITIONS	2
1.1 Lease of Premises	2
(a) Leased Premises; Description	2
(i) Leased Premises	2
(ii) Additional Premises	2
(b) Active Premises; Passive Premises	3
(i) Active Premises	3
(ii) Passive Premises	3
(c) Tenant's Right to Convert Portions of the Premises	3
1.2 Term	3
(a) Commencement Date	3
(b) Expiration Date	3
1.3 Definitions	4
ARTICLE 2. USES; DEDICATED REVENUES	4
2.1 Permitted Uses within Premises	4
2.2 Permitted Subleases	4
2.3 Limitations on Uses by Tenant	4
(a) Prohibited Activities	4
(b) Land Use Restrictions	5
(c) Regulatory Approvals	5
2.4 Common Areas	5
ARTICLE 3. RENT; SECURITY DEPOSIT	5
3.1 Tenant's Covenant to Pay Rent	5
3.2 Percentage Rent	6
3.3 Additional Rent	6
3.4 Manner of Payment	6
3.5 No Abatement or Setoff	7
3.6 Net Lease	7
3.7 Guaranty	7
ARTICLE 4. CONDITION OF PREMISES	7
4.1 Tenant's Investigation	7
4.2 "AS-IS WITH ALL FAULTS."	8
4.3 Easements	9
4.4 Subsurface Mineral Rights	10
ARTICLE 5. LEASEHOLD IMPROVEMENTS AND ALTERATIONS	10
5.1 Title to Improvements	10
5.2 Agency's Right to Approve Construction	10
(a) Construction Requiring Approval	10
(b) Permits	10
5.3 Approval of Minor Alterations; Major Alterations	10
5.4 Utility Services	11

ARTICLE 6.	REQUIRED MAINTENANCE AND REPAIR SERVICES	11
6.1	Required Services	11
(a)	Baseline Services	11
(b)	Active Services	11
6.2	[Reserved.]	11
6.3	No Obligation of Agency; Waiver of Rights	11
6.4	Notice	11
6.5	Security Services	12
(a)	Agency's Security Services Responsibilities	12
(b)	Tenant's Security Services Responsibilities	12
ARTICLE 7.	LIENS	13
7.1	Liens	13
7.2	Mechanics' Liens	13
7.3	No Mortgage	13
ARTICLE 8.	TAXES AND ASSESSMENTS	13
8.1	Payment of Possessory Interest Taxes and Other Impositions	13
(a)	Payment of Possessory Interest Taxes	13
(i)	Acknowledgment of Possessory Interest	14
(ii)	Reporting Requirements	14
(b)	Other Impositions	14
(c)	Prorations	15
(d)	Proof of Compliance	15
8.2	Agency's Right to Pay	15
8.3	Right of Tenant to Contest Impositions and Liens	15
ARTICLE 9.	COMPLIANCE WITH LAWS	16
9.1	Compliance with Laws and Other Requirements	16
(a)	Tenant's Obligation to Comply	16
(b)	Unforeseen Requirements	16
(c)	Proof of Compliance	17
9.2	Regulatory Approvals	17
(a)	Agency and City Approvals	17
(b)	Approval of Other Agencies	17
ARTICLE 10.	HAZARDOUS MATERIALS	18
10.1	Hazardous Materials Compliance	18
(a)	Compliance with Hazardous Materials Laws	18
(b)	Notice	18
(c)	Agency's Approval of Remediation	19
(d)	Pesticide Prohibition	19
10.2	Hazardous Materials Indemnity	20
ARTICLE 11.	INSURANCE	20
11.1	Required Types and Amounts of Insurance Coverage	20
(a)	Required Insurance	20
(b)	General Requirements	21
(c)	Certificates of Insurance; Right of Agency to Maintain Insurance	21
(d)	Insurance of Others	21

11.2 Agency Entitled to Participate.	21
ARTICLE 12. INDEMNIFICATION OF AGENCY.	22
12.1 Indemnification of Agency.	22
12.2 Immediate Obligation to Defend.	22
12.3 Not Limited by Insurance.	23
12.4 Survival.	23
12.5 Other Obligations.	23
12.6 Defense.	23
12.7 Release of Claims Against Agency.	23
ARTICLE 13. DAMAGE OR DESTRUCTION.	24
13.1 General; Notice; Waiver.	24
(a) General.	24
(b) Notice.	24
(c) Waiver.	24
13.2 Rent after Damage or Destruction.	24
13.3 Tenant's Obligation/Election to Restore.	24
13.4 Significant Damage and Destruction or Uninsured Casualty.	25
(a) Tenant's Election to Restore or Convert Premises.	25
(i) Uninsured Casualty.	25
(ii) Other Circumstances Allowing Conversion.	25
13.5 Tenant's Election Not to Restore.	26
13.6 No Release of Tenant's Obligations.	27
ARTICLE 14. CONDEMNATION.	27
14.1 General; Notice; Waiver.	27
(a) General.	27
(b) Notice.	27
(c) Waiver.	27
14.2 Total Condemnation.	27
14.3 Substantial Condemnation, Partial Condemnation.	27
(a) Substantial Condemnation.	28
(b) Partial Condemnation.	28
14.4 Condemnation Awards.	28
14.5 Temporary Condemnation.	29
14.6 Relocation Benefits, Personal Property.	29
ARTICLE 15. ASSIGNMENT AND SUBLETTING.	29
15.1 Assignment.	29
(a) Prohibited Without Consent of Agency.	29
(b) Conditions.	29
(c) Delivery of Executed Assignment.	30
(d) No Release of Tenant's Liability or Waiver by Virtue of Consent.	31
(e) Notice of Significant Changes; Reports to Agency.	31
(f) Determination of Whether Consent is Required.	31
(g) Scope of Prohibitions on Assignment.	31
15.2 Assignment of Rents.	31
15.3 Subletting by Tenant.	31

15.4	Artists' Subleases.....	33
15.5	Non-Disturbance of Subtenants, Attornment, Sublease Provisions.....	33
	(a) Conditions for Non-Disturbance Agreements.....	33
	(b) Form of Non-Disturbance Agreement.....	34
ARTICLE 16.	AGENCY'S RIGHT TO PERFORM TENANT'S COVENANTS.....	35
16.1	Agency May Perform in Emergency.....	35
16.2	Agency May Perform Following Tenant's Failure to Perform.....	35
16.3	Tenant's Obligation to Reimburse Agency.....	36
ARTICLE 17.	EVENTS OF DEFAULT; TERMINATION.....	36
17.1	Events of Default.....	36
ARTICLE 18.	REMEDIES.....	37
18.1	Agency's Remedies Generally.....	37
18.2	Right to Terminate Lease.....	38
	(a) Damages.....	38
	(b) Interest.....	38
	(c) Waiver of Rights to Recover Possession.....	38
	(d) No Rights to Assign.....	38
18.3	Continuation of Subleases and Other Agreements.....	39
18.4	Agency's Equitable Relief.....	39
18.5	Nonliability of Tenant's Members, Partners, Shareholders, Directors, Officers and Employees.....	39
ARTICLE 19.	DEFAULT BY AGENCY; TENANT'S REMEDIES.....	39
19.1	Default by Agency; Tenant's Exclusive Remedies.....	39
19.2	No Recourse Beyond Value of Premises Except as Specified.....	40
19.3	No Recourse Against Specified Persons.....	40
19.4	Tenant's Equitable Relief.....	40
19.5	Arbitration of Certain Matters.....	40
ARTICLE 20.	LIMITATIONS ON LIABILITY; ESTOPPEL CERTIFICATE.....	42
20.1	Waiver of Consequential Damages.....	42
20.2	Limitation on Parties' Liability Upon Transfer.....	42
20.3	Estoppel Certificate by Tenant.....	42
ARTICLE 21.	NO WAIVER.....	43
21.1	No Waiver by Agency or Tenant.....	43
21.2	No Accord or Satisfaction.....	43
ARTICLE 22.	SURRENDER OF PREMISES; HOLDOVER.....	43
22.1	End of Lease Term.....	43
	(a) Conditions of Premises.....	43
	(b) Subleases.....	44
	(c) Personal Property.....	44
22.2	Hold Over.....	44
ARTICLE 23.	NOTICES.....	44
23.1	Notices.....	44
23.2	Form and Effect of Notice.....	45

ARTICLE 24. INSPECTION OF PREMISES BY AGENCY.....	45
24.1 Entry.....	45
24.2 Exhibit for Lease.....	46
24.3 Notice, Right to Accompany.....	46
24.4 Rights of Subtenants.	46
ARTICLE 25. REPRESENTATIONS AND WARRANTIES.....	46
25.1 Representations and Warranties of Tenant.	46
(a) Valid Existence; Good Standing	47
(b) Authority.....	47
(c) No Limitation on Ability to Perform.....	47
(d) Valid Execution.....	47
(e) Defaults.....	47
(f) Financial Matters	47
ARTICLE 26. SPECIAL PROVISIONS.....	48
26.1 Non-Discrimination.	48
(a) Covenant Not to Discriminate	48
(b) [intentionally left blank].....	48
26.2 Contract Requirements.....	48
(a) Equal Opportunity Program	48
(b) Nondiscrimination in Benefits.....	48
26.3 First Source Hiring Ordinance.	48
26.4 Compliance with Minimum Compensation Policy and Health Care Accountability Policy.....	49
26.5 Labor Relations.....	49
26.6 Mitigation Measures.	49
26.7 Waiver of Relocation Assistance Rights.....	50
26.8 Prevailing Wage Provisions.....	50
ARTICLE 27. GENERAL.....	50
27.1 Time of Performance.	50
27.2 Interpretation of Agreement.....	50
27.3 Relationship of Lease to ENA and/or DDA.	51
27.4 Successors and Assigns.....	51
27.5 Estoppel Certificate by Agency.	51
27.6 Approvals by Agency.	52
27.7 Fees for Review.	52
27.8 No Merger of Title.....	52
27.9 Quiet Enjoyment.	52
27.10 No Third Party Beneficiaries.	53
27.11 Real Estate Commissions.....	53
27.12 Counterparts.....	53
27.13 Entire Agreement.	53
27.14 Amendment.....	53
27.15 Governing Law; Selection of Forum.	53
27.16 Recordation.	54
27.17 Extensions by Agency.....	54
27.18 Further Assurances.....	54

27.19 Attorneys' Fees.....	54
27.20 Effective Date.	55
27.21 Severability.	55
27.22 Force Majeure Extensions.....	55
(a) Postponement	55
(b) Notice of Enforced Force Majeure	55
(c) Extensions.....	56
ARTICLE 28. DEFINITIONS.....	56

LIST OF LEASE EXHIBITS

<u>Exhibit</u>	<u>Description</u>
EXHIBIT A-1	Description of Premises
EXHIBIT A-2	Map of Premises
EXHIBIT B	State Lands Parcel
EXHIBIT C	[Reserved]
EXHIBIT D	[Reserved]
EXHIBIT E	Scope of Required Services
EXHIBIT E-1	Baseline Services
EXHIBIT E-2	Active Services
EXHIBIT F	Insurance
EXHIBIT G	Fencing and Lighting Plan
EXHIBIT H	Form of Memorandum of Lease

INTERIM LEASE

This INTERIM LEASE (this "Lease") is entered into as of December 3, 2004, by and between THE REDEVELOPMENT AGENCY OF THE CITY AND COUNTY OF SAN FRANCISCO, a public body, corporate and politic of the State of California (the "Agency"), and LENNAR/BVHP, LLC, a California limited liability company doing business as Lennar/BVHP Partners (the "Tenant").

RECITALS

THIS LEASE IS MADE WITH REFERENCE TO THE FOLLOWING FACTS AND CIRCUMSTANCES:

A. In furtherance of the objectives of the Community Redevelopment Law of California, Agency has undertaken a program of redevelopment in the area of the City and County of San Francisco (the "City") known as the Hunters Point Shipyard Project Area (the "Project Area") pursuant to a Redevelopment Plan (the "Plan") approved by the Board of Supervisors of the City by Ordinance No. 285-97 adopted July 14, 1997.

B. The Project Area contains a shipyard known as the Hunters Point Naval Shipyard (the "Shipyard") that was a major center of employment during and after World War II, providing logistics support, construction and maintenance of conventional and nuclear-powered ships of the United States Navy (the "Navy"), providing 17,000 jobs to civilian and military personnel at its peak of operations. The Shipyard employed approximately 6,000 persons at the time it was shut down in 1974, and, since that time, the Bayview-Hunters Point neighborhood has experienced high rates of unemployment, particularly in the African-American community.

C. In 1991, the Navy designated the Project Area for closure as a shipyard and for potential reuse by the community pursuant to the defense base closure and Realignment Act of 1990, Public Law 101-510, Title XXIX, Section 2901 et seq. (104 Stat. 1808 et seq.), which closure was approved in 1991 by the Base Realignment and Closure Commission with the consent of the President and Congress.

D. Pursuant to Section 2824 of Public Law 101-510, as amended by Section 2834 of Public Law 103-160, the Navy has the authority to convey the Project Area to the City or to a local redevelopment authority approved by the City, for such consideration and under such terms as the Secretary of the Navy considers appropriate.

E. To facilitate the expeditious remediation of Hazardous Materials and timely and productive reuse of the Project Area under the Plan, the Navy agreed that remediation of the Project Area should be accomplished on a parcel-by-parcel basis, and delineated in a series of soil site maps six separate parcels of the real property in the Project Area, namely Parcels A, B, C, D, E and F (collectively the "Parcels" and each a "Parcel").

F. On March 30, 1997, the Agency Commission selected Tenant as the most qualified entity to be the master developer of the Property and other portions of the Project Area, and Agency and Tenant have entered into that certain Exclusive Negotiations Agreement (Hunters Point Shipyard) dated as of June 1, 1999, as amended by that certain Amendment to

Exclusive Negotiations Agreement, dated as of September 8, 1999 (the "First Amendment"); that certain Amendment, dated as of October 18, 1999 (the "Second Amendment"); that certain Third Amendment, dated as of March 21, 2000 (the "Third Amendment"); that certain Fourth Amendment, dated as of May 23, 1999 (the "Fourth Amendment"); that certain Fifth Amendment, dated as of October 31, 2000 (the "Fifth Amendment"); and that certain Sixth Amendment, dated as of November 20, 2001 (the "Sixth Amendment," which, together with the First, Second, Third, Fourth and Fifth Amendments, are hereinafter collectively referred to as the "ENA").

G. Agency and Tenant desire that Tenant provide to all of the Premises (as hereinafter defined), at no cost to the Agency, the Baseline Services (as hereinafter defined) and, for certain specified portions of the Premises, the construction of improvements thereon and the Active Services (as hereinafter defined).

H. Agency and Tenant have entered into a Disposition and Development Agreement for a portion of the Project Area, dated December 2, 2003 (the "DDA").

I. Agency, on the basis of the foregoing, and the undertakings of Tenant pursuant to the ENA, the DDA and this Lease, is willing to lease to Tenant the Premises on an interim basis during the pendency of the DDA.

NOW, THEREFORE, in consideration of the mutual promises, for the purposes aforesaid, and other valuable consideration, the receipt and sufficiency of which are hereby acknowledged, the Parties hereby agree as follows:

ARTICLE 1. PREMISES; TERM; DEFINITIONS.

1.1 Lease of Premises.

(a) Leased Premises; Description.

(i) Leased Premises. Subject to the payment of Rent, the covenants, terms and conditions of this Lease, and the rights reserved and obligations imposed by the Navy under the Conveyance Agreement and all related documents in connection with the Navy's conveyance of the Premises to Agency, Agency hereby leases to Tenant, and Tenant hereby leases from Agency, the Property as described in Exhibit A-1 and depicted in Exhibit A-2 both of which are attached hereto (the "Property") and all Improvements now located on the Property (collectively, the "Premises"). The Parties understand, acknowledge and agree that as of the date of the execution of this Lease the Premises consists of Parcel A, containing approximately 75.452 acres of land and includes all structures and substructures affixed thereto, together with all rights, privileges and licenses appurtenant to the Premises which are owned by Agency.

(ii) Additional Premises. Tenant further understands and acknowledges that, subject to the terms and conditions of the Conveyance Agreement, the Premises subject to the terms of this Lease may be amended to include all or portions of any further portions of the Project Area conveyed to Agency (the "Additional Parcels"). Tenant and Agency further agree that in the event (A) Agency takes title to any Additional Parcel;

(B) Tenant is not in default under this Lease, the Utilities Agreement, or any other agreement between Agency (or City) and Tenant related to the development or use of the Shipyard; and
(C) Tenant has the exclusive right to negotiate with Agency for the development of such Additional Parcels pursuant to the ENA (or some comparable instrument granting Tenant the exclusive right to negotiate Transaction Documents for such Additional Parcels), the Additional Parcels shall automatically be added to, and become part of, the Premises for all purposes, and the descriptions of the Premises as described herein shall be amended to include such Additional Parcels on such terms and conditions as set forth in this Lease. The Agency shall give Tenant not less than thirty (30) days' prior written notice of the addition of any Additional Parcel(s).

(b) Active Premises; Passive Premises. Tenant understands, agrees and acknowledges that for purposes of determining the specific scope of Required Services to be performed by Tenant pursuant to Section 6.1 hereof, the Premises shall be, and are hereby, classified into two categories (the proportions of which may be changed from time to time in accordance with the terms and conditions of this Lease) by the Parties as follows:

(i) Active Premises. Those portions of the Premises that are used and/or occupied by Tenant and/or any Subtenant, including, without limitation, the Artists, shall be designated by the Parties as "Active Premises," for which Tenant shall provide all Required Services in accordance with Section 6.1(b).

(ii) Passive Premises. Those portions of the Premises that are (A) not Active Premises, and (B) not retained as Active Premises as a result of the conversion to Passive Premises shall be designated by the Parties as "Passive Premises," for which Tenant shall only be obligated to provide the Baseline Services in accordance with Section 6.1(a).

(c) Tenant's Right to Convert Portions of the Premises. Except with respect to the portions of the Premises occupied by the Artists pursuant to one or more Subleases (the "Artists' Spaces"), but subject to Section 13.4 below, Tenant shall have the right at any time in its sole and absolute discretion to convert any portion of the Premises from Active Premises to Passive Premises, or from Passive Premises to Active Premises, subject in each case to the provision of thirty (30) days prior written notice to the Agency.

1.2 Term.

(a) Commencement Date. The Term of this Lease shall commence on the effective date of the conveyance of the Premises to the Agency pursuant to the Conveyance Agreement (the "Commencement Date").

(b) Expiration Date. This Lease shall expire on the date on which the Agency and Tenant enter into a long-term ground lease or conveyance of the Premises to Tenant, pursuant to the DDA (as herein above defined) or, in the alternative, upon the termination of the DDA without such conveyance for any reason other than default by Tenant thereunder, unless earlier terminated in accordance with the terms hereof or thereof (the "Term").

1.3 Definitions.

All initially capitalized terms used herein are defined in Article 28 or when first defined in this Lease; to the extent they are not defined in this Lease, such terms shall have the meanings given them in the DDA.

ARTICLE 2. USES; DEDICATED REVENUES.

2.1 Permitted Uses within Premises.

Tenant shall use and operate the Premises for the uses in accordance with the terms and conditions of the Conveyance Agreement and the FOST, and solely for the uses permitted by (i) the Redevelopment Plan or other applicable zoning, or (ii) as further required or permitted in this Article 2 (the "Permitted Uses").

2.2 Permitted Subleases.

(a) In the event Tenant elects at its discretion to sublease any portion of the Premises in accordance with Section 15.3 hereof, the use and operation of any Subleased Premises (as hereinafter defined) shall at all times be consistent with the terms of this Lease and any use of the Premises by third parties permitted under Section 2.1(b) shall be subject to all of the terms and conditions of this Lease, including, without limitation, Agency's rights of termination and re-entry.

(b) Tenant shall provide to Agency a copy of any such sublease, license or other agreement within fourteen (14) days following the date of Tenant's execution of such sublease, license or other agreement.

2.3 Limitations on Uses by Tenant.

(a) Prohibited Activities. Tenant shall not conduct or permit on the Premises any of the following activities:

(i) any activity that is not within a Permitted Use or previously approved by the Agency in writing;

(ii) any activity that will cause a cancellation of, any environmental, fire or other insurance policy covering the Premises, any part thereof or any of its contents;

(iii) any activity or object that will materially overload or cause damage to the Premises;

(iv) any activity that constitutes waste or public or private nuisance to owners or occupants of the Premises or adjacent properties. Such activities might include, without limitation, the preparation, manufacture or mixing of anything that might emit any objectionable odors, noises or lights onto adjacent properties, or the use of loudspeakers or sound or light apparatus which can be heard or seen outside the Premises, subject to the provisions of

Articles 5, 13 and 14 of this Lease, and without limitation on any right given Tenant to alter, modify, repair, maintain, Restore, or construct Improvements; and

(v) any activity that will materially injure, obstruct or interfere with the rights of other tenants, owners or occupants of the Premises, adjacent Navy or community properties, including rights of ingress and egress to such properties, except to the extent that such uses are conducted within the Permitted Uses hereunder and in accordance with all Laws and Regulatory Approvals, or are necessary on a temporary basis to allow for the alteration, modification, repair, maintenance, Restoration, or construction of Improvements.

(b) Land Use Restrictions.

(i) Except as permitted by Sections 2.3(b)(ii) and 15.3 hereof, Tenant may not enter into any agreements granting license, easements or access rights over the Premises (individually and collectively, "Access Rights") in each instance without Agency's prior written consent, which consent (A) if requested for Access Rights with a term equal to or less than the term of the Sublease for such portion of the Premises, shall not be unreasonably withheld or delayed, and subject to the provisions of Article 9, or (B) if requested for all other Access Rights, may be withheld in Agency's sole discretion, and subject to the provisions of Article 9.

(ii) Tenant may, without the prior consent of Agency, permit access to, and/or entry upon, the Premises from time to time and at all reasonable times to Tenant's agents, licensees, concessionaires, operators or other persons who, in any case, are authorized by Tenant to use the Premises for such permitted activities as are consistent with the terms of this Lease ("Permitted Licensees"); provided, however, that such access or entry by any Permitted Licensee shall not exceed ninety (90) days and shall be subject to all material terms of a Permit to Enter form reasonably acceptable to Agency.

(c) Regulatory Approvals. The foregoing notwithstanding, the Parties recognize that for Tenant or a Subtenant to carry out its intended use of the Premises, it may be necessary or desirable to obtain additional Regulatory Approvals relating to the Premises.

2.4 Common Areas.

Agency hereby reserves reasonable access rights over the portion of the Premises consisting of the Common Areas so as to permit use of such areas by the general public consistent with the Redevelopment Plan, during such reasonable hours of use as are required by the Agency.

ARTICLE 3. RENT; SECURITY DEPOSIT.

3.1 Tenant's Covenant to Pay Rent.

During the Term of this Lease, Tenant shall pay Rent for the Premises to Agency at the times and in the manner provided in this Article 3.

3.2 Percentage Rent.

Tenant shall pay to Agency percentage rent for any use of the Premises by Tenant in an amount equal to fifty percent (50%) of the Net Operating Income (as hereinafter defined) derived from its use and occupancy of the Premises, including without limitation thereto, all sales and business transacted by Tenant on the Premises ("Percentage Rent").

3.3 Additional Rent.

Except as otherwise provided in this Lease, all costs, fees, interest, charges, expenses, reimbursements and obligations of every kind and nature relating to the Premises that may arise or become due during or in connection with the Term of this Sublease, whether foreseen or unforeseen, which are payable by Tenant to Agency pursuant to this Sublease other than Percentage Rent shall be deemed "Additional Rent." Landlord shall have the same rights, powers and remedies, whether provided by Law or in this Lease, in the case of non-payment of Additional Rent as in the case on non-payment of Percentage Rent.

3.4 Manner of Payment.

(a) Percentage Rent shall be payable on August 1, 2005 for the period that begins on the Rent Commencement Date until June 30, 2005, and thereafter, semi-annually on each February 1 and August 1 of each year of the Term, attributable to the six month period ending on December 31 or June 30, immediately prior to each such payment due date. Along with such payment, the Tenant shall submit such documentation as may be reasonably required by the Agency to verify the actual amount of the Net Operating Income for such six month period prior to each payment due date, including, without limitation thereto, delivering to Agency an accounting (in form and substance satisfactory to Agency) on or before each February 1 and August 1 during the Term. If Agency disputes the amount of Percentage Rent due from Tenant, Agency shall have the right for one hundred twenty (120) days from the date Tenant tenders payment to examine, inspect and audit the Tenant's records upon reasonable notice; provided, however, that the Agency shall have an additional sixty (60) days following its receipt of Tenant's annual audit report to review and audit Tenant's records if there is a disparity between the audit report and the semiannual payments made to Agency. The inspection shall be conducted at Tenant's office(s) at a reasonable time or times. Pending resolution of any disputes over Percentage Rent, Tenant shall pay Agency the amount Tenant has reasonably and in good faith calculated to be payable in that half-year period.

(b) Additional Rent shall be due and payable at the times otherwise provided in this Lease; provided that if no date for payment is otherwise specified, or if payment is stated to be due upon demand", "promptly following notice", "upon receipt of invoice", or the like then such Additional Rent shall be due thirty (30) business days following the giving by Agency of such demand, notice, invoice or the like to Tenant specifying that such sum is presently due and payable. Percentage Rent and Additional Rent shall be paid to Agency in lawful money of the United States of States of America at offices the Redevelopment Agency of the City and County of San Francisco, 770 Golden Gate, San Francisco, California 94102, Attention: Deputy Executive Director, Finance & Administration, or at such other place as Agency may from time to time designate by notice to Tenant.

3.5 No Abatement or Setoff.

Tenant covenants to pay all Rent at the times and in the manner in this Lease provided without any abatement, setoff, deduction, or counterclaim.

3.6 Net Lease.

AGENCY SHALL NOT BE EXPECTED OR REQUIRED TO INCUR ANY EXPENSE OR MAKE ANY PAYMENT OF AN KIND WITH RESPECT TO THIS LEASE OR TENANT'S USE OR OCCUPANCY OF THE PREMISES, INCLUDING ANY IMPROVEMENTS. Without limiting the generality of the foregoing, Tenant shall be solely responsible for paying each item of cost or expense of every kind and nature whatsoever, the payment of which Agency would otherwise be or become liable by reason of Agency's estate or interests in the Premises and any Leasehold Improvements, any rights or interests of Agency in or under this Lease, or the ownership leasing, operation, management, maintenance, repair, rebuilding, remodeling, renovation, use or occupancy of the Premises, any improvements, or any portion thereof. No occurrence or situation arising during the Term, nor any present or future Law, whether foreseen or unforeseen, and however extraordinary, shall relieve Tenant from its liability to pay all of the sums required by any of the provisions of this Lease, or shall otherwise relieve Tenant from any of its obligations under this Lease, or shall give Tenant any right to terminate this Lease in whole or in part. Tenant waives any rights now or hereafter conferred upon it by any existing or future Law to terminate this Lease or to receive any abatement, diminution, reduction or suspension of payment of such sums, on account of any such occurrence or situation, provided that such waiver shall not affect or impair any right or remedy expressly provided Tenant under this Lease.

3.7 Guaranty.

Tenant acknowledges and agrees that the Guaranty set forth as Attachment 9 to the DDA shall cover all of Tenant's obligations under this Lease, and such obligations of Tenant shall be deemed "Guaranteed Obligations" under such Guaranty.

ARTICLE 4. CONDITION OF PREMISES.

4.1 Tenant's Investigation.

Tenant hereby acknowledges that (a) prior to the execution of this Lease, Tenant has inspected the Premises, conducted such studies, and made such investigation as Tenant deems necessary with reference to the condition of the Premises (including, without limitation thereto, environmental aspects, seismic and earthquake requirements, applicable Laws) and to determine the present and future suitability of the Premises for Tenant's intended investment and use; (b) Tenant is satisfied with reference thereto, and assumes all responsibility therefor as the same relate to Tenant's occupancy of the Premises and/or the terms of this Lease; and (c) that Agency has not made any oral or written representations or warranties with respect to said matters.

4.2 "AS-IS WITH ALL FAULTS."

TENANT AGREES THAT THE PREMISES ARE HEREBY ACCEPTED BY TENANT, IN THEIR EXISTING STATE AND CONDITION, "AS IS, WITH ALL FAULTS." TENANT ACKNOWLEDGES AND AGREES THAT (I) PORTIONS OF THE PREMISES HAVE BEEN IDENTIFIED AS A NATIONAL PRIORITIES LIST SITE UNDER THE COMPREHENSIVE ENVIRONMENTAL RESPONSE, COMPENSATION AND LIABILITY ACT (CERCLA) OF 1980, AS AMENDED; AND (II) NEITHER AGENCY NOR ANY OF THE OTHER INDEMNIFIED PARTIES, NOR ANY AGENT OF ANY OF THEM, HAS MADE, AND THERE IS HEREBY DISCLAIMED, ANY REPRESENTATION OR WARRANTY, EXPRESS OR IMPLIED, OF ANY KIND, WITH RESPECT TO THE CONDITION OF THE PREMISES, THE SUITABILITY OR FITNESS OF THE PREMISES OR ANY APPURTENANCES THERETO FOR THE DEVELOPMENT, USE OR OPERATION OF THE PREMISES BY TENANT, THE COMPLIANCE OF THE PREMISES WITH ANY LAWS, ANY MATTER AFFECTING THE USE, VALUE, OCCUPANCY OR ENJOYMENT OF THE PREMISES, OR WITH RESPECT TO ANY OTHER MATTER PERTAINING TO THE PREMISES OR ANY APPURTENANCES TO THE PREMISES.

As part of its agreement to accept the Premises in its "As Is With All Faults" condition, effective upon delivery of possession to the Premises, the Tenant, on behalf of itself and its successors and assigns, shall be deemed to waive any right to recover from, and forever release, acquit and discharge, the Agency, the City, and their Agents of and from any and all Losses, whether direct or indirect, known or unknown, foreseen or unforeseen, that the Tenant may now have or that may arise an account of or in any way be connected with (i) the physical, geotechnical or environmental condition of the Premises, including, without limitation, any Hazardous Materials in, on, under, above or about the Premises (including, but not limited to, soils and groundwater conditions), and (ii) any Laws applicable thereto, including without limitation, Hazardous Materials Laws, or Laws pertaining to historic rehabilitation or preservation but excepting therefrom, however, any claims, demands, or causes of action Tenant may now or hereafter have against the Agency for rights of contribution or equitable indemnity under applicable Laws and except for third party claims, including those arising under any leases at the Site, relating to the period prior to the Commencement Date of this Lease to the extent not arising from the negligence or willful misconduct of Tenant or its Agents.

In connection with the foregoing release, the Tenant acknowledges that it is familiar with Section 1542 of the California Civil Code, which provides as follows:

A GENERAL RELEASE DOES NOT EXTEND TO CLAIMS WHICH THE CREDITOR DOES NOT KNOW OR EXPECT TO EXIST IN HIS FAVOR AT THE TIME OF EXECUTING THE RELEASE, WHICH IF KNOWN TO HIM MUST HAVE MATERIALLY AFFECTED THE SETTLEMENT WITH THE DEBTOR.

Tenant agrees that the release contemplated by this Section includes unknown claims. Accordingly, Tenant hereby waives the benefits of Civil Code Section 1542, or under any other statute or common law principle of similar effect, in connection with the releases contained in

this Section. Notwithstanding anything to the contrary in this Lease, the foregoing release shall survive any termination of this Lease.

Initials: _____

The Agency releases Tenant, its officers, agents and employees for any Losses suffered by the Agency relating to (i) the Navy's violation of any Environmental Law, or (ii) any Release of a Hazardous Substance, or any pollution, contamination or Hazardous Substance-related nuisance on, under or from the Project Site or Agency Parcels, or any other physical condition on the Project Site or Agency Parcels, to the extent the Release, pollution, contamination, nuisance or physical condition occurred or existed prior to the Close of Escrow on Parcel A-1, except to the extent such violation, Release, pollution, contamination, nuisance or physical condition was caused or exacerbated by Tenant, its officers, employees, agents or others for whom Tenant is responsible. This release does not extend to obligations assumed by Tenant under this Agreement or any of its attachments or any rights of entry or any other agreements under which Tenant assumes responsibility for environmental physical conditions, as to which the Agency reserves its rights to enforce the agreements and to sue Tenant.

4.3 Easements.

(a) Agency hereby grants to Tenant the following easement and access rights:

(i) subject to (A) the terms and conditions of this Lease, (B) the Navy Utilities Agreement, (C) the rights of the public which may be granted by Agency at its sole discretion, (D) the requirements of the City's Environmental Ordinance for Parcel A, codified in Health Code Article 31, and (E) the use restrictions of Article 2 hereof, such non-exclusive easement(s) as may be reasonably necessary to effectuate the purposes of this Lease, the Navy Utilities Agreement, and/or the Utilities Agreement as defined in Section 5.4, including but not limited to sub-easements or other rights to use easements granted to Agency by the Navy.

(ii) at such time as the Lease terminates for a portion of the Premises pursuant to Section 1.2 herein, a non-exclusive easement limited in duration to the Term of this Lease, in and over certain areas (the "Access Easement") for purposes of pedestrian and vehicular access and ingress and egress in connection with the use of the Premises under this Lease. In connection with any agreement to terminate a portion of the Premises under this Lease (the "Partial Termination Agreement"), the Parties agree to establish the boundaries of the Access Easement area and attach the description of its boundaries to this Lease.

(b) Agency reserves the right to use, or permit others to use, the easements in common with Tenant, provided such use does not interfere with Tenant's use hereunder and further provided that in the event there is any conflict regarding the Navy's use of such easements pursuant to the Navy Utilities Agreement, the Navy Utilities Agreement shall prevail. For purposes of this Lease, the "Premises" shall be deemed to include the easements, except that Tenant's maintenance and indemnification obligations therefor and Permitted Uses therein shall be as set forth in this Lease (including, without limitation, Articles 2, 9, 12 and Section 10.2 hereof).

4.4 Subsurface Mineral Rights.

Agency and Tenant acknowledge that, pursuant to the Hunters Point Shipyard Conversion Act of 2002 (Ch. 464, Statutes 2002), Agency owns and holds in trust a portion of the Premises shown in Exhibit B (the "State Lands Parcel"). Under the terms and conditions thereof, the State of California (the "State") has reserved all subsurface mineral deposits, including oil and gas deposits on or underlying the Premises, including the right to explore, drill for and extract such subsurface minerals, including oil and gas deposits, solely from a single point of entry outside of the Premises, provided that such right shall not be exercised so as to disturb or otherwise interfere with Tenant's Leasehold Estate, but provided further, that, without limiting any remedies the Parties may have against the State or other parties, any such disturbance or interference that causes damage or destruction to the Premises will be governed under Article 12 hereunder. Agency shall have no liability under this Lease arising out of any exercise by the State of such mineral rights (unless the State has succeeded to Agency's interest under this Lease, in which case such successor owner may have such liability).

ARTICLE 5. LEASEHOLD IMPROVEMENTS AND ALTERATIONS.

5.1 Title to Improvements.

During the Term of this Lease, Agency shall own all of the Improvements, including all existing Improvements and future Improvements (except for trade fixtures and other personal property of Subtenants). Tenant and its Subtenants shall have the right at any time, or from time to time, including, without limitation, at the expiration or upon the earlier termination of the Term of this Lease, to remove Personal Property from the Premises; provided, however, that if the removal of Personal Property causes material damage to the Premises, Tenant shall promptly cause the repair of such damage at no cost to Agency.

5.2 Agency's Right to Approve Construction.

(a) Construction Requiring Approval. Subject to the terms of this Article 5, Tenant may perform from time to time during the Term construction of the Minor Alterations and the Major Alterations (the "Construction").

(b) Permits. Tenant acknowledges that the provisions of this section are subject to Sections 6.1(a). In particular, Tenant acknowledges that Agency's approval of Construction does not alter Tenant's obligation to obtain all Regulatory Approvals and all permits required by applicable Law to be obtained from governmental agencies having jurisdiction, including, where applicable, from the Agency itself in its regulatory capacity.

5.3 Approval of Minor Alterations; Major Alterations.

Unless otherwise required under Section 5.2(a), Agency's approval hereunder shall not be required for (a) the installation, repair or replacement of furnishings, fixtures, equipment or decorative improvements which do not materially affect the structural integrity of the Improvements, (b) recarpeting, repainting the interior of the Premises, landscaping, or similar alterations, (c) the installation of tenant improvements and finishes to prepare portions of the

Premises for occupancy or use by Subtenants (provided that the foregoing shall not alter Tenant's and/or Subtenant's obligation to obtain any required Regulatory Approvals and permits, including, as applicable, a building permit from the Agency, acting in its regulatory capacity), or (d) any other Construction costing Two Hundred Fifty Thousand and no/100 Dollars (\$250,000.00) or less, as Indexed (collectively, "Minor Alterations"). All Construction costing in excess of Two Hundred Fifty Thousand and No/100 dollars (\$250,000) shall be referred to herein as "Major Alterations" and shall require the prior written approval of Agency, which shall not be unreasonably withheld or delayed.

5.4 Utility Services.

Tenant shall provide, maintain and operate utility services in accordance with the terms of Exhibit E-1 and Exhibit E-2, and if Agency determines that it is reasonably necessary, Tenant and Agency subsequently shall enter into a utilities agreement consistent with the standards set forth in Exhibits E-1 and E-2 (in form and substance acceptable to Agency in its sole and absolute discretion) relating to Tenant's arranging, at no cost or expense to Agency, for the provision and construction of certain on and off-site utilities necessary and appropriate to the uses and occupancy of the Premises (the "Utilities Agreement").

ARTICLE 6. REQUIRED MAINTENANCE AND REPAIR SERVICES.

6.1 Required Services.

(a) Baseline Services. Agency and Tenant agree that the Tenant shall provide to all of the Premises, and at no cost to the Agency, certain limited on-going site management, operations, security, fencing and grounds maintenance and repair services more particularly described in Exhibit E-1 attached hereto (collectively, the "Baseline Services").

(b) Active Services. In addition, Tenant shall provide to the Active Premises ongoing Sublease management, operations, utilities, maintenance and repair services described in Exhibit E-2 (collectively, the "Active Services," which together with the Baseline Services are collectively referred to as the "Required Services").

6.2 [Reserved.]

6.3 No Obligation of Agency; Waiver of Rights. Tenant shall be solely responsible for the condition, operation, repair, maintenance and management of the Premises, including any and all Improvements, from and after the Commencement Date. Agency shall have no obligation to make repairs or replacements of any kind or maintain the Premises (including the Common Area, or any other Improvements) or any portion thereof. Without limiting the foregoing, Tenant hereby waives any right to make repairs at Agency's expense as may be provided by Sections 1932(1), 1941 and 1942 of the California Civil Code, as any such provisions may from time to time be amended, replaced, or restated.

6.4 Notice. Tenant shall deliver to Agency, promptly after receipt, a copy of any notice which Tenant may receive from time to time: (i) from any governmental authority (other than Agency) having responsibility for the enforcement of any applicable Laws (including

Disabled Access Laws or Hazardous Materials Laws), asserting that the Premises are in violation of such Laws; or (ii) from the insurance company issuing or responsible for administering one or more of the insurance policies required to be maintained by Tenant under Article 11, asserting that the requirements of such insurance policy or policies are not being met.

6.5 Security Services.

(a) Agency's Security Services Responsibilities. Subject to Section 6.5(b) below, Agency shall provide security protection services to the Project Area, including, without limitation, to the Premises, as described in the Security Cooperative Agreement, as it may be amended from time to time (the "Security Services").

(b) Tenant's Security Services Responsibilities.

(i) Tenant shall pay to Agency, as Additional Rent payable on the first day of each month during the Term commencing on the Commencement Date, Tenant's proportionate share of Agency's cost of providing such Security Services to the Premises. Such proportionate share shall be equal to (i) the square footage of the Premises (or such other pro-rata measurement designation used for Security Services charges under the Security Cooperative Agreement) multiplied by (ii) the cost per square foot (or such other measurement designation used for Security Services charges under the Security Cooperative Agreement) that Agency charges the Navy for Agency's performance of the Security Services, as more specifically set forth in the Security Cooperative Agreement ("Tenant's Proportionate Share of Security Services Costs"). If the Security Cooperative Agreement is amended, then Agency shall provide written notice of such amendment to Tenant promptly after such amendment becomes effective, which notice shall also state whether and by how much Tenant's Proportionate Share of Security Services Costs has increased or decreased. Tenant shall pay Tenant's Proportionate Share of Security Services Costs, increased or decreased by that amount set forth in Agency's most current written notice, on the next payment date following receipt of such written notice.

(ii) If Agency determines that it will no longer provide the Security Services to the Premises, Tenant must provide such Security Services to the Premises. Agency shall give Tenant no less than sixty (60) days prior written notice that Agency will cease to provide the Security Services and within that sixty (60) day period, Tenant shall select a security firm approved by Agency and enter into a contract approved by Agency with such firm. Agency shall also have the right to approve the security personnel who operate on the Premises. Tenant shall provide all Security Services in the manner required by the Security Cooperative Agreement and shall have the rights and obligations thereunder as if Tenant were the Agency, other than any reimbursement rights set forth therein. If Tenant is required to provide Security Services, Agency shall have the rights of the Navy with respect to the Security Services under the Security Cooperative Agreement.

ARTICLE 7. LIENS.

7.1 Liens.

Tenant shall not create or permit the attachment of, and shall promptly following notice, discharge at no cost to Agency, any lien, security interest, or encumbrance on the Premises, other than (i) this Lease or Permitted Subleases, (ii) liens for non-delinquent Impositions (excluding Impositions which may be separately assessed against the interests of Subtenants), except only for Impositions being contested as permitted by Article 8, (iii) liens of mechanics, material suppliers or vendors, or rights thereto, for sums which under the terms of the related contracts are not at the time due or which are being contested as permitted by this Article 7, (iv) any liens, security interests, or encumbrances existing as of the Effective Date, and (v) any liens, security interests, or encumbrances which were not created or permitted by Tenant or created by Agency. The provisions of this Article do not apply to liens created by Tenant on its Personal Property.

7.2 Mechanics' Liens.

Nothing in this Lease shall be deemed or construed in any way as constituting the request of Agency, express or implied, for the performance of any labor or the furnishing of any materials for any specific improvement, alteration or repair of or to the Premises or the Improvements, or any part thereof. Tenant agrees that at all times when the same may be necessary or desirable, Tenant shall take such action as may be reasonably required by Agency or under any Law in existence or hereafter enacted which will prevent the enforcement of any mechanics' or similar liens against the Premises, Tenant's Leasehold Estate, or Agency's fee interest in the Premises for or on account of labor, services or materials furnished to Tenant, or furnished at Tenant's request. If Tenant does not, within sixty (60) days following the Tenant's receipt of notice of the imposition of any such lien, cause the same to be released of record or post a bond or take such other action reasonably acceptable to Agency, it shall be a material default under this Lease, and Agency shall have, in addition to all other remedies provided by this Lease or by Law, the right but not the obligation to cause the same to be released by such means as it shall deem proper, including without limitation, payment of the claim giving rise to such lien. All sums paid by Agency for such purpose and all reasonable expenses incurred by Agency in connection therewith shall be payable to Agency by Tenant within thirty (30) days following written demand by Agency with supporting invoices.

7.3 No Mortgage.

Tenant shall not engage in any financing or other transaction creating any mortgage or deed of trust upon the Premises or upon Tenant's Leasehold Estate therein without Agency's prior written consent which may be withheld in Agency's sole and absolute discretion.

ARTICLE 8. TAXES AND ASSESSMENTS.

8.1 Payment of Possessory Interest Taxes and Other Impositions.

(a) Payment of Possessory Interest Taxes. Tenant shall pay or cause to be paid, prior to delinquency, all possessory interest and property taxes assessed, levied or imposed

on the Premises or any of the Improvements or Personal Property (excluding the personal property of any Subtenant whose interest is separately assessed) located on the Premises (but excluding any such taxes separately assessed, levied or imposed on any Subtenant), to the full extent of installments or amounts payable or arising during the Term (subject to the provisions of Section 8.1(c)). Subject to the provisions of Section 8.3 hereof, all such taxes shall be paid directly to the City's tax collector or other charging authority prior to delinquency, provided that if applicable Law permits Tenant to pay such taxes in installments, Tenant may elect to do so. In addition, Tenant shall pay any fine, penalty, interest or cost as may be charged or assessed for nonpayment or delinquent payment of such taxes. Tenant shall have the right to contest the validity, applicability or amount of any such taxes in accordance with Section 8.3.

(i) Acknowledgment of Possessory Interest. Tenant specifically recognizes that this Lease may create a possessory interest which is subject to taxation, and that this Lease requires Tenant to pay any and all possessory interest taxes levied upon Tenant's interest pursuant to an assessment lawfully made by the City's tax assessor. Tenant further acknowledges that any Sublease or assignment by Tenant permitted under this Lease and any exercise of any option to renew or extend this Lease may constitute a change in ownership, within the meaning of the California Revenue and Taxation Code, and therefore may result in a reassessment of any possessory interest created hereunder in accordance with applicable Law.

(ii) Reporting Requirements. San Francisco Administrative Code Sections 6.63-1, 6.63-2, 23.6-1 and 23.6-2 require that Agency report certain information relating to this Lease, and the creation, renewal, extension, assignment, sublease, or other transfer of any interest granted hereunder, to the County Assessor within sixty (60) days after any such transaction. Within thirty (30) days following the date of any transaction that is subject to such reporting requirements, Tenant shall provide such information as may reasonably be requested by Agency to enable Agency to comply with such requirements.

(b) Other Impositions. Without limiting the provisions of Section 8.1(a), and except as otherwise provided in this Section 8.1(b) and Section 8.3, Tenant shall pay or cause to be paid all Impositions (as defined below), to the full extent of installments or amounts payable or arising during the Term (subject to the provisions of Section 8.1(c)), which may be assessed, levied, confirmed or imposed on or in respect of or be a lien upon the Premises, any Improvements now or hereafter located thereon, any Personal Property now or hereafter located thereon (but excluding the personal property of any Subtenant whose interest is separately assessed), the Leasehold Estate created hereby, or any subleasehold estate permitted hereunder, including any taxable possessory interest which Tenant, any Subtenant or any other Person may have acquired pursuant to this Lease (but excluding any such Impositions separately assessed, levied or imposed on any Subtenant). Subject to the provisions of Section 8.3, Tenant shall pay all Impositions directly to the taxing authority, prior to delinquency, provided that if any applicable Law permits Tenant to pay any such Imposition in installments, Tenant may elect to do so. In addition, Tenant shall pay any fine, penalty, interest or cost as may be assessed for nonpayment or delinquent payment of any Imposition. As used herein, "Impositions" means all taxes, assessments, liens, levies, charges or expenses of every description, levied, assessed, confirmed or imposed on the Premises, any of the Improvements or Personal Property located on the Premises, Tenant's Leasehold Estate, any subleasehold estate, or any use or occupancy of the Premises hereunder. Impositions shall include all such taxes, assessments, fees and other

) charges whether general or special, ordinary or extraordinary, foreseen or unforeseen, or hereinafter levied or assessed in lieu of or in substitution of any of the foregoing of every character. The foregoing or subsequent provisions notwithstanding, Tenant shall not be responsible for any Impositions arising from or related to, the Agency's fee ownership interest in the Property or Premises, the Agency's interest as landlord under this Lease, or any transfer thereof, including but not limited to, Impositions relating to the fee, transfer taxes associated with the conveyance of the fee, or business or gross rental taxes attributable to Agency's fee interest or a transfer thereof.

(c) Prorations. All Impositions imposed for the tax years in which the Commencement Date occurs or during the tax year in which this Lease terminates shall be apportioned and prorated between Tenant and Agency on a daily basis.

(d) Proof of Compliance. Within ten (10) business days following Agency's written request which Agency may give at any time and give from time to time, Tenant shall deliver to Agency copies of official receipts of the appropriate taxing authorities, or other proof reasonably satisfactory to Agency, evidencing the timely payment of such Impositions.

8.2 Agency's Right to Pay.

) Unless Tenant is exercising its right to contest under and in accordance with the provisions of Section 8.3, if Tenant fails to pay and discharge any Impositions (including without limitation, fines, penalties and interest) prior to delinquency, Agency, at its sole option, may (but is not obligated to) pay or discharge the same, provided that prior to paying any such delinquent Imposition, Agency shall give Tenant written notice specifying a date at least ten (10) business days following the date such notice is given after which Agency intends to pay such Impositions. If Tenant fails, on or before the date specified in such notice, either to pay the delinquent Imposition or to notify Agency that it is contesting such Imposition pursuant to Section 8.3, then Agency may thereafter pay such Imposition, and the amount so paid by Agency (including any interest and penalties thereon paid by Agency), together with interest at the Default Rate computed from the date Agency makes such payment, shall be deemed to be and shall be payable by Tenant as Additional Rent, and Tenant shall reimburse such sums to Agency within ten (10) business days following demand.

8.3 Right of Tenant to Contest Impositions and Liens.

) Tenant shall have the right to contest the amount, validity or applicability, in whole or in part, of any Imposition or other lien, charge or encumbrance against or attaching to the Premises or any portion of, or interest in, the Premises, including any lien, charge or encumbrance arising from work performed or materials provided to Tenant or any Subtenant or other Person to improve the Premises or any portions of the Premises, by appropriate proceedings conducted in good faith and with due diligence, at no cost to Agency. Tenant shall give notice to Agency within ten (10) business days of the commencement of any such contest and of the final determination of such contest. Nothing in this Lease shall require Tenant to pay any Imposition as long as it contests the validity, applicability or amount of such Imposition in good faith, and so long as it does not allow the portion of the Premises affected by such Imposition to be forfeited to the entity levying such Imposition as a result of its nonpayment. If any Law requires,

) as a condition to such contest, that the disputed amount be paid under protest, or that a bond or similar security be provided, Tenant shall be responsible for complying with such condition as a condition to its right to contest. Tenant shall be responsible for the payment of any interest, penalties or other charges which may accrue as a result of any contest, and Tenant shall provide a statutory lien release bond or other security reasonably satisfactory to Agency in any instance where Agency's interest in the Premises may be subjected to such lien or claim. Tenant shall not be required to pay any Imposition or lien being so contested during the pendency of any such proceedings unless payment is required by the court, quasi-judicial body or administrative agency conducting such proceedings. If Agency is a necessary party with respect to any such contest, or if any Law now or hereafter in effect requires that such proceedings be brought by or in the name of Agency or any owner of the Premises, Agency, at the request of Tenant and at no cost to Agency, with counsel selected and engaged by Tenant, subject to Agency's reasonable approval, shall join in or initiate, as the case may be, any such proceeding. Agency, at its own expense and at its sole option, may elect to join in any such proceeding whether or not any Law now or hereafter in effect requires that such proceedings be brought by or in the name of Agency or any owner of the Premises. Except as provided in the preceding sentence, Agency shall not be subjected to any liability for the payment of any fines, penalties, costs, expenses or fees, including Attorneys' Fees and Costs, in connection with any such proceeding, and without limiting Article 17, Tenant shall Indemnify Agency for any such fines, penalties, costs, expenses or fees, including Attorneys' Fees and Costs, which Agency may be legally obligated to pay.

ARTICLE 9. COMPLIANCE WITH LAWS.

9.1 Compliance with Laws and Other Requirements.

) (a) Tenant's Obligation to Comply. During the Term of this Lease, Tenant shall comply, at no cost to Agency, (i) with all applicable Laws (including Regulatory Approvals), (ii) with all Mitigation Measures to the extent applicable to activities performed under this Lease, and (iii) with the requirements of all policies of insurance required to be maintained pursuant to Article 11 of this Lease. The foregoing sentence shall not be deemed to limit Agency's ability to act in its legislative or regulatory capacity, including the exercise of its police powers. In particular, Tenant acknowledges that the Permitted Uses under Section 2.1 do not limit Tenant's responsibility to obtain Regulatory Approvals for such uses, including but not limited to, building permits, nor do such uses limit Agency's responsibility in the issuance of any such Regulatory Approvals to comply with applicable Laws, including the California Environmental Quality Act. It is understood and agreed that Tenant's obligation to comply with Laws shall include the obligation to make, at no cost to Agency, all additions to, modifications of, and installations on the Premises that may be required by any Laws regulating the Premises, subject to the provisions of Section 5.2(b).

) (b) Unforeseen Requirements. The Parties acknowledge and agree that Tenant's obligation under this Section 9.1 to comply with all present or future Laws is a material part of the bargained-for consideration under this Lease. Tenant's obligation to comply with Laws may include, without limitation, the obligation to make substantial or structural repairs and alterations to the Premises (including, without limitation thereto, the Health and Safety Improvements) in order to occupy the Premises or, at Tenant's election, to convert any portion of

the Premises from Passive to Active Premises pursuant to Section 1.1(c) hereof. In the event Tenant declines to perform such repairs and alterations to any portion of the Premises, Tenant shall promptly notify Agency of Tenant's intent to convert such portion of the Premises to Passive Premises. Except as provided in Sections 1.1(c), 13, or 14, no occurrence or situation arising during the Term, nor any present or future Law, whether foreseen or unforeseen, and however extraordinary, shall relieve Tenant of its obligations hereunder, nor give Tenant any right to terminate this Lease in whole or in part or to otherwise seek redress against Agency.

(c) Proof of Compliance. Tenant shall promptly upon request provide Agency with evidence of its compliance with any of the obligations required under this Article.

9.2 Regulatory Approvals.

(a) Agency and City Approvals. Tenant understands and agrees that Agency is entering into this Lease in its proprietary capacity as the holder of fee title to the Premises for the public benefit, and not in its capacity as a regulatory agency. Tenant understands that the entry by the Agency into this Lease shall not be deemed to imply that Tenant will be able to obtain any required approvals from City departments, boards or commissions which have jurisdiction over the Premises, including the Agency itself in its regulatory capacity. By entering into this Lease, the Agency is in no way modifying Tenant's obligations to cause the Premises to be used and occupied in accordance with all Laws, as provided herein.

(b) Approval of Other Agencies. Tenant understands that Tenant's contemplated uses and activities on the Premises, any subsequent changes in permitted uses, and any alterations or Construction to the Premises, may require that approvals, authorizations or permits be obtained from governmental agencies with jurisdiction. Tenant shall be solely responsible for obtaining Regulatory Approvals as further provided in this Article. In any instance where Agency will be required to act as a co-permittee, or where Tenant proposes Construction which requires Agency's approval under Section 5.3, Tenant shall not apply for any Regulatory Approvals (other than building permits) without first obtaining the approval of Agency, which approval will not be unreasonably withheld, conditioned or delayed. Throughout the permit process for any Regulatory Approval, Tenant shall consult and coordinate with Agency in Tenant's efforts to obtain such Regulatory Approval, and Agency shall cooperate reasonably with Tenant in its efforts to obtain such Regulatory Approval. Agency shall have no obligation to make expenditures or incur expenses other than administrative expenses. However, Tenant shall not agree to the imposition of conditions or restrictions in connection with its efforts to obtain a permit from any other regulatory agency than Agency if the conditions or restrictions could create any substantial or material obligations (as determined by Agency in its reasonable discretion) on the part of Agency whether on or off the Premises, unless in each instance Agency has previously approved such conditions in writing in Agency's sole and absolute discretion. No such approval by Agency shall limit Tenant's obligation to pay all the costs of complying with such conditions under this Article. Subject to the conditions of this Article, Agency shall join, where required, in any application by Tenant for a required Regulatory Approval, and in executing such permit, provided that Agency shall have no obligation to join in any such application or execute the permit if the Agency does not approve the conditions imposed by the other regulatory agency under such permit as provided herein. All costs associated with applying for and obtaining any necessary Regulatory Approval shall be borne by Tenant. Tenant

shall be responsible for complying, at no cost to Agency or the City, with any and all conditions imposed by any regulatory agency as part of a Regulatory Approval. With the consent of Agency (which shall not be unreasonably withheld or delayed), Tenant shall have the right to appeal or contest in any manner permitted by Law any condition imposed upon any such Regulatory Approval. Tenant shall pay and discharge any fines, penalties or corrective actions imposed as a result of the failure of Tenant to comply with the terms and conditions of any Regulatory Approval and Agency shall have no liability for such fines and penalties except to the extent that such failure results solely from the willful misconduct or gross negligence of Agency. Without limiting the indemnification provisions of Article 12, Tenant shall Indemnify the Indemnified Parties from and against any and all such fines and penalties, together with Attorneys' Fees and Costs, for which Agency may be liable in connection with Tenant's failure to comply with any Regulatory Approval.

ARTICLE 10. HAZARDOUS MATERIALS.

10.1 Hazardous Materials Compliance.

(a) Compliance with Hazardous Materials Laws. Tenant shall comply and cause (i) its Agents, (ii) all Persons under any Sublease, (iii) to the extent reasonably controllable by Tenant, all Invitees or other Persons entering upon the Premises, and (iv) the Premises and the Improvements, to comply with all Hazardous Materials Laws and prudent business practices, including, without limitation, any deed restrictions, deed notices, soils management plans or certification reports required in connection with the approvals of any regulatory agencies in connection with any Improvements; provided that, notwithstanding any other provision of this Lease, Tenant shall not be obligated to remediate the presence of any Hazardous Materials conditions existing in or on the Premises prior to the Effective Date except to the extent that Tenant or its Agents disturb or exacerbates such pre-existing conditions or to the extent that the Handling or Remediation of such pre-existing Hazardous Materials is required by Regulatory Agencies having jurisdiction as a result of activities or uses of the Premises permitted or conducted by Tenant, its Subtenants, Agents or Invitees. Without limiting the generality of the foregoing, Tenant covenants and agrees that it will not, without the prior written consent of Agency, which may be given or withheld in Agency's sole discretion, Handle, nor will it permit the Handling of Hazardous Materials on, under or about the Premises, except for (A) standard building materials and equipment that do not contain asbestos or asbestos-containing materials, lead or polychlorinated biphenyl (PCBs); (B) gasoline and other fuel products used to transport and operate vehicles and equipment; (C) any Hazardous Materials that do not require a permit or license from, or that need not be reported to, a governmental agency, which Hazardous Materials are used in the construction of the Improvements, and which are reported to, and approved by Agency prior to any such Handling and, in any case, are used in strict compliance with all applicable laws; (D) janitorial or office supplies or materials in such limited amounts as are customarily used for general office purposes so long as such Handling is at all times in full compliance with all Environmental Laws; and (E) pre-existing Hazardous Materials that are required by Law or prudent business practices to be Handled for Remediation purposes.

(b) Notice. Except for Hazardous Materials permitted by Subsection 10.1(a) above, Tenant and Agency shall advise the other in writing promptly (but in any event within

five (5) business days) upon learning or receiving notice of (i) the presence of any Hazardous Materials on, under or about the Premises, (ii) any action taken by Tenant or Agency in response to any (A) Hazardous Materials on, under or about the Premises or (B) Hazardous Materials Claims, and (iii) Tenant's or Agency's discovery of the presence of Hazardous Materials on, under or about any real property adjoining the Premises. Tenant and Agency shall inform the other orally as soon as possible of any emergency or non-emergency regarding a Release or discovery of Hazardous Materials. In addition, Tenant and Agency shall provide each other with copies of all communications with federal, state and local governments or agencies relating to Hazardous Materials Laws (other than privileged communication, so long as any non-disclosure of such privileged communication does not otherwise result in any non-compliance by Tenant with the terms and provisions of this Article 10) and all communication with any Person relating to Hazardous Materials Claims (other than privileged communications; provided, however, such non-disclosure of such privileged communication shall not limit or impair Tenant's obligation to otherwise comply with each of the terms and provisions of this Lease, including without limitation, this Article 10).

(c) Agency's Approval of Remediation. Except as required by Law or to respond to an emergency, Tenant shall not take any Remediation in response to the presence, Handling, transportation or Release of any Hazardous Materials on, under or about the Premises unless Tenant shall have first submitted to Agency for Agency's approval, which approval shall not be unreasonably withheld, conditioned or delayed, a written Hazardous Materials Remediation plan and the name of the proposed contractor which will perform the work. Agency shall approve or disapprove of such Hazardous Materials Remediation plan and the proposed contractor promptly, but in any event within thirty (30) days after receipt thereof. If Agency disapproves of any such Hazardous Materials Remediation plan, Agency shall specify in writing the reasons for its disapproval. Any such Remediation undertaken by Tenant shall be done in a manner so as to minimize any impairment to the Premises to the extent reasonably possible. In the event Tenant undertakes any Remediation with respect to any Hazardous Materials on, under or about the Premises, Tenant shall conduct and complete such Remediation (x) in compliance with all applicable Hazardous Materials Laws, (y) to the reasonable satisfaction of the Agency, and (z) in accordance with the orders and directives of all federal, state and local governmental authorities, including but not limited to, the United States Environmental Protection Agency, the California Department of Toxic Substances Control, the Regional Water Quality Control Board and the San Francisco Department of Public Health.

(d) Pesticide Prohibition. Tenant shall comply with the City's Pesticide Ordinance, set forth in the provisions of Section 39.9 of Chapter 39 of the San Francisco Administrative Code. Pursuant to Section 39.9, Tenant shall (i) prohibit the use of certain pesticides on Agency property, (ii) require the posting of certain notices and the maintenance of certain records regarding pesticide usage, and (iii) submit to Agency an integrated pest management plan that (a) lists, to the extent reasonably possible, the types and estimated quantities of pesticides that Tenant may need to apply to the Premises during the Term of this Lease, (b) describes the steps Tenant will take to meet the City's integrated pest management policy described in Section 39.1 of the Pesticide Ordinance, and (c) identifies, by name, title, address and telephone number, an individual to act as the Tenant's primary integrated pest management contact person with Agency. In addition, Tenant shall comply with the requirements of Section 39.4 of the Pesticide Ordinance. Nothing shall prevent Tenant, acting

through the Agency, from seeking a determination of Exemption from the City's Commission on the Environment from compliance with certain Portions of the Pesticide Ordinance as provided in Section 39.8 thereof.

10.2 Hazardous Materials Indemnity.

Without limiting the indemnity in Section 12.1, Tenant shall Indemnify the Indemnified Parties from and against any and all Losses which arise out of or relate in any way to any use, Handling, production, transportation, disposal, storage or Release of any Hazardous Materials in or on the Premises at any time during the Term of the Lease and before the surrender of the Premises by Tenant, whether by Tenant, any Subtenants or any other Person (other than Agency and its Agents and Invitees) directly or indirectly arising out of (A) the Handling, transportation or Release of Hazardous Materials by Tenant, its Agents, Invitees or any Subtenants or any Person on or about the Premises (other than Agency and its Agents and Invitees), (B) any failure by Tenant, its Agents, Invitees or Subtenants (other than Agency and its Agents and Invitees) to comply with Hazardous Materials Laws, or (C) any failure by Tenant to comply with the obligations contained in Section 12.1. All such Losses within the scope of this Section shall constitute Additional Rent owing from Tenant to Agency hereunder and shall be due and payable from time to time immediately upon Agency's request, as incurred. Tenant understands and agrees that its liability to the Indemnified Parties shall arise upon the earlier to occur of (a) discovery of any such Hazardous Materials on, under or about the Premises or the discovery of the disturbance or exacerbation of the pre-existing condition, or (b) the institution of any Hazardous Materials Claim with respect to such Hazardous Materials, and not upon the realization of loss or damage. Notwithstanding the foregoing, Tenant's indemnity hereunder with respect to any and all Losses occurring from activities on the Access Easement and arising out of the acts or omissions described in (A)-(C) of this Section 10.2 (i) shall be limited to Losses arising directly or indirectly from the wrongful acts or negligent omissions of Tenant or any of its Agents or Subtenants (but not acts or omissions of Invitees to the extent not related to acts or omissions of Tenant or any of its Agents or Subtenants) and (ii) shall except and exclude any Losses arising from Hazardous Materials located in, on or under the Premises prior to the Effective Date of this Lease except to the extent that Tenant or its Agents disturbs or exacerbates such pre-existing conditions or to the extent that the Handling or Remediation of such preexisting Hazardous Materials is required by Regulatory Agencies having jurisdiction as a result of activities or uses of the Premises permitted or conducted by Tenant, its Subtenants, Agents or Invitees.

ARTICLE 11. INSURANCE.

11.1 Required Types and Amounts of Insurance Coverage.

(a) Required Insurance. To the extent not already maintained by Tenant pursuant to the DDA, Tenant shall, at no cost to Agency, obtain, maintain and cause to be in effect at all times from the Commencement Date to the later of (i) the last day of the Term, or (ii) the last day Tenant (A) is in possession of the Premises or (B) has the right of possession of the Premises (except as otherwise specified in this Section 11.1(a)), the types, including, without limitation, environmental insurance, and amounts of insurance as more particularly set forth in

Exhibit F attached hereto and such other insurance as is reasonably requested by Agency's Risk Manager to the extent such insurance is customary against claims for injuries to persons or damage to property that may arise from or in connection with the Required Services by Tenant, its representatives, agents, employees, consultants, contractors, subcontractors or joint venture partners, if any. Any deductibles with respect to the above insurance policies shall be as set forth in Exhibit F.

(b) General Requirements. All insurance provided for pursuant to this Article:

(i) Shall be carried under a valid and enforceable policy or policies issued by insurers of recognized responsibility that are rated Best A—:VI or better (or a comparable successor rating) and legally authorized to sell such insurance within the State of California; and

(ii) As to property insurance shall name the Agency as loss payee as its interest may appear, and as to both property and general liability insurance shall name as additional insureds the following: "THE CITY AND COUNTY OF SAN FRANCISCO AND THE SAN FRANCISCO REDEVELOPMENT AGENCY AND THEIR OFFICERS, DIRECTORS, EMPLOYEES AND AGENTS."

(c) Certificates of Insurance; Right of Agency to Maintain Insurance. Tenant shall furnish Agency certificates with respect to the policies required under this Article, and, upon Agency's request, shall also provide Agency with copies of each such policy or shall otherwise make such policy available to Agency for its review and evidence of payment of premiums, within thirty (30) days after the Commencement Date and, with respect to renewal policies, at least ten (10) business days prior to the expiration date of each such policy. If at any time Tenant fails to maintain the insurance required pursuant to Section 11.1, or fails to deliver certificates or policies as required pursuant to this Section, then, upon five (5) business days' written notice to Tenant, Agency may obtain and cause to be maintained in effect such insurance by taking out policies with companies satisfactory to Agency. Within ten (10) business days following demand, Tenant shall reimburse Agency for all amounts so paid by Agency, together with all costs and expenses in connection therewith and interest thereon at the Default Rate.

(d) Insurance of Others. If Tenant requires liability insurance policies to be maintained by Subtenants, contractors, subcontractors or others in connection with their use or occupancy of, or their activities on, the Premises, Tenant shall require that such policies include Tenant and Agency as additional insureds, as their respective interests may appear.

11.2 Agency Entitled to Participate.

With respect to property insurance, Agency shall be entitled to participate in and consent to any settlement, compromise or agreement with respect to any claim for any loss in excess of Five Million and No/100 Dollars (\$5,000,000.00) covered by the insurance required to be carried hereunder; provided, however, that (i) Agency's consent shall not be unreasonably withheld, and (ii) no consent of Agency shall be required in connection with any such settlement, compromise

or agreement concerning damage to all or any portion of the Improvements if Tenant shall have agreed in writing to commence and complete Restoration.

ARTICLE 12. INDEMNIFICATION OF AGENCY.

12.1 Indemnification of Agency.

Tenant agrees to and shall Indemnify the Indemnified Parties from and against any and all Losses imposed upon or incurred by or asserted against any such Indemnified Party, the Premises or Agency's interest therein, in connection with the occurrence or existence of any of the following: (i) any accident, injury to or death of Persons or loss of or damage to property occurring on the Premises, or any parts thereof; (ii) any accident, injury to or death of Persons or loss or damage to property occurring on the Premises which is caused directly or indirectly by Tenant or any of its Agents, Invitees, or Subtenants; (iii) any accident, injury or death of Persons or loss or damage to property occurring on the Access Easement which is caused directly or indirectly by Tenant or any of its Agents or Subtenants, or any use, possession, occupation, operation, maintenance, or management of the Access Easement by Tenant or any of its Agents or Subtenants; (iv) any use, possession, occupation, operation, maintenance, or management of the Premises or any part thereof by Tenant or any of its Agents, Invitees, or Subtenants; (v) any latent, design, construction or structural defect arising as a result of the Improvements or any subsequent Improvements constructed by or on behalf of Tenant, and any other matters relating to the condition of the Premises, or the Access Easement caused by Tenant or any of its Agents, or Subtenants; (vi) any failure on the part of Tenant or its Agents or Subtenants, as applicable, to perform or comply with any of the terms of this Lease or with applicable Laws, rules or regulations, or permits; (vii) performance of any labor or services or the furnishing of any materials or other property in respect of the Premises, or any part thereof by Tenant or any of its Agents or Subtenants; (viii) any civil rights actions or other legal actions or suits initiated by any user or occupant of the Premises, or the Access Easement to the extent it relates to such use or occupancy, in each of the foregoing instances, except (as to any particular Indemnified Party) to the extent caused by the willful misconduct or active negligence of that Indemnified Party. If any action, suit or proceeding is brought against any Indemnified Party by reason of any occurrence for which Tenant is obliged to Indemnify such Indemnified Party, such Indemnified Party will notify Tenant of such action, suit or proceeding. Tenant may, and upon the request of such Indemnified Party will, at Tenant's sole expense, resist and defend such action, suit or proceeding, or cause the same to be resisted and defended by counsel designated by Tenant and reasonably approved by such Indemnified Party in writing.

12.2 Immediate Obligation to Defend.

Tenant specifically acknowledges that it has an immediate and independent obligation to defend the Indemnified Parties from any claim which is actually or potentially within the scope of the indemnity provision of Section 12.1 or any other indemnity provision under this Lease, even if such allegation is or may be groundless, fraudulent or false, and such obligation arises at the time such claim is tendered to Tenant by an Indemnified Party and continues at all times thereafter; provided, however, that in the event of a final judgment or arbitration decision determining that all or a portion of the claim fell outside the scope of the indemnity, the Agency

shall reimburse Tenant for that portion of costs, fees and expenses expended by Tenant hereunder that was determined to be outside the scope of this indemnity.

12.3 Not Limited by Insurance.

The insurance requirements and other provisions of this Lease shall not limit Tenant's indemnification obligations under Section 12.1 or any other indemnification provision of this Lease.

12.4 Survival.

Tenant's obligations under this Article 12 and any other indemnity in this Lease shall survive the expiration or sooner termination of this Lease.

12.5 Other Obligations.

The agreements to Indemnify set forth in Article 12 and elsewhere in this Lease are in addition to, and in no way shall be construed to limit or replace, any other obligations or liabilities which Tenant may have to Agency in this Lease, at common law or otherwise.

12.6 Defense.

Tenant shall, at its option but subject to the reasonable consent and approval of Agency, be entitled to control the defense, compromise, or settlement of any such matter through counsel of Tenant's own choice; provided, however, in all cases Agency shall be entitled to participate in such defense, compromise, or settlement at its own expense. If Tenant shall fail, however, in Agency's reasonable judgment, within a reasonable time following notice from Agency alleging such failure, to take reasonable and appropriate action to defend, compromise, or settle such suit or claim, Agency shall have the right promptly to use the Agency's General Counsel or hire outside counsel, at Tenant's sole expense, to carry out such defense, compromise, or settlement, which expense shall be due and payable to Agency thirty (30) days after receipt by Tenant of an invoice therefor.

12.7 Release of Claims Against Agency.

Tenant, as a material part of the consideration of this Lease, hereby waives and releases any and all claims against the Indemnified Parties from any Losses, including damages to goods, wares, goodwill, merchandise, equipment or business opportunities and by Persons in, upon or about the Premises for any cause arising at any time, including, without limitation, all claims arising from the joint or concurrent negligence of Agency or the other Indemnified Parties, but excluding any active negligence or willful misconduct of the Indemnified Parties, or claims for which Agency has otherwise agreed to indemnify Tenant hereunder, and further excluding any claims, demands, or causes of action Tenant may now or hereafter have against the Agency for rights of contribution or equitable indemnity under applicable Laws arising from third party claims, including those arising under any leases at the Premises, relating to the period prior to the Effective Date of this Lease to the extent not otherwise released by Tenant under the ENA.

ARTICLE 13. DAMAGE OR DESTRUCTION.

13.1 General; Notice; Waiver.

(a) General. If at any time during the Term any damage or destruction occurs to all or any portion of the Premises, including the Improvements thereon, and including, but not limited to, any Significant Damage and Destruction, the rights and obligations of the Parties shall be as set forth in this Article.

(b) Notice. If there is any damage to or destruction of the Premises or of the Improvements thereon or any part thereof, which could materially impair use or operation of any Portions of the Improvements for their intended purposes for a period of thirty (30) days or longer, or Tenant shall promptly, but not more than ten (10) days after the occurrence of any such damage or destruction, give written notice thereof to Agency describing with as much specificity as is reasonable, given the ten-day time constraint, the nature and extent of such damage or destruction; provided, however, that Tenant shall provide Agency with a supplemental and more detailed written report describing such matters with specificity within thirty (30) days after the occurrence of the damage or destruction.

(c) Waiver. The Parties intend that this Lease fully govern all of their rights and obligations in the event of any damage or destruction of the Premises. Accordingly, Agency and Tenant each hereby waive the provisions of Sections 1932(2) and 1933(4) of the California Civil Code, as such sections may from time to time be amended, replaced, or restated.

13.2 Rent after Damage or Destruction.

If there is any damage to or destruction of the Premises, including the Improvements thereon, this Lease shall not terminate. In the event of any damage or destruction to the Improvements that does not result in a termination of this Lease, and at all times before completion of Restoration, Tenant shall pay to Agency all Rent at the times and in the manner described in this Lease.

13.3 Tenant's Obligation/Election to Restore.

Subject to Tenant's right to not Restore the Artists' Spaces pursuant to Section 13.4, if all or any portion of the Improvements that comprise the Artists' Spaces are damaged or destroyed, Tenant shall Restore such Improvements in accordance with the terms of this Section. If all or any portion of the other Improvements are damaged or destroyed, Tenant shall have the right (but shall not be obligated) to convert such Improvements from Active Premises to Passive Premises pursuant to Section 1.1(c) hereof and such election shall not terminate this Lease. In the event that Tenant is required to (with respect to the Artists' Spaces) or elects (with respect to the remainder of the Premises) to maintain the Improvements as Active Premises and to Restore the damage or destruction to the Premises, Tenant shall, subject to Section 13.4 hereof, within a reasonable period of time (allowing for securing necessary Regulatory Approvals), commence and diligently, subject to Force Majeure, Restore the Improvements to the condition they were in immediately before such damage or destruction, to the extent possible in accordance with then applicable Laws (including, but not limited to, any required code upgrades), without regard to the amount or availability of insurance proceeds. All Restoration performed by Tenant shall be

in accordance with the mutually agreeable construction procedures and shall be without cost to Agency. If insurance proceeds are available for such Restoration and Tenant is obligated or elects under this Section 13.3 to Restore, or elects to Restore in accordance with the provisions of Section 13.4, then Tenant shall have the sole right to negotiate an insurance settlement for claims of Three Million Dollars (\$3,000,000.00) or less, provided however, that Tenant shall use commercially reasonable efforts to insure that such settlement does not materially interfere with or delay Tenant's obligation and ability to pay Rent to Agency or otherwise meet its obligations hereunder. Agency and Tenant shall have the right to participate jointly in the settlement or compromise of any insurance claims in excess of Three Million Dollars (\$3,000,000.00).

13.4 Significant Damage and Destruction or Uninsured Casualty.

(a) Tenant's Election to Restore or Convert Premises.

(i) Uninsured Casualty. If an Uninsured Casualty occurs at any time during the Term, then at the time Tenant provides Agency with the ninety (90) day report described in Section 13.1(b) above, Tenant shall also provide Agency with written notice (the "Casualty Notice") either (1) electing to commence and complete Restoration of the Improvements; or (2) electing to convert that portion of the Premises from Active to Passive Premises or to have Passive Premises remain Passive Premises. For purposes hereof, "Uninsured Casualty" will mean either (i) if such event of damage or destruction is not required to be covered by insurance as set forth in Section 11.1(a)(ii), an event of damage or destruction occurring at any time during the Term for which the costs of Restoration (including the cost of any required code upgrades) exceeds Five Hundred Thousand and No/100 Dollars (\$500,000.00), as Indexed, or (ii) if such damage or destruction is required to be covered by insurance under Section 11.1(a)(ii), an event of damage or destruction occurring at any time during the Term for which the costs of Restoration (including the cost of any required code upgrades) will exceed the net proceeds of any insurance payable under the policies of insurance that Tenant is required to carry under Article 11 hereof (or which would have been payable but for Tenant's default in its obligation to maintain such insurance) by more than Five Hundred Thousand and No/100 Dollars, plus the amount of any applicable policy deductible (except in the case of damage or destruction caused by earthquake or flood, the amount of the policy deductible shall be deemed to be the lesser of the amount of the policy deductible under Tenant's property insurance policy maintained under Section 11.1(a)(ii) hereof as of the date of casualty, or the actual amount of the policy deductible). Tenant shall provide Agency with the Casualty Notice no later than the earlier to occur of the date that is ninety (90) days following the occurrence of such Significant Damage or Destruction or Uninsured Casualty. Except in the case of Uninsured Casualty, as a condition to making such election, Tenant shall pay or cause to be paid to Agency the proceeds of the rental interruption or business interruption insurance required hereunder arising out of or in connection with the casualty causing such Significant Damage or Destruction to the extent attributable to the Percentage Rent payable to Agency under this Lease for the duration of such event of Significant Damage or Destruction.

(ii) Other Circumstances Allowing Conversion. Notwithstanding the foregoing or subsequent provisions of this Article 13, Tenant shall not be required to Restore the Improvements and may elect to convert the Active Premises to Passive Premises in accordance with this Article 13 if the then existing Laws would not allow Tenant to Restore the

Improvements. If Tenant elects to convert based on either of the immediately foregoing determinations and Agency reasonably disputes Tenant's determination, Agency may submit the matter to arbitration, as set forth in Section 19.5 hereof (except that the estimators or arbitrators used for this purpose shall have at least ten (10) years' experience in major construction projects and commercial real estate projects in San Francisco).

13.5 Tenant's Election Not to Restore.

(a) In the event that Tenant elects not to Restore such Improvements pursuant to the terms of this Lease, and where not already Passive Premises, to convert such Improvements from Active Premises to Passive Premises, Tenant shall do all of the following:

(i) state, in Tenant's election to convert described in Section 13.4(a), the cost of Restoration, and the amount by which the cost of Restoration plus the amount of any applicable policy deductible (subject to the limitations on the policy deductible for damage or destruction caused by earthquake or flood as set forth in Section 13.4(a)(i) above) exceeds insurance proceeds payable (or those insurance proceeds which would have been payable but for Tenant's default in its obligation to maintain insurance required to be maintained hereunder);

(ii) shall pay or cause to be paid the following amounts from casualty insurance proceeds upon the later of making the election to convert Premises or promptly following receipt of such proceeds in the following order of priority:

(A) first, to Agency (or Tenant, if such work is performed by, or on account of, Tenant at its cost) for the actual costs incurred for any work required to alleviate any conditions caused by such event of damage or destruction that could cause an immediate or imminent threat to the public safety and welfare or damage to the environment, including without limitation, any demolition or hauling of rubble or debris;

(B) second, to Agency, which portions is an amount equal to all accrued and unpaid Minimum Rent owed by Tenant to Agency under this Lease as of the date of the occurrence of the event of damage or destruction;

(C) third, to Agency in the amount owed to Agency, if any, by Tenant on account of Tenant's obligations hereunder as of the date of the event of damage or destruction not otherwise paid to Agency under 13.5(a)(ii)(B);

(D) fourth, to any holder of a mortgage or deed of trust permitted hereunder; and

(E) fifth, the balance to Tenant.

(iii) terminate all Subleases relating to, and cause all Subtenants to vacate, any Subleased Premises that Tenant elects not to Restore; and

(iv) perform all Baseline Services that Agency determines are necessary to secure and make the converted Premises safe from "attractive nuisance" liability.

(b) Agency's Election to Recapture Space Upon Notice of Conversion of Premises. Notwithstanding the foregoing, if Tenant elects to convert Artists' Spaces from Active Premises to Passive Premises solely due to an Uninsured Casualty under circumstances permitted by Section 13.4(a) then Agency may, by notice in writing given to Tenant within sixty (60) days after Tenant's Casualty Notice, elect to delete such Artists' Spaces from the Premises leased to Tenant hereunder.

13.6 No Release of Tenant's Obligations.

No damage to or destruction of the Premises or Improvements or any part thereof for fire or any other cause shall permit Tenant to surrender this Lease or relieve Tenant from any obligations, including, but not limited to, the obligation to pay Rent, except as otherwise expressly provided herein.

ARTICLE 14. CONDEMNATION.

14.1 General; Notice; Waiver.

(a) General. If, at any time during the Term, there is any Condemnation of all or any part of the Premises, including any of the Improvements, the rights and obligations of the Parties shall be determined pursuant to this Article 14.

(b) Notice. In case of the commencement of any proceedings or negotiations which might result in a Condemnation of all or any portion of the Premises during the Term, the Party learning of such proceedings shall promptly give written notice of such proceedings or negotiations to the other Party. Such notice shall describe with as much specificity as is reasonable, the nature and extent of such Condemnation or the nature of such proceedings or negotiations and of the Condemnation which might result therefrom, as the case may be.

(c) Waiver. Except as otherwise provided in this Article 14, the Parties intend that the provisions of this Lease shall govern their respective rights and obligations in the event of a Condemnation. Accordingly, but without limiting any right to convert Premises given Tenant in this Article 14, Tenant waives any right to terminate this Lease upon the occurrence of a Partial Condemnation under Sections 1265.120 and 1265.130 of the California Code of Civil Procedure, as such section may from time to time be amended, replaced or restated.

14.2 Total Condemnation.

If there is a Condemnation of the entire Premises or Tenant's leasehold interest therein (a "Total Condemnation"), this Lease shall terminate as of the Condemnation Date.

14.3 Substantial Condemnation, Partial Condemnation.

If there is a Condemnation of any portion but less than all of the Premises, the rights and obligations of the Parties shall be as follows:

(a) Substantial Condemnation. If there is a Substantial Condemnation of a portion of the Premises, this Lease shall terminate, at Agency's or Tenant's option, as of the Condemnation Date, as further provided below. For purposes of this Article 14, a Condemnation of (i) less than the entire Premises, or (ii) property located outside the Premises that substantially and materially eliminates access to the Premises where no alternative access can be constructed or made available, shall be a Substantial Condemnation, and this Lease shall terminate (which shall be exercised, if at all, at any time within ninety (90) days after the Condemnation Date by delivering written notice of termination to the other Party) if a Party reasonably determines that such Condemnation renders the Premises untenable, unsuitable or economically infeasible for its intended use consistent with this Lease.

In the event the condition rendering the Premises, unsuitable, untenable, or economically unfeasible for its intended use consistent with this Lease can be cured by the performance of Restoration, Agency and Tenant agree to meet and confer for the purpose of reaching an agreement with respect to such Restoration and any other related issues which may be necessary or appropriate for resolution in connection with such work and the payment for such work. If no satisfactory agreement is reached within the 90-day period prescribed in this paragraph, such Condemnation shall be deemed a Substantial Condemnation.

(b) Partial Condemnation. If there is a Condemnation of any portion of the Premises which does not result in a termination of this Lease under Section 14.2 or Section 14.3(a) (a "Partial Condemnation"), this Lease shall terminate only as to the portion of the Premises taken in such Partial Condemnation, effective as of the Condemnation Date. In the case of a Partial Condemnation, or in the case of a Substantial Condemnation which does not result in a termination of this Lease, the Minimum Rent for the remainder of the Premises shall be adjusted in an equitable amount to reflect the diminution in value of the remaining portion of the Premises as of the Condemnation Date. Such Minimum Rent adjustment shall be separately computed with respect to (i) the temporary period during which any necessary Restoration will be performed; and (ii) the period following completion of any necessary Restoration. The Parties shall first negotiate in good faith in an attempt to determine by agreement the appropriate adjustment. If the Parties do not reach agreement within thirty (30) days following the Condemnation Date, the adjustment(s) shall be arbitrated, at the election of either Party, pursuant to Section 19.5 hereof (except that the estimators or arbitrators used for this purpose shall have at least ten (10) years experience in major construction projects and commercial real estate projects in San Francisco), and thereafter, either Party may elect to submit the final determination thereof to the same court of law that establishes the Condemnation Award. In the case of a Partial Condemnation, this Lease shall remain in full force and effect as to the portion of the Premises (or of Tenant's Leasehold Estate) remaining immediately after such Condemnation, and Tenant shall promptly commence and complete, subject to events of Force Majeure, any necessary Restoration of the remaining portion of the Premises, at no cost to Agency. Subject to the foregoing, any such Restoration shall be performed as the Parties shall reasonably agree.

14.4 Condemnation Awards.

Except as provided in Section 14.1(a) and in Sections 14.5 and 14.6, Condemnation Awards and other payments to either Agency or Tenant, less costs, fees and expenses of either Agency or Tenant (including, without limitation, reasonable Attorneys' Fees and Costs) incurred

in the collection thereof ("Net Awards and Payments") shall be allocated between Agency and Tenant as follows:

(a) In the event of a Partial Condemnation, first, to pay costs of Restoration incurred by Tenant, in which case, the portion of the Net Awards and Payments allocable to Restoration shall be payable to Tenant.

(b) Second, to the Agency for the value of the Premises (including the Property);

(c) Notwithstanding anything to the contrary set forth above, any portion of the Net Awards and Payments which has been specifically designated by the condemning authority or in the judgment of any court to be payable to Tenant for relocation, personal property or goodwill shall be paid to Tenant, as applicable, as so designated by the condemning authority or judgment.

14.5 Temporary Condemnation.

If there is a Condemnation of all or any portion of the Premises for a temporary period lasting less than the remaining Term of this Lease, other than in connection with a Substantial Condemnation or a Partial Condemnation of a portion of the Premises for the remainder of the Term, this Lease shall remain in full force and effect, there shall be no abatement of Rent, and the entire Condemnation Award shall be payable to Tenant.

14.6 Relocation Benefits, Personal Property.

Notwithstanding Section 14.4, Agency shall not be entitled to any portion of any Net Awards and Payments payable in connection with the Condemnation of the Personal Property of Tenant or any of its Subtenants.

ARTICLE 15. ASSIGNMENT AND SUBLETTING.

15.1 Assignment.

(a) Prohibited Without Consent of Agency. Tenant, its successors and permitted assigns shall not (i) suffer or permit any Significant Change to occur, or (ii) transfer or assign any interest in this Lease either voluntarily or by operation of law, without the prior written consent of Agency, which consent may be withheld by Agency in its sole discretion. In the event of a breach of this provision, this Lease will terminate immediately without necessity of notice or other action and the Agency shall have full and immediate rights of re-entry and possession of the Premises.

(b) Conditions. Any transfer of the Lease described in Subsection (a) is further subject to the satisfaction of the following conditions precedent, each of which is hereby agreed to be reasonable as of the date hereof:

(i) any proposed transferee, by instrument in writing, for itself and its successors and assigns, and expressly for the benefit of Agency, must expressly assume all of the obligations of Tenant under this Lease, and any other agreements or documents entered into by and between Agency and Tenant relating to the Premises or the Project Area, and must agree to be subject to all of the conditions and restrictions to which Tenant is subject. It is the intent of this Lease, to the fullest extent permitted by Law and equity and excepting only in the manner and to the extent specifically provided otherwise in this Lease, that no transfer of this Lease, or any interest therein, however consummated or occurring, and whether voluntary or involuntary, may operate, legally or practically, to deprive or limit Agency of or with respect to any rights or remedies or controls provided in or resulting from this Lease with respect to the Premises and the construction of the Improvements that Agency would have had, had there been no such transfer or change;

(ii) all instruments and other legal documents involved in effecting the transfer shall have been submitted to Agency for review, including the agreement of sale, transfer, or equivalent, and Agency shall have approved such documents which approval may be withheld or delayed in Agency's sole and absolute discretion.

(iii) Tenant shall have complied with the provisions of Subsection (d) of this Section 15.1;

(iv) there shall be no Event of Default or Unmatured Event of Default on the part of Tenant under this Lease or any of the other documents or obligations to be assigned to the proposed transferee, or if not cured, Tenant or the proposed transferee have made provisions to cure of the Event of Default, which provisions are satisfactory to Agency in its sole discretion;

(v) the proposed transferee (A) has demonstrated to Agency's reasonable satisfaction that it is capable, financially and otherwise, of performing each of Tenant's obligations under this Lease and any other documents to be assigned, and (B) is subject to the jurisdiction of the courts of the State of California;

(vi) the proposed transfer is not in connection with any security, bond or certificates of participation financing as determined by Agency in its sole discretion; and

(vii) Tenant deposits sufficient funds to reimburse Agency for its reasonable legal expenses to review the proposed assignment.

(c) Delivery of Executed Assignment. No assignment of any interest in this Lease made with Agency's consent, or as herein otherwise permitted, will be effective unless and until there has been delivered to Agency, within thirty (30) days after Tenant entered into such assignment, an executed counterpart of such assignment containing an agreement, in recordable form, executed by Tenant and the transferee, wherein and whereby such transferee assumes performance of all of the obligations on the assignor's part to be performed under this Lease and the other assigned documents to and including the end of the Term unless released (provided, however, that the failure of any transferee to assume this Lease, or to assume one or more of Tenant's obligations under this Lease, will not relieve such transferee from such obligations or

limit Agency's rights or remedies under this Lease or under applicable Law). The form of such instrument of assignment shall be subject to Agency's approval, which approval may be withheld or delayed in Agency's sole and absolute discretion.

(d) No Release of Tenant's Liability or Waiver by Virtue of Consent. The consent by Agency to an assignment hereunder is not in any way to be construed to (i) from and after the date of such assignment, relieve Tenant of any liability arising out of or with regard to the performance of any covenants or obligations to be performed by Tenant hereunder before the date of such assignment, or (ii) relieve any transferee of Tenant from its obligation to obtain the express consent in writing of Agency to any further assignment or to any Significant Change.

(e) Notice of Significant Changes; Reports to Agency. Tenant must promptly notify Agency of any and all Significant Changes. At such time or times as Agency may reasonably request, Tenant must furnish Agency with a statement, certified as true and correct by an officer of Tenant, setting forth all of the constituent members of Tenant and the extent of their respective holdings, and in the event any other Persons have a beneficial interest in Tenant, their names and the extent of such interest.

(f) Determination of Whether Consent is Required. At any time Tenant may submit a request to Agency for the approval of the terms of an assignment, transfer, sublease or encumbrance of this Lease or of a Significant Change (all of the foregoing being collectively referred to herein as a "proposed transfer") or for a decision by Agency as to whether in its opinion a proposed transfer requires Agency consent under the provisions of this Article 15. Within thirty (30) days of the making of such a request and the furnishing by Tenant to Agency of all documents and instruments with respect thereto as shall be requested by Agency, Agency must notify Tenant in writing of Agency's approval or disapproval of the proposed transfer or of Agency's determination that the proposed transfer does not require Agency's consent. If Agency disapproves the proposed transfer, or determines that it requires the consent of Agency, as applicable, it must specify in writing the grounds for its disapproval, its reason that consent is required, or both, as applicable.

(g) Scope of Prohibitions on Assignment. The prohibitions provided in this Section 16.1 will not be deemed to prevent the granting of Subleases so long as such subletting is done in accordance with Section 16.3.

15.2 Assignment of Rents.

Tenant hereby assigns to Agency all rents and other payments of any kind, due or to become due from any or present or future Subtenant as security for Tenant's obligations hereunder prior to actual receipt thereof by Tenant.

15.3 Subletting by Tenant.

(a) Subject to this Section 15.3, the conditions and provisions of which are hereby agreed to be reasonable as of the date hereof, Tenant may sublet any portion of the Premises (the "Subleased Premises") within the Permitted Subleasing Area for a term of not to exceed one (1) year in the aggregate and by a written Sublease in a form reasonably acceptable to the Agency without the necessity of obtaining the prior consent of Agency, to such Persons

and upon such terms and conditions which are consistent with the provisions of this Lease as Tenant may deem to be fit and proper.

(b) Notwithstanding the foregoing,

(i) Tenant shall not (without first obtaining the prior written consent of Agency's Executive Director which may be withheld or delayed in the Executive Director's sole and absolute discretion) sublet any portion of the Permitted Subleasing Area that would, in (A) exceed a term of one (1) year, (B) increase materially the cost of providing City services to the Project Area, or (C) exceed the Term of this Lease.

(ii) The prior written consent of the Agency Commission (which may be withheld or delayed in its sole and absolute discretion) shall also be required as a condition to Agency's approval of Tenant's Sublease of any portion of the Premises that would (A) exceed a term of five (5) years, or (B) include any portion of the Premises located outside the Permitted Subleasing Area.

(c) Notwithstanding the foregoing, Subtenants need not be obligated for Restoration so long as Tenant, or its permitted successors and assigns hereunder, in its capacity as the landlord under each such Sublease, has the right, subject only to reasonable limitations, to terminate the Sublease if the Subtenant does not Restore or, if Tenant has the obligation to Restore the Subtenant Space, Tenant elects not to Restore, and, provided further that Space Subtenants need not be obligated for any obligations not related to the Subleased Spaces, or to undertake any obligations with respect to the Subleased Space that is Tenant's obligation under such Sublease. In no event may the term of any such Sublease extend beyond the Term of this Lease without the prior written consent of Agency, provided, further, that upon expiration of the Term, any such Sublease shall become a direct lease with Agency. It shall be reasonable for Agency to withhold its consent to such extended Subleases if Agency determines, in its reasonable discretion, that it will need the applicable sublease space to accommodate the occupancy of the Agency or other City agency, or in furtherance of an Agency planning effort for the Premises to be implemented at the expiration of the Term hereof. All Subleases shall include terms and conditions consistent in all respects with the provisions of this Lease.

(d) The indemnification provided in this Section is in addition to those indemnification obligations of Tenant set forth in Article 12 hereof, and arise due to Tenant's failure to have entered into Subleases with the tenants of Buildings 101, 110, 808 and 916, as contemplated by the Parties.

As of the Commencement Date of this Lease, the Navy shall have terminated all of its leases on the Premises. As of the Commencement Date of this Lease, Tenant shall assume all the responsibilities of Agency as the owner and landlord of Buildings 101, 110, 808 and 916. Such buildings, together with the land, appurtenant easements and all other real property comprising the premises leased by the occupants thereof pursuant to a lease with the Navy or the Agency, or used by the occupants thereof as if included in the applicable lease with the Navy or the Agency, shall hereinafter be referred to as the "Buildings." Additionally, Tenant shall indemnify Agency and the other Indemnified Parties as to all Losses that arise on or after the Commencement Date

of this Lease with respect to all activities performed, omitted or that occur in connection with the Buildings, the tenants and occupants of the Buildings, together with the employees, contractors, agents, guests and invitees of the tenants or occupants of the Buildings, including, without limitation, the occupation, use, and vacating of such Buildings and any other Losses of any kind arising from Tenant's failure to have executed Subleases with the tenants of Buildings 101, 110, 808 and 916 as of the Commencement Date. Tenant's foregoing indemnity shall include the payment by Tenant of all costs and expenses (as determined by Agency in its sole discretion) incurred by Agency or that arise in connection with relocating any occupant(s) of such Buildings, including without limitation all relocation claims made by occupants who have not waived their relocation rights. Agency's costs will include any associated staff costs whether or not included in the budgeted costs for Phase I. Though Tenant shall endeavor in good faith to enter into Subleases with the current tenants of Buildings 808 and 916, Tenant has no obligation to enter into any Sublease with the current tenants of Buildings 808 and 916, nor is Tenant obligated to ensure the continuing occupancy of Building 808 or Building 916.

15.4 Artists' Subleases.

Tenant shall not cause any Artists to be relocated from buildings 101 and 110, or from any other Premises on the Shipyard, that are lawfully occupied by Artists pursuant to leases or subleases as of the date of this Agreement (except as set forth in Section 13.4 above) or cause the Artists' rent for such space to increase. On or before the conveyance by the Navy of the Premises to Agency, the Navy shall terminate all of its leases on the Premises, and Tenant shall (to the extent not otherwise prohibited by law) enter into new Subleases with those artists who were tenants under the leases terminated by the Navy (each an "Artist" and more than one such Artist, collectively, the "Artists"). The new Subleases for the Artists in Buildings 101 and 110, located on Parcel A of the Shipyard, or in any other Premises on the Shipyard that are lawfully occupied by Artists pursuant to leases or subleases as of the date of this Agreement, shall contain the same economic terms and conditions as existed under the corresponding leases or Subleases with or through the Navy. Pursuant to the terms of Subleases entered into prior to Tenant's commencement of construction on Parcel B that requires the relocation of Artists from Buildings 103 or 104, Tenant will provide space in Parcel A for the Artists in Buildings 103 and 104, located on Parcel B of the Shipyard. Notwithstanding the foregoing provisions of this Section 15.4, all Subleases shall contain provisions that require all Subtenants, including, without limitation, Artists, to waive any and all relocation rights.

15.5 Non-Disturbance of Subtenants, Attornment, Sublease Provisions.

(a) Conditions for Non-Disturbance Agreements. From time to time upon the request of Tenant, Agency shall enter into agreements with Subtenants providing generally, with regard to a given Sublease, that in the event of any termination of this Lease, Agency will not terminate or otherwise disturb the rights of the Subtenant under such Sublease, but will instead honor such Sublease as if such agreement had been entered into directly between Agency and such Subtenant ("Non-Disturbance Agreements"). All Non-Disturbance Agreements shall comply with the provisions of this Section 15.5(a) and of Section 15.5(b). Agency shall provide a Non-Disturbance Agreement to a Subtenant if all of the following conditions are satisfied: (i) the performance by Tenant of its obligations under such Sublease will not cause an Event of Default to occur under this Lease; (ii) the term of the Sublease, including options, does not

) extend beyond the scheduled Term, unless Agency approves such longer term with the agreement that in such event, such subleases shall become direct lease with the Agency upon the expiration of the Term hereof; (iii) the Sublease contains provisions whereby the Subtenant agrees to comply with applicable provisions of Section 26.1(a) and 26.2; (iv) the Subtenant agrees that in the event this Lease expires, terminates or is canceled during the term of the Sublease, the Subtenant shall attorn to Agency (provided Agency agrees not to disturb the occupancy or other rights of the Subtenant and to be bound by the terms of the Sublease), and the Sublease shall be deemed a direct lease or license agreement between the Subtenant and Agency, except that Agency shall not be liable to the Subtenant for any security deposit or prepaid rent or license fees previously paid by such Subtenant to Tenant unless such deposits are transferred to Agency, except for rent or license fees for the current month, if previously paid; (v) if Tenant is then in default of any of its obligations under this Lease, Agency may condition its agreement to provide a Non-Disturbance Agreement on the cure of such defaults as Agency may specify either in a notice of default given under Section 17.1 or in a notice conditionally approving Tenant's request for such Non-Disturbance Agreement (and if an Event of Default on the part of Tenant then exists, then Agency may withhold or condition the giving of a Non-Disturbance Agreement), and (vi) the Subtenant shall have delivered to Agency an executed estoppel certificate, in a form reasonably acceptable to Agency, certifying: (A) that the Sublease, including all amendments, is attached thereto and is unmodified, except for such attached amendments, and is in full force and effect, as so amended, or if such Sublease is not in full force and effect, so stating, (B) the dates, if any, to which any rent and other sums payable thereunder have been paid, and (C) that the Subtenant is not aware of any defaults which have not been cured, except as to defaults specified in said certificate. In addition, with respect to Subleases of more than ten thousand (10,000) square feet or having a term of more than ten (10) years (including options to extend the term), or any Subleases with an Affiliate of Tenant regardless of the size of the Subleased Premises or the length of the term, Agency may condition its consent on its reasonable approval of the form and material business terms of the Sublease in light of market conditions existing at the time such Sublease is entered into. Notwithstanding the foregoing sentence, if any such Sublease or an option to extend included therein, includes an adjustment of rent based on a fair rental value reappraisal, Agency shall not withhold its consent to entering into a Non-Disturbance Agreement based on the rental terms of the Sublease. Agency shall not be required to enter into a Non-Disturbance Agreement with respect to any period beyond the scheduled expiration of the Term hereof. Agency shall respond to any request for a Non-Disturbance Agreement within thirty (30) days after receipt of a true and complete copy of the relevant Sublease in the form to be executed, and all relevant information requested by Agency. Such relevant information shall include reasonable financial information establishing the ability of the proposed Subtenant to perform its contemplated obligations under such Sublease, and relevant information concerning the business character and reputation of the proposed Subtenant. Agency agrees to cooperate, to the extent it is legally permitted to do so, in protecting the confidentiality of personal or financial information relating to any Subtenant. Nothing in this Section 15.5 shall preclude Agency in its sole and absolute discretion from granting non-disturbance to other Subtenants.

) (b) Form of Non-Disturbance Agreement. Each Non-Disturbance Agreement shall be in a form and substance agreed upon by Tenant and Agency, not to be unreasonably withheld by either Party. With each request for a Non-Disturbance Agreement, Tenant shall submit a copy of the form, showing any requested interlineations or deletions, and Agency shall

) approve or disapprove of the requested changes within twenty (20) days after receipt of such changes (such approval not to be unreasonably withheld or conditioned). Any disapproval by Agency shall be in writing, and shall set forth the specific reasons for Agency's disapproval. Failure by Agency to approve or disapprove of specific interlineations, deletions or other modifications requested by a Subtenant within such twenty (20) day period shall be deemed to be approval of the requested changes (subject to Section 27.1).

ARTICLE 16. AGENCY'S RIGHT TO PERFORM TENANT'S COVENANTS.

16.1 Agency May Perform in Emergency.

) Without limiting any other provision of this Lease, and in addition to any other rights or remedies available to Agency for any default on the part of Tenant under this Lease, if Tenant fails to perform any maintenance or repairs required to be performed by Tenant hereunder within the time provided for such performance, which failure gives rise to an emergency which creates an imminent danger to public health or safety, as reasonably determined by Agency, Agency may at its sole option, but shall not be obligated to, perform such obligation for and on behalf of Tenant, provided that, if there is time, Agency first gives Tenant such notice and opportunity to take corrective action as is reasonable under the circumstances. Nothing in this Section shall be deemed to limit Agency's ability to act in its legislative or regulatory capacity, including the exercise of its police powers, nor to waive any claim on the part of Tenant that any such action on the part of Agency constitutes a Condemnation or an impairment of Tenant's contract with Agency.

16.2 Agency May Perform Following Tenant's Failure to Perform.

) Without limiting any other provision of this Lease, and in addition to any other rights or remedies available to Agency for any default on the part of Tenant under this Lease, if at any time Tenant fails to pay any sum required to be paid by Tenant pursuant to this Lease to any Person other than Agency (other than any Imposition, with respect to which the provisions of Section 8.3 shall apply), or if Tenant fails to perform any obligation on Tenant's part to be performed under this Lease, which failure continues without cure following written notice from Agency for a period of thirty (30) days (or, if Section 11.1(c) is applicable, which failure continues for five (5) business days after written notice from Agency), and is not the subject of a contest under Section 8.3, then, Agency may, upon such five (5) business days prior written notice to Tenant, at its sole option, but shall not be obligated to, pay such sum or perform such obligation for and on behalf of Tenant. Notwithstanding the foregoing, however, if within such period Tenant gives notice to Agency that such failure is due to delay caused by Force Majeure, or is the subject of a contest under Section 8.3, or that cure of such failure cannot reasonably be completed within such period, then Agency will not pay such sum or perform such obligation during the continuation of such contest or such Force Majeure delay or extended cure period, as the case may be, for so long thereafter as Tenant continues diligently to prosecute such contest or cure or the resolution of such event of Force Majeure.

16.3 Tenant's Obligation to Reimburse Agency.

If pursuant to the provisions of Sections 11.1(c), 16.1, or 16.2, Agency pays any sum or performs any obligation required to be paid or performed by Tenant hereunder, Tenant shall reimburse Agency within thirty (30) business days following demand, as Additional Rent, the sum so paid, or the reasonable expense incurred by Agency in performing such obligation, together with interest thereon at the Default Rate, if such payment is not made within such period, computed from the date of Agency's demand until payment is made. Agency's rights under this Article 16 shall be in addition to its rights under any other provision of this Lease (including, but not limited to, access to the security deposit required under Section 3.8 of this Lease) or under applicable laws.

ARTICLE 17. EVENTS OF DEFAULT; TERMINATION.

17.1 Events of Default.

The occurrence of any one or more of the following events which remain uncured after the passage of time as set forth pursuant to this Article 17 shall constitute an "Event of Default" under the terms of this Lease:

(a) Tenant fails to pay any Rent to Agency when due, which failure continues for ten (10) days following written notice from Agency (it being understood and agreed that the notice required to be given by Agency under this Section 17.1(a) shall also constitute the notice required under Section 1161 of the California Code of Civil Procedures or its successor, and shall satisfy the requirements that notice be given pursuant to such section); provided, however, Agency shall not be required to give such notice on more than three occasions during any calendar year, and failure to pay any Rent thereafter when due shall be an immediate Event of Default without need for further notice;

(b) Tenant fails, subject to the provisions of Section 27.22, or refuses to provide any of the Required Services;

(c) An Event of Default (as defined in the ENA or DDA) on the part of Tenant, as Tenant, occurs under the ENA and/or DDA (so long as it is in effect) but such Event of Default under this Agreement shall be deemed cured if the Event of Default as defined in the ENA and/or DDA is cured pursuant thereto;

(d) Tenant files a petition for relief, or an order for relief is entered against Tenant, in any case under applicable bankruptcy or insolvency Law, or any comparable Law that is now or hereafter may be in effect, whether for liquidation or reorganization, which proceedings if filed against Tenant are not dismissed or stayed within one hundred twenty (120) days;

(e) A writ of execution is levied on the Leasehold Estate which is not released within one hundred twenty (120) days, or a receiver, trustee or custodian is appointed to take custody of all or any material part of the property of Tenant, which appointment is not dismissed within one hundred twenty (120) days;

(f) Tenant makes a general assignment for the benefit of its creditors;

(g) Tenant abandons the Premises, within the meaning of California Civil Code Section 1951.2 (or its successor), which abandonment is not cured within fifteen (15) days after notice of belief of abandonment from Agency;

(h) Tenant fails to maintain any insurance required to be maintained by Tenant under this Lease, which failure continues without cure for five (5) business days after written notice from Agency, or, if such cure cannot be reasonably completed within such five (5) business day period, if Tenant does not within such five (5) business day period commence such cure, or having so commenced, does not prosecute such cure with diligence and dispatch to completion within a reasonable time thereafter;

(i) Tenant violates any other covenant, or fails to perform any other obligation to be performed by Tenant under this Lease (including, but not limited to, any Mitigation Measures to the extent applicable to the activities performed under this Lease) at the time such performance is due, and such violation or failure continues without cure for more than thirty (30) days after written notice from Agency specifying the nature of such violation or failure, or, if such cure cannot reasonably be completed within such thirty (30)-day period, if Tenant does not within such thirty (30)-day period commence such cure, or having so commenced, does not prosecute such cure with diligence and dispatch to completion within a reasonable time thereafter; or

(j) Tenant suffers or permits an assignment of this Lease or any interest therein to occur in violation of this Lease or suffers or permits a Significant Change to occur in violation of this Lease, which Event of Default is not cured within thirty (30) days by an effective rescission of the assignment or Significant Change or through Agency's consent, which may be given or withheld in Agency's sole and absolute discretion; provided, however, that if the assignment, sublease or Significant Change is the result of a willful and knowing action on the part of Tenant to make an assignment, sublease or Significant Change in violation of Section 15.1, the thirty (30) day cure period will not apply.

ARTICLE 18. REMEDIES.

18.1 Agency's Remedies Generally.

Upon the occurrence and during the continuance of an Event of Default under this Lease (but without obligation on the part of Agency following the occurrence of an Event of Default to accept a cure of such Event of Default other than as required by Law or the terms of this Lease), Agency shall have all rights and remedies provided in this Lease or available at law or equity; provided, however, notwithstanding anything to the contrary in this Lease, the remedies of Agency for any Event of Default by Tenant under the Equal Opportunity Program, the Prevailing Wage Provisions, or the First Source Hiring program shall be limited to the remedies provided in such exhibits. All of Agency's rights and remedies shall be cumulative, and except as may be otherwise provided by applicable Law, the exercise of any one or more rights shall not preclude the exercise of any others.

18.2 Right to Terminate Lease.

(a) Damages. Agency may terminate this Lease at any time after the occurrence (and during the continuation) of an Event of a Default by giving written notice of such termination. Termination of this Lease shall thereafter occur on the date set forth in such notice. Acts of maintenance or preservation, and any appointment of a receiver upon Agency's initiative to protect its interest hereunder shall not in any such instance constitute a termination of Tenant's right to possession. No act by Agency other than giving notice of termination to Tenant in writing shall terminate this Lease. On termination of this Lease, Agency shall have the right to recover from Tenant all sums allowed under California Civil Code Section 1951.2, including, without limitation, the following:

(i) The worth at the time of the award of the unpaid Rent which had been earned at the time of termination of this Lease;

(ii) The worth at the time of the award of the amount by which the unpaid Rent which would have been earned after the date of termination of this Lease until the time of the award exceeds the amount of the loss of Rent that Tenant proves could have been reasonably avoided;

(iii) The worth at the time of the award of the amount by which the unpaid Rent for the balance of the Term after the time of award exceeds the amount of the loss of Rent that Tenant proves could have been reasonably avoided;

(iv) Any other amount necessary to compensate Agency for all detriment proximately caused by the default of Tenant, or which in the ordinary course of things would be likely to result therefrom; and

(v) "The worth at the time of the award", as used in Section 18.3(a)(i) and (ii) shall be computed by allowing interest at a rate per annum equal to the Default Rate. "The worth at the time of the award", as used in Section 18.3(a)(iii), shall be computed by discounting such amount at the discount rate of the Federal Reserve Bank of San Francisco at the time of the award, plus one percent (1%).

(b) Interest. Rent not paid when due shall bear interest from the date due until paid at the Default Rate.

(c) Waiver of Rights to Recover Possession. In the event Agency terminates Tenant's right to possession of the Premises pursuant to this Section 18.3, Tenant hereby waives any rights to recover or regain possession of the Premises under any rights of redemption to which it may be entitled by or under any present or future Law, including, without limitation, California Code of Civil Procedure Sections 1174 and 1179 or any successor provisions.

(d) No Rights to Assign. Upon the occurrence of an Event of Default, notwithstanding Article 15 Tenant shall have no right to assign its interest in the Premises or this Lease without Agency's written consent, which may be given or withheld in Agency's sole and absolute discretion.

18.3 Continuation of Subleases and Other Agreements.

Subject to the terms of any Non-Disturbance Agreements entered into by Agency in accordance with Section 15.5 hereof, Agency shall have the right, at its sole option, to assume any and all Subleases and agreements by Tenant for the maintenance or operation of the Premises. Tenant hereby further covenants that, upon request of Agency following an Event of Default and termination of Tenant's interest in this Lease, Tenant shall execute, acknowledge and deliver to Agency such further instruments as may be necessary or desirable to vest or confirm or ratify vesting in Agency the then existing Subleases and other agreements then in force, as above specified.

18.4 Agency's Equitable Relief.

In addition to the other remedies provided in this Lease, Agency shall be entitled at any time after a default or threatened default by Tenant to seek injunctive relief or an order for specific performance, where appropriate to the circumstances of such default. In addition, after the occurrence of an Event of Default, Agency shall be entitled to any other equitable relief which may be appropriate to the circumstances of such Event of Default.

18.5 Nonliability of Tenant's Members, Partners, Shareholders, Directors, Officers and Employees.

Except with respect to any obligations under the Interim Lease Guarantee, no member, officer, partner, shareholder, director, agent, or employee of Tenant will be personally liable to the Agency, in an Event of Default by Tenant or for any amount which may become due to the Agency or on any obligations under the terms of this Lease, and Agency agrees that except with respect to Agency's rights under the Interim Lease Guarantee, it will have no recourse with respect to any obligation of Tenant under this Lease, or for any amount which may become due to Agency or any successor or for any obligation or claim based upon this Lease, against such Person.

ARTICLE 19. DEFAULT BY AGENCY; TENANT'S REMEDIES.

19.1 Default by Agency; Tenant's Exclusive Remedies.

Agency shall be deemed to be in default hereunder only if Agency shall fail to perform or comply with any obligation on its part hereunder and (i) such failure shall continue for more than the time of any cure period provided herein, or, (ii) if no cure period is provided herein, for more than sixty (60) days after written notice thereof from Tenant (provided, that, Agency shall use reasonable efforts to cure such default within a thirty (30) day period), or, (iii) if such default cannot reasonably be cured within such sixty (60)-day period, Agency shall not within such period commence with due diligence and dispatch the curing of such default, or, having so commenced, shall thereafter fail or neglect to prosecute or complete with diligence and dispatch the curing of such default. Upon the occurrence of default by Agency described above, which default substantially and materially interferes with the ability of Tenant to conduct the use on the Premises provided for hereunder, Tenant shall have the exclusive right (a) to offset or deduct only from the Rent becoming due hereunder, the amount of all actual damages incurred by

Tenant as a direct result of Agency's default, pursuant to a final, unappealable judgment in a court of competent jurisdiction for such damages in accordance with applicable Law and the provisions of this Lease, or (b) to seek equitable relief in accordance with applicable Laws and the provisions of this Lease where appropriate and where such relief does not impose personal liability on Agency or its Agents; provided, however, (i) in no event shall Tenant be entitled to offset from all or any portion of the Rent becoming due hereunder or to otherwise recover or obtain from Agency or its Agents any damages (including, without limitation, any consequential, incidental, punitive or other damages proximately arising out of a default by Agency hereunder) or Losses other than Tenant's actual damages as described in the foregoing clause (a); (ii) Tenant agrees that, notwithstanding anything to the contrary herein or pursuant to any applicable Laws, Tenant's remedies hereunder shall constitute Tenant's sole and absolute right and remedy for a default by Agency hereunder, and (iii) Tenant shall have no remedy of self-help.

19.2 No Recourse Beyond Value of Premises Except as Specified.

Tenant agrees that except as otherwise specified in this Section 19.2, Tenant will have no recourse with respect to, and Agency shall not be liable for, any obligation of Agency under this Lease, or for any claim based upon this Lease, except to the extent of the fair market value of Agency's fee interest in the Premises (as encumbered by this Lease). By Tenant's execution and delivery hereof and as part of the consideration for Agency's obligations hereunder Tenant expressly waives all such liability.

19.3 No Recourse Against Specified Persons.

No commissioner, officer or employee of Agency or City will be personally liable to Tenant, or any successor in interest, for any Event of Default by Agency, and Tenant agrees that it will have no recourse with respect to any obligation of Agency under this Lease, or for any amount which may become due Tenant or any successor or for any obligation or claim based upon this Lease, against any such Person.

19.4 Tenant's Equitable Relief.

In addition to the other remedies provided in this Lease, Tenant shall be entitled at any time after a default or threatened default by Agency to seek injunctive relief or an order for specific performance, where appropriate to the circumstances of such default. In addition, after the occurrence of an Event of Default, Tenant shall be entitled to any other equitable relief which may be appropriate to the circumstances of such Event of Default.

19.5 Arbitration of Certain Matters.

If (a) Agency disapproves, or conditionally approves, any item of Construction, which disapproval, or conditional approval Tenant, acting in good faith, deems to be unreasonable, or (b) if Agency disapproves Tenant's request to discontinue earthquake or flood insurance based upon commercial unreasonableness in accordance with Section 11.1(a)(ii) hereof, Tenant may submit the matter to arbitration in accordance with the dispute resolution provisions set forth herein. Within twenty (20) business days after delivery of notice invoking the provisions of this Section, each Party shall designate, by written notice to the other Party, a person having at least ten (10) years experience in managing and developing commercial real estate projects in San

) Francisco, including comparable mixed use retail/office projects. Each such person shall be competent, licensed, qualified by training and experience in the City, disinterested and independent. Within ten (10) days of their appointment, the persons selected by each Party shall choose a third person meeting the foregoing qualifications, or if they cannot agree within such time then either Party, on behalf of both, may request that appointment of an arbitrator be designated by JAMS/Endispute in San Francisco, California, and the other Party shall not raise any questions as to such person's full power and jurisdiction to entertain the application for and make the appointment. If either Party fails to appoint such person within such twenty (20) day period, the person appointed by the other Party shall be the Arbiter for purposes hereof. For purposes of this section, the arbiter appointed by the two persons selected by the Parties (or, if the other Party fails to appoint such person, then the person appointed by the other Party) shall be referred to as the "Arbiter".

(i) Each Party initially shall advance 50% of the required arbitration fee. Within fifteen (15) days following written notice to the Arbiter or the appointment of the arbitrator (as the case may be), each Party shall state in writing the reasons it believes that the Agency's failure to approve the Construction Item or request to discontinue earthquake/flood insurance, as applicable, to be unreasonable, and attach such supporting statements and materials as it shall deem appropriate, and deliver such statement with attachments to the Arbiter and to the other Party. If a Party does not so deliver such statement or if a Party fails to appear at the hearing, the Arbiter may enter a default award against such Party, provided said Party received actual notice of the hearing. In order to obtain a default award, the complaining Party need not first seek or obtain an order to arbitrate the controversy pursuant to Code of Civil Procedure § 1281.2.

(ii) The Arbiter shall issue its opinion within ten (10) business days after his or her receipt of the statements. The unsuccessful Party shall pay the legal fees of the prevailing Party. If the Arbiter refuses to or fails to act within such time, JAMS/Endispute shall appoint a successor arbitrator. The Arbiter's review and decision shall be limited to whether or not the Agency acted reasonably in disapproving, or conditionally approving, the Construction Item, or if the discontinuance of earthquake/flood insurance is commercially unreasonable, as applicable. Except as otherwise provided, the Arbiter shall have no power to add to, subtract from, disregard, modify or otherwise alter the terms of the this Agreement, or any other agreement between the Agency and Tenant, or to negotiate new agreements or provisions between the Parties. A decision of the Arbiter issued hereunder shall be final and binding upon the Agency and Tenant, unless a Party files a request for judicial relief with a court of competent jurisdiction with respect to the decision within fifteen (15) working days after the issuance of the Arbiter's decision. If any such claim is timely filed, the petitioning Party shall be entitled to de novo judicial review.

(iii) The losing Party in arbitration shall pay the arbitrator's fees and related costs of arbitration. Each Party shall pay its own attorneys' fees provided that fees may be awarded to the prevailing Party if the arbitrator finds that the request was frivolous or that the arbitration action was otherwise instituted or litigated in bad faith. Judgment upon the Arbiter's decision may be entered in any court of competent jurisdiction.

(iv) California Law, including the California Arbitration Act, Code of Civil Procedure §§ 1280 through 1294.2 shall govern all arbitration proceedings.

ARTICLE 20. LIMITATIONS ON LIABILITY; ESTOPPEL CERTIFICATE.

20.1 Waiver of Consequential Damages.

As a material part of the consideration for this Lease, neither Party shall be liable for, and each Party hereby waives any claims against the other for any consequential damages arising out of any such party's default.

20.2 Limitation on Parties' Liability Upon Transfer.

In the event of any transfer of Agency's or Tenant's interest in and to the Premises, Agency or Tenant, as the case may be, subject to the provisions hereof, (and in case of any subsequent transfers, the then transferor) will automatically be relieved from and after the date of such transfer of all liability with regard to the performance of any covenants or obligations contained in this Lease thereafter to be performed on the part of Agency or Tenant, as the case may be (or such transferor, as the case may be), but not from liability incurred by Agency or Tenant, as the case may be (or such transferor, as the case may be) on account of covenants or obligations to be performed by Agency or Tenant, as the case may be (or such transferor, as the case may be) hereunder before the date of such transfer; provided, however, that Agency or Tenant, as the case may be (or such subsequent transferor) has transferred to the transferee any funds in Agency's or Tenant's possession (or in the possession of such subsequent transferor) in which Agency or Tenant (or such subsequent transferor) has an interest, in trust, for application pursuant to the provisions hereof, and such transferee has assumed all liability for all such funds so received by such transferee from Agency or Tenant as the case may be (or such subsequent transferor).

20.3 Estoppel Certificate by Tenant.

Tenant shall execute, acknowledge and deliver to Agency (or at Agency's request, to a prospective purchaser or mortgagee of Agency's interest in the Premises), within fifteen (15) business days after a request, a certificate stating to the best of Tenant's knowledge after diligent inquiry (a) that this Lease is unmodified and in full force and effect (or, if there have been modifications, that this Lease is in full force and effect, as modified, and stating the modifications or, if this Lease is not in full force and effect, so stating), (b) the dates, if any, to which any Rent and other sums payable hereunder have been paid, (c) that no notice has been received by Tenant of any default hereunder which has not been cured, except as to defaults specified in such certificate and (d) any other matter actually known to Tenant, directly related to this Lease and reasonably requested by Agency. In addition, if requested, Tenant shall attach to such certificate a copy of this Lease, and any amendments thereto, and include in such certificate a statement by Tenant that, to the best of its knowledge, such attachment is a true, correct and complete copy of this Lease, as applicable, including all modifications thereto. Any such certificate may be relied upon by any Agency, any successor agency, and any prospective purchaser or mortgagee of the Premises or any part of Agency's interest therein. Tenant will also use commercially reasonable efforts (including inserting a provision similar to this Section into

each Sublease) to cause Subtenants under Subleases to execute, acknowledge and deliver to Agency, within twenty (20) business days after request, an estoppel certificate covering the matters described in clauses (a), (b), (c) and (d) above with respect to such Sublease, but Tenant shall not be in default hereunder for failure of such Subtenants to comply with such provisions, nor shall Tenant be obligated to take any action against such Subtenants for failure to so comply.

ARTICLE 21. NO WAIVER.

21.1 No Waiver by Agency or Tenant.

No failure by Agency or Tenant to insist upon the strict performance of any term of this Lease or to exercise any right, power or remedy consequent upon a breach of any such term, shall be deemed to imply any waiver of any such breach or of any such term unless clearly expressed in writing by the Party against which waiver is being asserted. No waiver of any breach shall affect or alter this Lease, which shall continue in full force and effect, or the respective rights of Agency or Tenant with respect to any other then existing or subsequent breach.

21.2 No Accord or Satisfaction.

No submission by Tenant or acceptance by Agency of full or partial Rent or other sums during the continuance of any failure by Tenant to perform its obligations hereunder shall waive any of Agency's rights or remedies hereunder or constitute an accord or satisfaction, whether or not Agency had knowledge of any such failure, except with respect to the Rent so paid. No endorsement or statement on any check or remittance by or for Tenant or in any communication accompanying or relating to such payment shall operate as a compromise or accord or satisfaction unless the same is approved as such in writing by Agency. Agency may accept such check, remittance or payment and retain the proceeds thereof, without prejudice to its rights to recover the balance of any Rent, including any and all Additional Rent, due from Tenant and to pursue any right or remedy provided for or permitted under this Lease or in law or at equity. No payment by Tenant of any amount claimed by Agency to be due as Rent hereunder (including any amount claimed to be due as Additional Rent) shall be deemed to waive any claim which Tenant may be entitled to assert with regard to the making of such payment or the amount thereof, and all such payments shall be without prejudice to any rights Tenant may have with respect thereto, whether or not such payment is identified as having been made "under protest" (or words of similar import).

ARTICLE 22. SURRENDER OF PREMISES; HOLDOVER.

22.1 End of Lease Term.

(a) Conditions of Premises. Upon the expiration or other termination of the Term of this Lease, Tenant shall quit and surrender to Agency the Premises in good order and condition, reasonable wear and tear excepted to the extent the same is consistent with maintenance of the Premises in the condition required. The Premises shall be surrendered with all Improvements, repairs, alterations, additions, substitutions and replacements thereto subject to

Section 22.2. Tenant hereby agrees to execute all documents as Agency may deem necessary to evidence or confirm any such other termination.

(b) Subleases. Upon any termination of this Lease, Agency shall have the right to terminate all Subleases hereunder except for those Subleases with respect to which Agency has entered into Non-Disturbance Agreements as provided in Section 15.5, or which Agency has agreed to assume pursuant to Section 15.3 or Section 18.3.

(c) Personal Property. Upon expiration or termination of this Lease, Tenant and all Subtenants shall have the right to remove their respective trade fixtures and other personal property. At Agency's request, Tenant shall remove, at no cost to Agency, any Personal Property belonging to Tenant which then remains on the Premises (excluding any personal property owned by Subtenants or other Persons). If the removal of such Personal Property causes damage to the Premises, Tenant shall repair such damage, at no cost to Agency.

22.2 Hold Over.

Any holding over by Tenant after the expiration or termination of this Lease shall not constitute a renewal hereof or give Tenant any rights hereunder or in the Premises, except with the written consent of Agency. In any such event, at Agency's option, Tenant shall be (a) a tenant at sufferance, or (b) a month-to-month tenant at the Minimum Rent in effect at the expiration of the Term Indexed from the date of hold-over.

ARTICLE 23. NOTICES.

23.1 Notices. All notices, demands, consents, and requests which may or are to be given by any Party to the other shall be in writing, except as otherwise provided herein. All notices, demands, consents and requests to be provided hereunder shall be deemed to have been properly given on the date of receipt if served personally on a day that is a business day (or on the next business day if served personally on a day that is not a business day), or, if mailed, on the date that is three days after the date when deposited with the U.S. Postal Service for delivery by United States registered or certified mail, postage prepaid, in either case, addressed as follows:

To Agency: San Francisco Redevelopment Agency
770 Golden Gate Avenue
San Francisco, CA 94102
Attention: Executive Director
Facsimile: (415) 749-2525

with a copy to: Legal Department
San Francisco Redevelopment Agency
(Reference: Lennar/BVHP)
770 Golden Gate Avenue
San Francisco, CA 94102
Facsimile: (415) 749-2575

To Tenant: Lennar BVHP Partners
c/o Lennar
49 Stevenson Street, #525
San Francisco CA 94105
Facsimile: (415) 995-1778

with a copy to: Sheppard, Mullin, Richter & Hampton LLP
Four Embarcadero Center, 17th Floor
San Francisco, CA 94111
Attn: Robert A. Thompson
Facsimile: (415) 434-3947

or at such other place or places in the United States as each such Party may from time to time designate by written notice to the other in accordance with the provisions hereof. For convenience of the Parties, copies of notices may also be given by telefacsimile to the facsimile number set forth above or such other number as may be provided from time to time by notice given in the manner required hereunder; however, neither Party may give official or binding notice by telefacsimile.

23.2 Form and Effect of Notice.

Every notice given to a Party or other Person under this Section must state (or shall be accompanied by a cover letter that states):

- (a) the Section of this Lease pursuant to which the notice is given and the action or response required, if any;
- (b) if applicable, the period of time within which the recipient of the notice must respond thereto; and
- (c) if applicable, that the failure to object to the notice within a stated time period will be deemed to be the equivalent of the recipient's approval of or consent to the subject matter of the notice.

In no event shall a recipient's approval of or consent to the subject matter of a notice be deemed to have been given by its failure to object thereto if such notice (or the accompanying cover letter) does not comply with the requirements of this Section 23.2.

ARTICLE 24. INSPECTION OF PREMISES BY AGENCY.

24.1 Entry.

Subject to the rights of Subtenants, Tenant shall permit Agency and its Agents to enter the Premises during Normal business hours upon reasonable prior written notice (and at any time in the event of an emergency which poses an imminent danger to public health or safety) for the purpose of (i) inspecting the same for compliance with any of the provisions of this Lease, (ii) performing any work therein that Agency may have a right to perform under Article 16, or

(iii) inspecting, sampling, testing and monitoring the Premises or the Improvements or any portion thereof, including buildings, grounds and subsurface areas, as Agency reasonably deems necessary or appropriate for evaluation of Hazardous Materials or other environmental conditions. Nothing herein shall imply any duty upon the part of Agency to perform any work which under any provision of this Lease Tenant may be required to perform, nor to place upon Agency any obligation, or liability, for the care, supervision or repair of the Premises; provided, however, Agency agrees to minimize interference with the activities and tenancies of Tenant, Subtenants and their respective Invitees. If Agency elects to perform work on the Premises pursuant to Article 16, Agency shall not be liable for inconvenience, loss of business or other damage to Tenant by reason of the performance of such work on the Premises, or on account of bringing necessary materials, supplies and equipment into or through the Premises during the course thereof, provided Agency uses reasonable diligence to minimize the interference any such work may cause with the activities of Tenant, its Subtenants, and their respective Invitees.

24.2 Exhibit for Lease.

Subject to the rights of Subtenants, Tenant shall permit Agency and its Agents to enter the Premises during Normal business hours upon reasonable prior written notice (i) to exhibit the same in a reasonable manner in connection with any sale, transfer or other conveyance of Agency's interest in the Premises, and (ii) during the last six (6) months of the Term, for the purpose of leasing the Premises.

24.3 Notice, Right to Accompany.

Agency agrees to give Tenant reasonable prior notice of Agency's entering on the Premises except in an emergency for the purposes set forth in Sections 24.1 and 24.2. Such notice shall be not less than forty-eight (48) hours prior notice. Tenant shall have the right to have a representative of Tenant accompany Agency or its Agents on any entry into the Premises. Notwithstanding the foregoing, no notice shall be required for Agency's entry onto public areas of the Premises during normal business hours unless such entry is for the purposes set forth in Sections 24.1 and 24.2.

24.4 Rights of Subtenants.

Tenant agrees to use commercially reasonable efforts (including efforts to obtain the agreement of each Subtenant (other than Agency) to the inclusion of a provision similar to Section 24.1 in its Sublease) to require each Subtenant to permit Agency to enter its premises for the purposes specified in this Article 24. If Tenant is unable to obtain such agreement after commercially reasonable efforts, Tenant shall use commercially reasonable efforts to include a right of entry for Agency upon terms customary for comparable leases in San Francisco.

ARTICLE 25. REPRESENTATIONS AND WARRANTIES.

25.1 Representations and Warranties of Tenant.

Tenant represents, warrants and covenants to Agency as follows, as of the date hereof and as of the Commencement Date:

(a) Valid Existence; Good Standing. Tenant is a limited liability company duly organized and validly existing under the laws of the State of California. Tenant has the requisite power and authority to own its property and conduct its business as presently conducted. Tenant is in good standing in the State of California.

(b) Authority. Tenant has the requisite power and authority to execute and deliver this Lease and the agreements contemplated hereby and to carry out and perform all of the terms and covenants of this Lease and the agreements contemplated hereby to be performed by Tenant.

(c) No Limitation on Ability to Perform. Neither Tenant's articles of organization or operating agreement, nor any applicable Law, prohibits Tenant's entry into this Lease or its performance hereunder. No consent, authorization or approval of, and no notice to or filing with, any governmental authority, regulatory body or other Person is required for the due execution and delivery of this Lease by Tenant and Tenant's performance hereunder, except for consents, authorizations and approvals which have already been obtained, notices which have already been given and filings which have already been made. Except as may otherwise have been disclosed to Agency in writing, there are no undischarged judgments pending against Tenant, and Tenant has not received notice of the filing of any pending suit or proceedings against Tenant before any court, governmental agency, or arbitrator, which might materially adversely affect the enforceability of this Lease or the business, operations, assets or condition of Tenant.

(d) Valid Execution. The execution and delivery of this Lease and the performance by Tenant hereunder have been duly and validly authorized. When executed and delivered by Agency and Tenant, this Lease will be a legal, valid and binding obligation of Tenant.

(e) Defaults. The execution, delivery and performance of this Lease (i) do not and will not violate or result in a violation of, contravene or conflict with, or constitute a default by Tenant under (A) any agreement, document or instrument to which Tenant is a party or by which Tenant is bound, (B) any Law, statute, ordinance, or regulation applicable to Tenant or its business, or (C) the articles of organization or the operating agreement of Tenant, and (ii) do not result in the creation or imposition of any lien or other encumbrance upon the assets of Tenant, except as contemplated hereby.

(f) Financial Matters. Except to the extent disclosed to Agency in writing, (i) Tenant is not in default under, and has not received notice asserting that it is in default under, any agreement for borrowed money, (ii) Tenant has not filed a petition for relief under any chapter of the U.S. Bankruptcy Code, (iii) there has been no event that has materially adversely affected Tenant's ability to meet its Lease obligations hereunder, and (iv) to Tenant's knowledge, no involuntary petition naming Tenant as debtor has been filed under any chapter of the U.S. Bankruptcy Code.

The representations and warranties herein shall survive any termination of this Lease to the extent specified in this Lease.

ARTICLE 26. SPECIAL PROVISIONS.

26.1 Non-Discrimination.

(a) Covenant Not to Discriminate. In the performance of this Lease, Tenant covenants and agrees not to discriminate on the basis of the fact or perception of a person's race, color, creed, religion, national origin, ancestry, age, sex, sexual orientation, gender identity, domestic partner status, marital status, disability or Acquired Immune Deficiency Syndrome or HIV status (AIDS/HIV status) against any employee of, any City employee working with, or applicant for employment with Tenant, in any of Tenant's operations within the United States, or against any person seeking accommodations, advantages, facilities, privileges, services, or membership in all business, social, or other establishments or organizations operated by Tenant.

(b) [intentionally left blank]

26.2 Contract Requirements.

(a) Equal Opportunity Program. It is the policy of the City and County of San Francisco to act to give effect to the rights of every inhabitant of the City and County to equal economic, political and educational Opportunity. Pursuant to the policy, Agency and Tenant agree that it is appropriate to include in this Lease Equal Opportunity Program provisions consistent with those set forth in Exhibit A to Attachment 24 to the DDA (the "Equal Opportunity Program") designed to afford opportunities for minority-owned enterprises, women-owned enterprises, and San Francisco residents, to participate in the operation and use of the Premises.

(b) Nondiscrimination in Benefits. Tenant does not as of the date of this Lease and will not during the Term, in any of its operations in San Francisco or with respect to its operations under this Lease elsewhere within the United States, discriminate in the provision of bereavement leave, family medical leave, health benefits, membership or membership discounts, moving expenses, pension and retirement benefits or travel benefits (collectively "Core Benefits") as well as any benefits other than the Core Benefits between employees with domestic partners and employees with spouses, and/or between the domestic partners and spouses of such employees, where the domestic partnership has been registered with a governmental entity pursuant to state or local law authorizing such registration, subject to the conditions set forth in the Agency's Non-Discrimination in Contracts and Benefits Policy, adopted September 9, 1997, as amended February 4, 1998.

26.3 First Source Hiring Ordinance.

As part of the Equal Opportunity Program, Tenant shall comply with requirements for construction workforce hiring, minority- and women-owned businesses, use and occupancy and permanent work force, as well as requirements to promote the employment of qualified economically disadvantaged residents of the City in permanent jobs created in the Premises pursuant to the City's First Source Hiring Ordinance (Board of Supervisors Ordinance No. 264-98). Tenant shall comply with the "First Consideration for Employment" requirements stated in Attachment 24 to the DDA with respect to the operation and leasing of the Premises. Tenant shall (i) attach and incorporate by reference the relevant provisions of such

Attachment 24 in Subleases or other occupancy agreements for the Premises, (ii) make commercially reasonable efforts to enforce such provisions, and (iii) provide the Agency with a direct right of enforcement.

26.4 Compliance with Minimum Compensation Policy and Health Care Accountability Policy.

Tenant agrees, as of the date of this Lease and during the term of this Lease, to comply with the provisions of the Agency's Minimum Compensation Policy and Health Care Accountability Policy (the "Policies"), adopted by Agency Resolution 164-2001, as such policies may be amended from time to time. Such compliance includes providing all "Covered Employees," as defined under Section 2.7 of the Policies, a minimum level of compensation and offering health plan benefits to such employees or to make payments to the City's Department of Public Health, or to participate in a health benefits program developed by the City's Director of Health.

26.5 Labor Relations.

The following provisions shall apply to any restaurant or hotel facility located on the Premises. The Agency has a significant proprietary interest in the Premises, which the Agency will lease to Tenant. The economic resources to be committed by Agency or made available through Agency assistance may be put at risk by labor/management conflicts. In order to protect its proprietary interests if such conflicts occur, Agency has adopted a Card Check Neutrality Policy, which is consistent with the City's Employee Signature Authorization Ordinance (San Francisco Administrative Code Section 23.31 through 23.35) (the "Card Check Neutrality Policy"). Accordingly, Tenant agrees as follows:

(a) Tenant acknowledges that Agency's Card Check Neutrality Policy requires employers of at least fifty (50) employees in hotel and restaurant uses (jointly "Hotel/Restaurant Operator") to comply with the requirements of such Card Check Neutrality Policy to the extent applicable to hotel and restaurant uses in or on the Premises; provided, however, that the failure of any such Hotel/Restaurant Operator to comply with the requirements of such Card Check Neutrality Policy shall not constitute a default by Tenant hereunder, so long as Tenant has imposed the requirement to do so in the Sublease or other applicable document with such Hotel/Restaurant Operator.

(b) The Agency's failure to require compliance with Agency's Card Check Neutrality Policy shall not constitute a waiver, nor shall such delay or inaction be deemed to constitute a release from such obligation or from liability for any failure to so comply, and Agency shall have the right to enforce such requirements directly against the non-complying Subtenant or Hotel/Restaurant Operator.

26.6 Mitigation Measures.

In order to mitigate the significant environmental impacts of this Lease and Construction on and operation of the Premises, Tenant agrees that such Construction and operation shall be in accordance with the Mitigation Measures to the extent applicable to the activities performed on

the Premises. As appropriate, Tenant shall incorporate such Mitigation Measures into any contract for the Construction or operation of the Improvements.

26.7 Waiver of Relocation Assistance Rights.

If Tenant holds over in possession of the Premises following the expiration of this Lease under Section 22.2, Tenant shall not be entitled, during the period of any such holdover, to rights, benefits or privileges under the California Relocation Assistance Law, California Government Code Section 7260 et seq., or the Uniform Relocation Assistance and Real Property Acquisition Policies Act, 42 U.S.C. Section 4601 et seq., or under any similar Law, statute or ordinance now or hereafter in effect, except as provided in Article 14 relating to Condemnation, and Tenant hereby waives any entitlement to any such rights, benefits and privileges with respect to any such holdover period.

26.8 Prevailing Wage Provisions.

Tenant shall comply with the Prevailing Wage Provisions.

ARTICLE 27. GENERAL.

27.1 Time of Performance.

All performance dates (including cure dates) expire at 5:00 p.m., San Francisco, California time, on the performance or cure date. A performance date which falls on a Saturday, Sunday or City holiday is deemed extended to 5:00 p.m. the next working day. All periods for performance or notices specified herein in terms of days shall be calendar days, and not business days, unless otherwise provided herein. Time is of the essence with respect to each provision of this Lease, including, but not limited, the provisions for the exercise of any option on the part of Tenant hereunder and the provisions for the payment of Rent and any other sums due hereunder.

27.2 Interpretation of Agreement.

Whenever an "Exhibit" is referenced, it means an attachment to this Lease unless otherwise specifically identified. All such Exhibits are incorporated herein by reference. Whenever a section, article or paragraph is referenced, it refers to this Lease unless otherwise specifically identified. The captions preceding the articles and sections of this Lease and in the table of contents have been inserted for convenience of reference only. Such captions shall define or limit the scope or intent of any provision of this Lease. The use of the term "including," "such as" or words of similar import when following any general term, statement or matter shall not be construed to limit such term, statement or matter to the specific items or matters, whether or not language of non-limitation is used with reference thereto. Rather, such terms shall be deemed to refer to all other items or matters that could reasonably fall within the broadest possible scope of such statement, term or matter. This Lease has been negotiated at arm's length and between persons sophisticated and knowledgeable in the matters dealt with herein. In addition, each Party has been represented by experienced and knowledgeable legal counsel. Accordingly, this Lease shall be interpreted to achieve the intents and purposes of the Parties, without any presumption against the Party responsible for drafting any part of this Lease

(including, but not limited to, California Civil Code Section 1654). The Party on which any obligation is imposed in this Lease shall be solely responsible for paying all costs and expenses incurred in the performance thereof, unless the provision imposing such obligation specifically provides to the contrary. Wherever reference is made to any provision, term or matter "in this Lease," "herein" or "hereof" or words of similar import, the reference shall be deemed to refer to any and all provisions of this Lease reasonably related thereto in the context of such reference, unless such reference refers solely to a specific numbered or lettered , section or paragraph of this Lease or any specific subdivision thereof. Unless otherwise specifically stated in this Lease, wherever a Party hereto has a right of approval or consent, such approval or consent shall not be unreasonably withheld, conditioned or delayed.

27.3 Relationship of Lease to ENA and/or DDA.

This Lease describes the rights and obligations of Tenant and Agency with regard to the Premises during the Term. The DDA will govern the development of the DDA Improvements in the event of any inconsistency between this Lease and the DDA.

27.4 Successors and Assigns.

This Lease is binding upon and will inure to the benefit of the successors and assigns of the Parties. Where the term "Tenant" or "Agency" is used in this Lease, it means and includes their respective successors and assigns. Whenever this Lease specifies or implies Agency as a Party or the holder of the right or obligation to give approvals or consents, if Agency or a comparable public body which has succeeded to Agency's rights and obligations no longer exists, then the City will be deemed to be the successor and assign of Agency for purposes of this Lease.

27.5 Estoppel Certificate by Agency.

Agency shall execute, acknowledge and deliver to Tenant (or at Tenant's request, to any Subtenant, prospective Subtenant, or other prospective transferee of Tenant's interest under this Lease), within twenty (20) business days after a request, a certificate stating to the best of Agency's knowledge after diligent inquiry (a) that this Lease is unmodified and in full force and effect (or, if there have been modifications, that this Lease is in full force and effect as modified, and stating the modifications or if this Lease is not in full force and effect, so stating), (b) the dates, if any, to which Rent and other sums payable hereunder have been paid, (c) whether or not, to the knowledge of Agency, there are then existing any defaults under this Lease (and if so, specifying the same) and (d) any other matter actually known to Agency, directly related to this Lease and reasonably requested by the requesting Party. In addition, if requested, Agency shall attach to such certificate a copy of this Lease and any amendments thereto, and include in such certificate a statement by Agency that, to the best of its knowledge, such attachment is a true, correct and complete copy of this Lease, including all modifications thereto. Any such certificate may be relied upon by Tenant or any Subtenant, prospective Subtenant, or other prospective transferee of Tenant's interest under this Lease.

27.6 Approvals by Agency.

The Agency's Executive Director or his or her designee, is authorized to execute on behalf of Agency any closing or similar documents and any contracts, agreements, memoranda or similar documents with State, regional or local authorities or other Persons that are necessary or proper to achieve the purposes and objectives of this Lease and do not materially increase the obligations of Agency hereunder, if the Executive Director determines, after consultation with, and approval as to form by, the Agency's General Counsel, that the document is necessary or proper and in Agency's best interests. The Agency Executive Director's signature of any such documents shall conclusively evidence such a determination by him or her. Wherever this Lease requires or permits the giving by Agency of its consent or approval, or whenever an amendment, waiver, notice, or other instrument or document is to be executed by or on behalf of Agency, the Executive Director, or his or her designee, shall be authorized to execute such instrument on behalf of Agency, except as otherwise provided by applicable Law.

27.7 Fees for Review.

Within thirty (30) days after Agency's written request, Tenant shall pay Agency, as Additional Rent, Agency's reasonable costs, including, without limitation, Attorneys' Fees and Costs (and including fees and costs of the Agency's General Counsel) incurred in connection with the review, investigation, processing, documentation and/or approval of any proposed assignment or Sublease, estoppel certificate, Non-disturbance Agreement and Construction. Tenant shall pay such reasonable costs regardless of whether or not Agency consents to such proposal, except only in any instance where Agency has wrongfully withheld, delayed or conditioned its consent in violation of this Lease.

27.8 No Merger of Title.

There shall be no merger of the Leasehold Estate with the fee estate in the Premises by reason of the fact that the same Person may own or hold (a) the Leasehold Estate or any interest in such Leasehold Estate, and (b) any interest in such fee estate. No such merger shall occur unless and until all Persons having any interest in the Leasehold Estate and the fee estate in the Premises shall join in and record a written instrument effecting such merger.

27.9 Quiet Enjoyment.

Subject to the terms and conditions of this Lease and applicable Laws, Agency agrees that Tenant, upon paying the Rent and observing and keeping all of the covenants under this Lease on its part to be kept, shall lawfully and quietly hold, occupy and enjoy the Premises during the Term of this Lease without hindrance or molestation of anyone claiming by, through or under Agency. Notwithstanding the foregoing, Agency shall have no liability to Tenant in the event any defect exists in the title of Agency as of the Commencement Date, whether or not such defect affects Tenant's rights of quiet enjoyment (unless such defect is due to Agency's willful misconduct) and, except as otherwise expressly provided for under the terms and provisions of this Lease, no such defect shall be grounds for a termination of this Lease by Tenant. Tenant's sole remedy with respect to any such existing title defect shall be to obtain compensation by

) pursuing its rights against any title insurance company or companies issuing title insurance policies to Tenant.

27.10 No Third Party Beneficiaries.

This Lease is for the exclusive benefit of the Parties hereto and not for the benefit of any other Person and shall not be deemed to have conferred any rights, express or implied, upon any other Person.

27.11 Real Estate Commissions.

Neither Agency nor Tenant shall be liable for any real estate commissions, brokerage fees or finder's fees which may arise from this Lease. Tenant and Agency each represents that it engaged no broker, agent or finder in connection with this transaction. In the event any broker, agent or finder makes a claim, the Party through whom such claim is made agrees to Indemnify the other Party from any Losses arising out of such claim.

27.12 Counterparts.

This Lease may be executed in counterparts, each of which is deemed to be an original, and all such counterparts constitute one and the same instrument.

27.13 Entire Agreement.

) This Lease (including the Exhibits), the ENA and/or DDA, for so long as such agreement(s) is in effect, constitute the entire agreement between the Parties with respect to the subject matter set forth therein, and supersede all negotiations or previous agreements between the Parties with respect to all or any part of the terms and conditions mentioned herein or incidental hereto. No parol evidence of any prior or other agreement shall be permitted to contradict or vary the terms of this Lease.

27.14 Amendment.

Neither this Lease nor any of the terms hereof may be terminated, amended or modified except by a written instrument executed by the Parties.

27.15 Governing Law; Selection of Forum.

) This Lease shall be governed by, and interpreted in accordance with, the laws of the State of California. As part of the consideration for Agency's entering into this Lease, Tenant agrees that all actions or proceedings arising directly or indirectly under this Lease may, at the sole option of Agency, be litigated in courts having situs within the State of California, and Tenant consents to the jurisdiction of any such local, state or federal court, and consents that any service of process in such action or proceeding may be made by personal service upon Tenant wherever Tenant may then be located, or by certified or registered mail directed to Tenant at the address set forth herein for the delivery of notices.

27.16 Recordation.

This Lease will not be recorded by either Party. The Parties agree to execute and record in the Official Records a Memorandum of Lease substantially in the form attached hereto as Exhibit H. Promptly upon Agency's request following the expiration of the Term or any other termination of this Lease, Tenant shall deliver to Agency a duly executed and acknowledged quitclaim deed suitable for recordation in the Official Records and in form and content satisfactory to Agency and the Agency's General Counsel, for the purpose of evidencing in the public records the termination of Tenant's interest under this Lease. Agency may record such quitclaim deed at any time on or after the termination of this Lease, without the need for any approval or further act of Tenant.

27.17 Extensions by Agency.

Upon the request of Tenant, Agency may, by written instrument, extend the time for Tenant's performance of any term, covenant or condition of this Lease or permit the curing of any default upon such terms and conditions as it determines appropriate, including but not limited to, the time within which Tenant must agree to such terms and/or conditions, provided, however, that any such extension or permissive curing of any particular default will not operate to release any of Tenant's obligations nor constitute a waiver of Agency's rights with respect to any other term, covenant or condition of this Lease or any other default in, or breach of, this Lease or otherwise effect the time of the essence provisions with respect to the extended date or other dates for performance hereunder.

27.18 Further Assurances.

The Parties hereto agree to execute and acknowledge such other and further documents as may be necessary or reasonably required to express the intent of the Parties or otherwise effectuate the terms of this Lease. The Executive Director of the Agency is authorized to execute on behalf of the Agency any closing or similar documents and any contracts, agreements, memoranda or similar documents with Tenant, State, regional and local entities or enter into any tolling agreement with any Person that are necessary or proper to achieve the purposes and objectives of this Lease, if the Executive Director determines that the document or agreement is necessary or proper and is in the Agency's best interests.

27.19 Attorneys' Fees.

Except as provided in Section 19.5 with regard to an arbitration proceeding, if either Party hereto fails to perform any of its respective obligations under this Lease or if any dispute arises between the Parties hereto concerning the meaning or interpretation of any provision of this Lease, then the defaulting Party or the Party not prevailing in such dispute, as the case may be, shall pay any and all costs and expenses incurred by the other Party on account of such default and/or in enforcing or establishing its rights hereunder, including, without limitation, reasonable Attorneys' Fees and Costs. Any such Attorneys' Fees and Costs incurred by either Party in enforcing a judgment in its favor under this Lease shall be recoverable separately from and in addition to any other amount included in such judgment, and such Attorneys' Fees and Costs obligation is intended to be severable from the other provisions of this Lease and to

survive and not be merged into any such judgment. For purposes of this Lease, the reasonable fees of attorneys of Agency's General Counsel shall be based on the fees regularly charged by private attorneys with the equivalent number of years of experience in the subject matter area of the law for which the Agency's General Counsel's services were rendered who practice in the City of San Francisco in law firms with approximately the same number of attorneys as employed by the Agency's General Counsel's Office. If Tenant utilizes services of in-house counsel, then, for purposes of this Lease, the reasonable fees of such in-house counsel shall be based on the fees regularly charged by private attorneys with the equivalent number of years of experience in the subject matter area of the law for which the in-house counsel's services were rendered who practice in the City of San Francisco in full service law firms.

27.20 Effective Date.

This Lease shall become effective on the date (the "Effective Date") the Parties duly execute and deliver this Lease following approval by the Agency's Commission, in its sole and absolute discretion. The Effective Date will be inserted by Agency on the cover page and on page 1 hereof, provided, however, that Agency's failure to insert the Effective Date shall not invalidate this Lease. Where used in this Lease or in any of its exhibits, references to "the date of this Lease," the "reference date of this Lease," "Lease Date" or "Effective Date" will mean the Effective Date determined as set forth above and shown on the first page hereof.

27.21 Severability.

If any provision of this Lease, or its application to any Person or circumstance, is held invalid by any court, the invalidity or inapplicability of such provision shall not affect any other provision of this Lease or the application of such provision to any other Person or circumstance, and the remaining Portions of this Lease shall continue in full force and effect, unless enforcement of this Lease as so modified by and in response to such invalidation would be grossly inequitable under all of the circumstances, or would frustrate the fundamental purposes of this Lease.

27.22 Force Majeure Extensions.

(a) Postponement. A Party who is subject to Force Majeure in the performance of an obligation hereunder, or in the satisfaction of a condition to the other Party's performance hereunder, shall be entitled to a postponement of the time for performance of such obligation or satisfaction of such condition during the period of enforced delay attributable to an event of Force Majeure, subject to the provisions of this Section 27.22.

(b) Notice of Enforced Force Majeure. The Force Majeure provisions of this Section shall not apply unless (i) the Party seeking to rely upon such provisions shall have given notice to the other Party, within thirty (30) days after obtaining knowledge of the beginning of an event of Force Majeure, of such delay and the cause or causes thereof, to the extent known and (ii) a party claiming the Force Majeure must at all times be acting diligently and in good faith to avoid foreseeable delays in performance, and to remove the cause of the delay or to develop a reasonable alternative means of performance.

(c) Extensions. The Agency or Tenant may extend time for the other Party's performance of any term, covenant or condition of this Agreement or permit the curing of any default upon such terms and conditions as it determines appropriate; provided, however, that any such extension or permissive curing of any particular default shall not operate to release any of the other Party's obligations nor constitute a waiver of the extending Party's rights with respect to any other term, covenant or condition of this Agreement or any other Event of Default under this Agreement.

In addition to matters set forth in the immediately preceding paragraph, the Parties may extend the time for performance by either or both Parties of any term, covenant or condition of this Agreement by a written instrument signed by authorized representatives of both Parties without the execution of a formal recorded amendment to this Agreement, and any such written instrument shall have the same force and effect and impart the same notice to third parties as a formal recorded amendment to this Agreement.

ARTICLE 28. DEFINITIONS.

For purposes of this Lease, initially capitalized terms shall have the meanings ascribed to them in this Article:

Access Easement as defined in Section 4.3(a)(ii).

Active Premises as defined in Section 1.3.

Additional Rent means any and all sums (other than Percentage Rent) that may become due or be payable by Tenant under this Lease.

Adjusted Gross Receipts means for each calendar quarter all amounts received and receivable from all sales, services and business transacted by Tenant on the Premises, or services performed on the Premises for which charge is made by Tenant or its Permitted Licensees conducting sales or performing services of any sort in, upon, or from any part of the Premises, and shall include, without limitation thereto: (i) any fee, charge or amount collected by Tenant or Permitted Licensee, whether for cash or credit (and regardless of collections in the case of the latter), plus, if parking for vehicles is provided for free or on a discounted, validated basis, Imputed Revenue (as defined below) in respect of such free or discounted, validated parking; or (ii) the gross sales price of merchandise, services or food: provided however, that the following shall be excluded from Adjusted Gross Receipts: (x) actual returns and refunds; (y) the amount of any sales tax, or similar tax or Imposition imposed on such sales or charges where such sale tax or similar tax or Imposition is billed to the purchaser as a special item; and (z) parking taxes, specifically including taxes payable pursuant to the City and County Parking Tax Ordinance, Part III, Article 9, Sections 601-618 of the San Francisco Municipal Code, or any similar, substitute or successor tax. For the purposes of this paragraph, "Imputed Revenue" shall mean the retail value of any parking at a comparable commercial parking facility in the surrounding area (less, in the case of discounted, validated parking, the amount of any fee, charge or amount collected therefor by Tenant or Permitted Licensees which amount is otherwise included in Gross Receipts).

Affiliate means any Person directly or indirectly Controlling, Controlled by or under Common Control with the other Person in question.

Agency means the Redevelopment Agency of the City and County of San Francisco.

Agents means, when used with reference to either Party to this Lease, the members, officers, directors, commissioners, employees, agents and contractors of such Party, and their respective heirs, legal representatives, successors and assigns.

Arbiter as defined in Section 19.5.

Artist and Artists as defined in Section 15.4.

Artist's Space and Artists' Space as defined in Section 1.1(c).

Attorneys' Fees and Costs means reasonable attorneys' fees, costs, expenses and disbursements, including, but not limited to, expert witness fees and costs, travel time and associated costs, transcript preparation fees and costs, document copying, exhibit preparation, courier, postage, facsimile, long-distance and communications expenses, court costs and other reasonable costs and fees associated with any other legal, administrative or alternative dispute resolution proceeding, including such fees and costs associated with execution upon any judgment or order, and costs on appeal.

Card Check Neutrality Policy as defined in Section 26.5.

Casualty Notice as defined in Section 13.4(a)(i).

Certificate of Completion as defined and as described below in the definition of "Completion".

City means the City and County of San Francisco, a municipal corporation. City shall refer to the City operating by and through its Agency Commission, where appropriate. All references to City shall include the Agency.

Commencement Date as defined in Section 1.2.

Common Areas means the portions of the Premises, if any, which are designated as Common Areas in an instrument executed by Tenant and Agency.

Completion means completion of construction of all or any applicable portion of the Improvements. The fact of Completion shall be conclusively evidenced by the issuance of a Certificate of Completion.

Condemnation means the taking or damaging, including severance damage, of all or any part of any property, or the right of possession thereof, by eminent domain, inverse condemnation, or for any public or quasi-public use under the Law. Condemnation may occur pursuant to the recording of a final order of condemnation, or by a voluntary sale of all or any part of any property to any Person having the power of eminent domain (or to a designee of any

such Person), provided that the property or such part thereof is then under the threat of condemnation or such sale occurs by way of settlement of a condemnation action.

Condemnation Award means all compensation, sums or value paid, awarded or received for, or on account of, a Condemnation, whether pursuant to judgment, agreement, settlement or otherwise.

Condemnation Date means the earlier of: (a) the date when the right of possession of the condemned property is taken by the condemning authority; or (b) the date when title to the condemned property (or any part thereof) vests in the condemning authority.

Construction means all repairs to and reconstruction, replacement, addition, expansion, Restoration, alteration or modification of any Improvements, or any construction of additional Improvements.

Control means the ownership (direct or indirect) by one Person of more than fifty percent (50%) of the profits or capital of another Person, and Controlled and Controlling have correlative meanings. Common Control means that two Persons are both Controlled by the same other Person.

Conveyance Agreement means that certain Conveyance Agreement between the United States of America Acting by and through the Secretary of the Navy United States Department of the Navy and the San Francisco Redevelopment Agency for the Conveyance of Hunters Point Naval Shipyard, dated as of March 31, 2004.

Core Benefits as defined in Section 26.2(b).

Cost of Living Index as defined in Section 2.3(a), means the Consumer Price Index for All Urban Consumers (base years 1982-1984 = 100) for the San Francisco-Oakland-San Jose area, published by the United States Department of Labor, Bureau of Labor Statistics. If the Index is changed so that the base year differs from that used as of the date most immediately preceding the Commencement Date, the Index shall be converted in accordance with the conversion factor published by the United States Department of Labor, Bureau of Labor Statistics. If the Index is discontinued or revised during the Term, such other government index or computation with which it is replaced shall be used in order to obtain substantially the same result as would be obtained if the Index had not been discontinued or revised.

DDA as defined in Recital H.

Default Rate shall mean the annual rate of interest equal to the greater of (i) ten percent (10%) or (ii) five percent (5%) in excess of the rate the Federal Reserve Bank of San Francisco charges, as of the date payment is due, on advances to member banks and depository institutions under Section 13 and 14a of the Federal Reserve Act. However, interest shall not be payable hereunder to the extent such payment would violate any applicable usury or similar law.

Disabled Access Laws means all Laws related to access for persons with disabilities including, without limitation, the Americans with Disabilities Act, 42 U.S.C.S. Section 12101 et seq. and disabled access laws under the Agency's building code.

Effective Date as defined in Section 27.20.

Equal Opportunity Program as defined in Section 26.2.

Event of Default as defined in Section 17.1.

Executive Director means the Executive Director of the Agency or his or her designee.

First Consideration for Employment as defined in Section 26.3.

Force Majeure means events which result in delays in a Party's performance of its obligations hereunder due to causes beyond such Party's control, including, but not restricted to, acts of God or of the public enemy, acts of the government, acts of the other Party, fires, floods, earthquakes, tidal waves, strikes, freight embargoes, delays of subcontractors and unusually severe weather. Force Majeure does not include failure to obtain financing or have adequate funds. The delay caused by Force Majeure includes not only the period of time during which performance of an act is hindered, but also such additional time thereafter as may reasonably be required to make repairs, to Restore if appropriate, and to complete performance of the hindered act.

FOST means a Finding of Suitability to Transfer.

Governmental Entity means any government or governmental or regulatory body thereof, or political subdivision thereof, whether federal, state, local or foreign, or any instrumentality thereof or any court or arbitrator (public or private).

Handle when used with reference to Hazardous Materials means to use, generate, manufacture, process, produce, package, treat, transport, store, emit, discharge or dispose of any Hazardous Material ("Handling" will have a correlative meaning).

Hazardous Material means any material that, because of its quantity, concentration or physical or chemical characteristics, is deemed by any federal, state or local governmental authority to pose a present or potential hazard to human health or safety or to the environment. Hazardous Material includes, without limitation, any material or substance defined as a "hazardous substance," or "pollutant" or "contaminant" under the Comprehensive Environmental Response, Compensation and Liability Act of 1980 ("CERCLA", also commonly known as the "Superfund" law), as amended, (42 U.S.C. Section 9601 et seq.) or under Section 25281 or Section 25316 of the California Health & Safety Code; any "hazardous waste" as defined in Section 25117 or listed under Section 25140 of the California Health & Safety Code; any asbestos and asbestos containing materials whether or not such materials are part of the structure of any existing Improvements on the Premises, any Improvements to be constructed on the Premises by or on behalf of Tenant, or are naturally occurring substances on, in or about the Premises and petroleum, including crude oil or any fraction, and natural gas or natural gas liquids.

Hazardous Material Claims means any and all enforcement, Investigation, Remediation or other governmental or regulatory actions, agreements or orders threatened, instituted or completed under any Environmental Laws, together with any and all Losses made or threatened by any third party against City, including the Agency, their Agents, or the Premises or any

Improvements, relating to damage, contribution, cost recovery compensation, loss or injury resulting from the presence, release or discharge of any Hazardous Materials, including, without limitation, Losses based in common law. Hazardous Material Claims include, without limitation, Investigation and Remediation costs, fines, natural resource damages, damages for decrease in value of the Premises or any Improvements, the loss or restriction of the use or any amenity of the Premises or any Improvements, and attorneys' fees and consultants' fees and experts' fees and costs.

Hazardous Material Laws means any present or future federal, state or local Laws relating to Hazardous Material (including, without limitation, its Handling, transportation or Release) or to human health and safety, industrial hygiene or environmental conditions in, on, under or about the Premises (including the Improvements), including, without limitation, soil, air, air quality, water, water quality and groundwater conditions. Hazardous Materials Laws include, but are not limited to, the City's Pesticide Ordinance (Chapter 39 of the San Francisco Administrative Code), to the extent applicable to tenants of Agency property on the effective date of Article 20 of the San Francisco Public Works Code ("Analyzing Soils for Hazardous Waste").

Hotel/Restaurant Operator as defined in Section 26.5.

Impositions as defined in Section 8.1(b).

Improvements means all buildings, structures, fixtures and other improvements erected, built, placed, installed or constructed upon or within the Premises, including, but not limited to, all streets, curbs, paving, surfacing, sewers, storm drains and other improvements which may now or hereafter be located on the Premises, including, without limitation thereto, the Health and Safety Improvements.

Indebtedness of any Person, shall mean all items of indebtedness which, in accordance with generally accepted accounting principles, would be included in determining liabilities as shown on the liability side of the balance sheet of such Person as of the date as of which Indebtedness is to be determined, including, without limitation thereto, (i) Indebtedness for borrowed money or for the deferred purchase price of property or services in respect of which such Person is liable, contingently or otherwise, as obligor, guarantor or otherwise, or in respect of which such Person otherwise assures a creditor against loss, and (ii) obligations of such Person under leases which shall have been or should be, in accordance with generally accepted accounting principles, recorded as capital leases.

Indemnified Parties means the Agency and the City, including, but not limited to, all of its boards, commissions, departments, agencies and other subdivisions, all of the Agents of the Agency, City, and all of their respective heirs, legal representatives, successors and assigns, and each of them.

Indemnify means indemnify, protect and hold harmless.

Index means the Consumer Price Index for All Urban Consumers (base years 1982-1984 = 100) for the San Francisco-Oakland-San Jose area, published by the United States Department of Labor, Bureau of Labor Statistics. If the Index is modified during the Term hereof, the

modified Index shall be used in place of the original Index. If compilation or publication of the Index is discontinued during the Term, Agency shall select another similar published index, generally reflective of increases in the cost of living, subject to Tenant's approval, which shall not be unreasonably withheld or delayed, in order to obtain substantially the same result as would be obtained if the Index had not been discontinued.

Indexed means the product of the number to be Indexed multiplied by the percentage increase, if any, in the Index from the first day of the month in which the Commencement Date occurred to the first day of the most recent month for which the Index is available at any given time.

Investigate or Investigation when used with reference to Hazardous Material means any activity undertaken to determine the nature and extent of Hazardous Material that may be located in, on, under or about the Premises, any Improvements or any portion of the site or the Improvements or which have been, are being, or threaten to be Released into the environment. Investigation shall include, without limitation, preparation of site history reports and sampling and analysis of environmental conditions in, on, under or about the Premises or any Improvements.

Invitees when used with respect to Tenant or Subtenants means its customers, patrons, invitees, guests, members, licensees, assignees.

Law or Laws means any one or more present and future laws, ordinances, rules, regulations, permits, authorizations, orders and requirements, to the extent applicable to the Premises or to the Parties' use of the Premises or any portion thereof, whether or not in the present contemplation of the Parties, including, without limitation, all consents or approvals (including Regulatory Approvals) required to be obtained from, and all rules and regulations of, and all building and zoning laws of, all federal, state, county and municipal governments, the departments, bureaus, agencies or commissions thereof, authorities, boards of officers, any national or local board of fire underwriters, or any other body or bodies exercising similar functions, having or acquiring jurisdiction of, or which may affect or be applicable to, the Premises or any part thereof, including, without limitation, any subsurface area, the use thereof and of the buildings and Improvements thereon.

Lease means this Interim Lease, as it may be amended from time to time.

Leasehold Estate means Tenant's leasehold estate created by this Lease.

Loss or Losses when used with reference to any Indemnity means any and all claims, demands, losses, liabilities, damages (including foreseeable and unforeseeable consequential damages), liens, obligations, interest, injuries, penalties, fines, lawsuits and other proceedings, judgments and awards and costs and expenses, (including, without limitation, reasonable Attorneys' Fees and Costs and consultants' fees and costs) of whatever kind or nature, known or unknown, contingent or otherwise.

Major Alterations as defined in Section 5.3.

) Memorandum of Lease means any memorandum of this Lease, between Agency and Tenant, recorded in the Official Records.

Minimum Rent as defined in Section 3.2.

Minor Alterations as defined in Section 5.3.

Mitigation Measures means all of the measures described in Attachment 11 to the DDA.

Mortgage means a mortgage, deed of trust, assignment of rents, fixture filing, security agreement or similar security instrument or assignment of Tenant's leasehold interest under this Lease that is recorded in the Official Records.

Navy Utilities Agreement shall mean that certain Navy Utilities Agreement, dated December 3, 2004 by and between the United States of America, acting by and through the Department of the Navy, and the Agency.

Net Awards and Payments as defined in Section 14.4.

) Net Operating Income means the Adjusted Gross Receipts and any other revenues or receipts of the Tenant directly or indirectly generated or derived from, or related to, Tenant's use and/or occupancy of the Premises, less (i) Tenant's actual reasonable operating and administrative expenses and costs relating to this Lease, and (ii) Tenant's actual and reasonable costs of making capital improvements and repairs to the Premises, including any accrued but unreimbursed capital improvements and repair costs incurred during the Term and any prospective capital improvements and repair costs approved by Tenant and Agency in writing, excepting Debt Service and costs that are not otherwise excluded in the calculation of Adjusted Gross Receipts (as hereinabove defined). For purposes of this paragraph, "Debt Service" shall mean, for any period for which calculation is made, the aggregate of the payment obligations of the Tenant or any Permitted Licensee in respect of Indebtedness (as hereinabove defined) during such period, whether such obligations relate to principal, interest, fees or other amounts required to be paid in respect of such Indebtedness.

Non-Disturbance Agreements as defined in Section 15.5(a).

Official Records means, with respect to the recordation of Mortgages and other documents and instruments, the Official Records of the City and County of San Francisco.

Order means any order, injunction, judgment, decree, ruling, writ, assessment or arbitration award.

Parcel or Parcels as defined in Recital E.

Partial Condemnation as defined in Section 14.3.

) Partial Termination Agreement as defined in Section 4.3(a)(ii).

Party means Agency or Tenant, as a party to this Lease; Parties means both Agency and Tenant, as Parties to this Lease.

Passive Premises as defined in Section 1.3.

Percentage Rent as defined in Section 3.3.

Permitted Licensee as defined in Section 2.3(b).

Permitted Uses as defined in Section 2.1.

Person means any individual, partnership, corporation (including, but not limited to, any business trust), limited liability company, joint stock company, trust, unincorporated association, joint venture or any other entity or association, the United States, or a federal, state or political subdivision thereof.

Personal Property means all fixtures, furniture, furnishings, equipment, machinery, supplies, software and other tangible personal property that is incident to the ownership, development or operation of the Improvements and/or the Premises, whether now or hereafter located in, upon or about the Premises, belonging to Tenant and/or in which Tenant has or may hereafter acquire an ownership interest, together with all present and future attachments, accessions, replacements, substitutions and additions thereto or therefor.

Premises as defined in Section 1.1.

Prevailing Wage Provisions means the Prevailing Wage Requirements contained in Attachment 13 to the DDA.

Property as defined in Section 1.1.

Public Trust means the tidelands public trust for commerce, navigation and fisheries.

Regulatory Approval means any authorization, approval or permit required for any construction, improvement, repair, maintenance, use or occupancy of the Premises by any Governmental Entity (or agency thereof) having jurisdiction over the Premises, including, but not limited to, the City, BCDC, RWQCB, and the Army Corps of Engineers.

Release when used with respect to Hazardous Material means any spilling, leaking, pumping, pouring, emitting, emptying, discharging, injecting, escaping, leaching, dumping, or disposing into or inside any existing improvements or any Improvements constructed under this Lease by or on behalf of Tenant, or in, on, under or about the Premises or any portion thereof.

Remediate or Remediation when used with reference to Hazardous Materials means any activities undertaken to clean up, remove, transport, dispose, contain, treat, stabilize, monitor or otherwise control Hazardous Materials located in, on, under or about the Premises or which have been, are being, or threaten to be Released into the environment. Remediation includes, without limitation, those actions included within the definition of "remedy" or "remedial action" in

California Health and Safety Code Section 25322 and "remove" or "removal" in California Health and Safety Code Section 25323.

Rent means the sum of Percentage Rent, and Additional Rent. For purposes of this Lease, Rent includes all unpaid sums that are payable as Rent, but that are unpaid when earned and/or accrue for payment at a later time in accordance with the provisions of this Lease.

Restoration means the restoration, replacement, or rebuilding of the Improvements in accordance with all Laws then applicable (including code upgrades) to substantially the same condition they were in immediately before an event of damage or destruction or, in the case of Condemnation, the restoration, replacement, or rebuilding of the Improvements to an architectural whole. ("Restore" and "Restored" shall have correlative meanings.) Notwithstanding the foregoing, in the event of a Significant Damage or Destruction occurring at any time during the Term, then Tenant shall not be required to Restore the Improvements to the identical size or configuration as existed before the event giving rise to the Restoration so long as the Improvements as Restored, constitute a first-call project.

RWQCB shall mean the San Francisco Bay Regional Water Quality Control Board of Cal/EPA, a state agency.

Schedule of Performance as defined in Section 5.1.

Security Cooperative Agreement means that certain Security Services Cooperative Agreement between the United States of America Acting by and through the Secretary of the Navy United States Department of the Navy and the San Francisco Redevelopment Agency for the provision of Security Services to the Hunters Point Naval Shipyard, effective as of October 1, 2004.

Security Deposit as defined in Section 3.8(a).

Significant Change means any dissolution, merger, consolidation or other reorganization, or any issuance or transfer of beneficial interests in Tenant, directly or indirectly, in one or more transactions, that results in a change in the identity of Persons Controlling Tenant, provided that a Significant Change will not include the Transfer of beneficial interests ownership interests in any Person as a result of the trading of shares on the open-market where such Person is a publicly-traded company. The sale of fifty percent (50%) or more of Tenant's assets, capital or profits, or the assets, capital or profit of any Person Controlling Tenant except to an Affiliate shall also be a Significant Change (other than as the result of the trading of shares of a publicly-traded Persons as provided above).

Significant Damage or Destruction means damage to or destruction of all or any portion of the Improvements (together with any Subsequent Improvements) on the Premises to the extent that the hard costs of Restoration will exceed seventy five percent (75%) of the hard costs to replace such Improvements on the Premises in their entirety. The calculation of such percentage shall be based upon replacement costs and requirements of applicable Laws in effect as of the date of the event causing such Significant Damage or Destruction.

Soil and Groundwater Management Plan as defined in Section 6.6(c)8 of the DDA and codified in the City's Health Code Article 31.

State as defined in Section 1.1(d).

State Lands Parcel as defined in Section 4.4.

Sublease means any lease, sublease, sub-sublease, license, concession or other agreement by which Tenant leases, subleases, sub-subleases, demises, licenses or otherwise grants to any Person in conformity with the provisions of this Lease, the right to occupy or use any portion of the Premises (whether in common with or to the exclusion of other Persons).

Subleased Premises as defined in Section 15.3.

Subtenant means any Person leasing, occupying or having the right to occupy any portion of the Premises under and by virtue of a Sublease.

Tenant means LENNAR–BVHP, LLC, a California limited liability company doing business as Lennar BVHP Partners, and its permitted successors and assigns.

Term as defined in Section 1.2.

Total Condemnation as defined in Section 14.2.

Uninsured Casualty as defined in Section 13.4(a)(i).

Utilities Agreement as defined in Section 5.4.

IN WITNESS WHEREOF, the Parties hereto have caused this Lease to be duly executed by their respective authorized officers as of the date and year first written above.

"AGENCY"

REDEVELOPMENT AGENCY OF THE CITY
AND COUNTY OF SAN FRANCISCO,
a public body, corporate and politic

By: Marcia Rosen
Marcia Rosen
Its: Executive Director

Approved as to Form:

Agency General Counsel

By: James B. Morales
James B. Morales
Its: General Counsel

Authorized by Agency Resolution No. 179-2003

Adopted December 2, 2003

"TENANT"

LENNAR/BVHP, LLC,
a California limited liability company dba
LENNAR/BVHP PARTNERS

By: Lennar Southland I, Inc.,
a California corporation,
its managing member
By: Lawrance Florin
Lawrance Florin
Its: Lawrance Florin

STATE OF CALIFORNIA }
 } ss.
COUNTY OF SAN FRANCISCO }

On December 3, 2004, before me, Alma D. Basurto, Notary Public, personally appeared Marcia Rosen, personally known to me (~~or proved to me on the basis of satisfactory evidence~~) to be the person(s) whose name(s) ~~is/are~~ subscribed to the within instrument and acknowledged to me that ~~he/she/they~~ executed the same in ~~his/her/their~~ authorized capacity(ies), and that by ~~his/her/their~~ signature(s) on the instrument the person(s), or the entity upon behalf of which the person(s) acted, executed the instrument.

WITNESS my hand and official seal

Signature

Alma D. Basurto

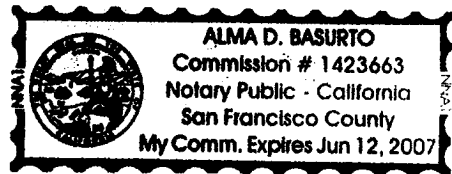

OPTIONAL

Description of Attached Document: Memorandum of Interim Lease
HPSY

Title or Type of Document: _____

Document Date: December 3, 2004 Number of Pages: _____

Signer(s) Other Than Named Above: _____

Capacity(ies) Claimed by Signer(s)

Signer's Name: Marcia Rosen

Signer's Name: _____

Title: Executive Director

Title: _____

Signer is Representing:

Right Thumb
Print

San Francisco

Signer Is Representing:

Right Thumb
Print

Redevelopment Agency

CALIFORNIA ALL-PURPOSE ACKNOWLEDGMENT

State of California }
County of San Francisco } ss.

On December 3, 2004 before me, Alma D. Basurto,
Date Name and Title of Officer (e.g., "Jane Doe, Notary Public")

personally appeared Lawrance Florin,
Name(s) of Signer(s)

- personally known to me
- proved to me on the basis of satisfactory evidence

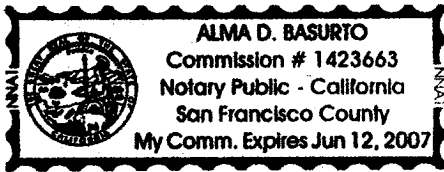

to be the person(s) whose name(s) is/are subscribed to the within instrument and acknowledged to me that he/she/they executed the same in his/her/their authorized capacity(ies), and that by his/her/their signature(s) on the instrument the person(s), or the entity upon behalf of which the person(s) acted, executed the instrument.

WITNESS my hand and official seal.

Alma D. Basurto
Signature of Notary Public

OPTIONAL

Though the information below is not required by law, it may prove valuable to persons relying on the document and could prevent fraudulent removal and reattachment of this form to another document.

Description of Attached Document

Title or Type of Document: _____

Document Date: _____ Number of Pages: _____

Signer(s) Other Than Named Above: _____

Capacity(ies) Claimed by Signer

Signer's Name: _____

- Individual
- Corporate Officer — Title(s): _____
- Partner — Limited General
- Attorney-in-Fact
- Trustee
- Guardian or Conservator
- Other: _____

Signer Is Representing: _____

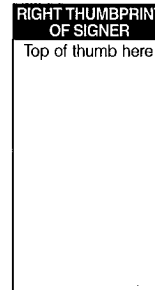

ATTACHMENT 29

EXHIBITS A-1 THRU A-4

[TO BE ADDED]

EXHIBIT A-1
Description of Premises

HUNTERS POINT SHIPYARD DEVELOPMENT PROJECT

PARCEL A-1:

ALL THAT CERTAIN REAL PROPERTY SITUATE IN THE CITY AND COUNTY OF SAN FRANCISCO, STATE OF CALIFORNIA, BEING A PORTION OF THE LANDS OF THE UNITED STATES OF AMERICA, KNOWN AS HUNTER'S POINT NAVAL RESERVATION, DESCRIBED AS FOLLOWS:

BEGINNING AT THE INTERSECTION OF THE CENTERLINE OF EARL STREET (64.00 FEET WIDE) WITH THE CENTERLINE OF INNES AVENUE (80.00 FEET WIDE); THENCE SOUTH 53°18'15" EAST ALONG THE CENTERLINE OF SAID INNES AVENUE, A DISTANCE OF 32.000 FEET TO THE SOUTHEASTERLY LINE OF SAID EARL STREET; THENCE NORTH 36°41'45" EAST ALONG THE SOUTHEASTERLY LINE OF SAID EARL STREET, A DISTANCE OF 71.239 FEET; THENCE SOUTH 53°18'15" EAST 74.153 FEET; THENCE NORTH 41°19'00" EAST 33.000 FEET; THENCE SOUTH 52°29'00" EAST 73.500 FEET; THENCE NORTH 33°53'00" EAST 24.000 FEET; THENCE SOUTH 52°33'00" EAST 43.500 FEET; THENCE NORTH 36°53'00" EAST 172.000 FEET; THENCE SOUTH 54°43'24" EAST 168.478 FEET; THENCE SOUTH 89°00'36" EAST 293.574 FEET TO THE NORTHWESTERLY LINE OF DONAHUE STREET (80.00 FEET WIDE); THENCE NORTH 36°41'45" EAST ALONG THE NORTHWESTERLY LINE OF SAID DONAHUE STREET, A DISTANCE OF 113.081 FEET TO A LINE PARALLEL WITH AND DISTANT SOUTHWESTERLY 12.933 FEET MEASURED AT RIGHT ANGLES TO THE NORTHEASTERLY LINE OF GALVEZ AVENUE (80.00 FEET WIDE); THENCE SOUTH 53°18'15" EAST ALONG SAID PARALLEL LINE, A DISTANCE OF 881.949 FEET TO A LINE PARALLEL WITH AND DISTANT SOUTHERLY 14.884 FEET MEASURED AT A RIGHT ANGLE TO THE NORTHERLY LINE OF HUNTERS POINT BOULEVARD (80.00 FEET WIDE), SAID HUNTERS POINT BOULEVARD IS SHOWN ON A MAP ENTITLED "HUNTER POINT BOULEVARD BETWEEN FAIRFAX AND GALVEZ" FILED IN BOOK M OF MAPS AT PAGE 90 ON FEBRUARY 14, 1934 IN THE OFFICE OF THE RECORDER OF THE CITY AND COUNTY OF SAN FRANCISCO; THENCE SOUTH 86°23'35" EAST ALONG SAID PARALLEL LINE 360.956 FEET; THENCE SOUTH 53°54'45" EAST 424.368 FEET; THENCE SOUTH 36°30'14" WEST 576.707 FEET; THENCE SOUTH 37°06'33" WEST 266.466 FEET; THENCE SOUTH 50°44'56" WEST 44.324 FEET; THENCE SOUTH 69°51'12" WEST 57.632 FEET; THENCE SOUTH 39°22'27" WEST 58.428 FEET; THENCE SOUTH 74°49'44" WEST 260.605 FEET; THENCE NORTH 45°32'15" WEST 292.100 FEET;

EXHIBIT A-1
Description of Premises

THENCE NORTH 53°48'15" WEST 65.565 FEET; THENCE NORTH 80°13'45" WEST 58.776 FEET; THENCE SOUTH 76°37'38" WEST 381.655 FEET; THENCE SOUTH 01°37'07" EAST 7.611 FEET; THENCE SOUTH 74°50'42" WEST 288.820 FEET; THENCE SOUTH 15°15'46" EAST 280.494 FEET; THENCE SOUTH 74°44'14" WEST 115.196 FEET; THENCE NORTH 64°12'29" WEST 648.287 FEET TO THE MOST SOUTHERLY CORNER OF THE LAND DESCRIBED IN THAT CERTAIN QUITCLAIM DEED FROM THE UNITED STATES OF AMERICA TO CRISP BUILDING, INC. FILED DECEMBER 24, 1984 IN THE OFFICE OF THE RECORDER OF SAID COUNTY, IN BOOK D767 OF OFFICIAL RECORDS, AT PAGE 1051 AS INSTRUMENT NUMBER D590252; THENCE RUNNING ALONG THE SOUTHEASTERLY LINE OF SAID LAND NORTH 25°47'31" EAST 174.841 FEET TO A LINE DRAWN PARALLEL WITH AND DISTANT NORTHWESTERLY 7.000 FEET MEASURED AT A RIGHT ANGLE TO THE SOUTHEASTERLY LINE OF DONAHUE STREET (64.00 FEET WIDE); THENCE CONTINUING ALONG THE SOUTHEASTERLY LINE OF SAID LAND AND ALONG SAID PARALLEL LINE SO DRAWN NORTH 36°41'45" EAST 17.120 FEET TO THE MOST EASTERLY CORNER OF SAID LAND, LAST SAID CORNER ALSO BEING THE MOST SOUTHERLY CORNER OF THE LAND DESCRIBED IN THAT CERTAIN QUITCLAIM DEED FROM THE UNITED STATES OF AMERICA TO THE REDEVELOPMENT AGENCY OF THE CITY AND COUNTY OF SAN FRANCISCO FILED OCTOBER 9, 1980 IN THE OFFICE OF THE RECORDER OF SAID COUNTY, IN BOOK D078 OF OFFICIAL RECORDS, AT PAGE 861 AS INSTRUMENT NUMBER D017868; THENCE RUNNING ALONG THE SOUTHEASTERLY LINE OF LAST SAID LAND AND CONTINUING ALONG LAST SAID PARALLEL LINE NORTH 36°41'45" EAST 873.000 FEET TO A LINE DRAWN PARALLEL WITH AND DISTANT SOUTHWESTERLY 7.000 FEET MEASURED AT A RIGHT ANGLE TO THE NORTHEASTERLY LINE OF JERROLD AVENUE (80.00 FEET WIDE); THENCE ALONG LAST SAID PARALLEL LINE SO DRAWN AND LAST SAID LAND NORTH 53°18'15" WEST 48.000 FEET TO A LINE DRAWN PARALLEL WITH AND DISTANT SOUTHEASTERLY 9.000 FEET MEASURED AT A RIGHT ANGLE TO THE NORTHWESTERLY LINE OF DONAHUE STREET (64.00 FEET WIDE); THENCE ALONG LAST SAID PARALLEL LINE SO DRAWN AND LAST SAID LAND NORTH 36°41'45" EAST 207.000 FEET TO THE MOST EASTERLY CORNER OF LAST SAID LAND, LAST SAID CORNER BEING ON THE SOUTHWESTERLY LINE OF INNES AVENUE (80.00' WIDE); THENCE RUNNING ALONG THE NORTHEASTERLY LINE OF LAST SAID LAND AND ALONG SAID SOUTHWESTERLY LINE OF INNES AVENUE NORTH 53°18'15" WEST 641.000 FEET TO THE MOST NORTHERLY CORNER OF LAST SAID LAND, LAST SAID CORNER ALSO BEING ON THE CENTERLINE OF EARL STREET (64.00 FEET

EXHIBIT A-1
Description of Premises

WIDE); THENCE ALONG SAID CENTERLINE OF EARL STREET NORTH 36°41'45" EAST 40.00 FEET TO THE POINT OF BEGINNING.

BEING THAT CERTAIN PROPERTY SHOWN AS "PARCEL A-1" ON THAT CERTAIN RECORD OF SURVEY, FILED OCTOBER 29, 2004 IN THE OFFICE OF THE RECORDER OF SAID COUNTY, IN BOOK AA OF MAPS, AT PAGES 170 TO 174 INCLUSIVE.

SAID PARCEL BEING PORTIONS OF BLOCKS, STREETS AND AVENUES AS SHOWN ON THAT CERTAIN MAP ENTITLED "MAP OF SOUTH SAN FRANCISCO HOMESTEAD AND RAILROAD ASSOCIATION" FILED IN THE OFFICE OF THE RECORDER OF THE CITY AND COUNTY OF SAN FRANCISCO, STATE OF CALIFORNIA ON APRIL 15, 1867 IN BOOKS 2A AND B OF MAPS, AT PAGE 39, AND PORTIONS OF BLOCKS, STREETS AND AVENUES AS SHOWN ON THAT CERTAIN MAP OF THE SURVEY PROVIDED FOR IN SECTION FOUR (4) OF AN ACT OF THE LEGISLATURE OF THE STATE OF CALIFORNIA, APPROVED MARCH 30TH, 1868, ENTITLED "A MAP OF THE SALT MARSH AND TIDE LANDS AND LANDS LYING UNDER WATER SOUTH OF SECOND STREET AND SITUATE IN THE CITY AND COUNTY OF SAN FRANCISCO", WHICH MAP IS ON FILE IN THE OFFICE OF THE STATE SURVEYOR, DULY CERTIFIED BY THE BOARD OF TIDE LAND COMMISSIONERS, AND APPROVED BY SEVERAL MEMBERS OF THE "STATE BOARD" NAMED IN SAID ACT, A DUPLICATE MAP OF SAID SURVEY BEING RETAINED AND FILED BY SAID COMMISSIONERS IN THEIR OFFICES AT SAN FRANCISCO.

A DUPLICATE MAP OF THE SURVEY IS ALSO FILED IN MAP BOOK W, PAGES 46 AND 47, IN THE OFFICE OF THE RECORDER OF THE CITY AND COUNTY OF SAN FRANCISCO.

CONTAINING 55.95 ACRES, MORE OR LESS.

BEING A PORTION OF LOT 10, ASSESSOR'S BLOCK 4591-A.

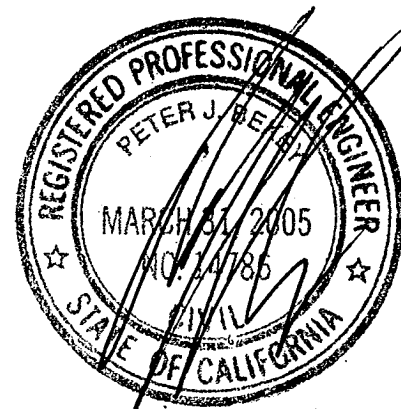
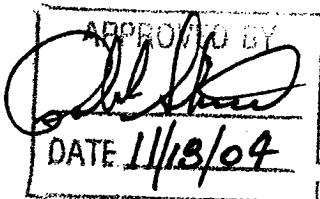

11-17/04

EXHIBIT A-1
Description of Premises

HUNTERS POINT SHIPYARD DEVELOPMENT PROJECT

PARCEL A-2:

ALL THAT CERTAIN REAL PROPERTY SITUATE IN THE CITY AND COUNTY OF SAN FRANCISCO, STATE OF CALIFORNIA, BEING A PORTION OF THE LANDS OF THE UNITED STATES OF AMERICA, KNOWN AS HUNTER'S POINT NAVAL RESERVATION, DESCRIBED AS FOLLOWS:

BEGINNING AT THE INTERSECTION OF THE CENTERLINE OF GRIFFITH STREET (64.00 FEET WIDE) WITH THE CENTERLINE OF McKINNON AVENUE (80.00 FEET WIDE); THENCE ALONG SAID CENTERLINE OF McKINNON AVENUE SOUTH 53°18'15" EAST 663.962 FEET TO THE CENTERLINE OF FITCH STREET (64.00 FEET WIDE); THENCE ALONG SAID CENTERLINE OF FITCH STREET NORTH 36°41'45" EAST 319.260 FEET TO A POINT ON A LINE DRAWN PARALLEL WITH AND DISTANT SOUTHWESTERLY 0.77 FEET, MEASURED AT A RIGHT ANGLE, FROM THE NORTHEASTERLY LINE OF LA SALLE AVENUE (80.00 FEET WIDE), SAID POINT BEING THE MOST WESTERLY CORNER OF THE LAND DESCRIBED IN THAT CERTAIN QUITCLAIM DEED FROM THE UNITED STATES OF AMERICA TO THE SAN FRANCISCO HOUSING AUTHORITY FILED OCTOBER 26, 1977 IN THE OFFICE OF THE RECORDER OF SAID COUNTY, IN BOOK C459 OF OFFICIAL RECORDS, AT PAGE 672 AS INSTRUMENT NUMBER A038827; THENCE ALONG SAID PARALLEL LINE SO DRAWN, AND THE SOUTHWESTERLY LINE OF SAID LAND, SOUTH 53°18'15" EAST 626.660 FEET TO THE MOST SOUTHERLY CORNER OF SAID LAND, LAST SAID CORNER BEING ON THE NORTHWESTERLY LINE OF THE LAND DESCRIBED IN THAT CERTAIN QUITCLAIM DEED FROM THE UNITED STATES OF AMERICA TO THE REDEVELOPMENT AGENCY OF THE CITY AND COUNTY OF SAN FRANCISCO FILED OCTOBER 9, 1980 IN THE OFFICE OF THE RECORDER OF SAID COUNTY, IN BOOK D078 OF OFFICIAL RECORDS, AT PAGE 861 AS INSTRUMENT NUMBER D017868; THENCE ALONG SAID NORTHWESTERLY LINE OF LAST SAID LAND THE FOLLOWING FIVE COURSES, SOUTH 53°18'15" EAST 5.301 FEET TO THE BEGINNING OF A NON-TANGENT CURVE CONCAVE NORTHWESTERLY, HAVING A RADIUS OF 105.000 FEET (A RADIAL LINE TO THE BEGINNING OF SAID CURVE BEARS SOUTH 53°15'52" EAST); THENCE SOUTHWESTERLY 69.170 FEET ALONG SAID CURVE, THROUGH A

EXHIBIT A-1
Description of Premises

CENTRAL ANGLE OF 37°44'39"; THENCE ALONG A RADIAL LINE TO THE TERMINUS OF SAID CURVE SOUTH 15°31'13" EAST 50.000 FEET TO THE BEGINNING OF A NON-TANGENT CURVE CONCAVE SOUTHERLY, HAVING A RADIUS OF 20.000 FEET (A RADIAL LINE TO THE BEGINNING OF LAST SAID CURVE BEARS NORTH 15°31'13" WEST); THENCE EASTERLY AND SOUTHEASTERLY 16.919 FEET ALONG LAST SAID CURVE THROUGH A CENTRAL ANGLE OF 48°28'07", A RADIAL TO LAST SAID POINT BEARS SOUTH 32°56'54" WEST; THENCE SOUTH 36°41'45" WEST 231.95 FEET TO THE MOST WESTERLY CORNER OF LAST SAID LAND, LAST SAID CORNER ALSO BEING THE MOST NORTHERLY CORNER OF THE LAND DESCRIBED IN THAT CERTAIN QUITCLAIM DEED FROM THE UNITED STATES OF AMERICA TO CRISP BUILDING, INC. FILED DECEMBER 24, 1984 IN THE OFFICE OF THE RECORDER OF SAID COUNTY, IN BOOK D767 OF OFFICIAL RECORDS, AT PAGE 1051 AS INSTRUMENT NUMBER D590252; THENCE RUNNING ALONG THE NORTHWESTERLY LINE OF LAST SAID LAND THE FOLLOWING THREE COURSES, SOUTH 36°41'45" WEST 167.000 FEET; THENCE NORTH 64°12'29" WEST 22.160 FEET; THENCE SOUTH 25°47'31" WEST 158.000 FEET TO THE MOST WESTERLY CORNER OF LAST SAID LAND; THENCE NORTH 64°12'29" WEST 672.578 FEET; THENCE NORTH 70°21'24" WEST 156.810 FEET; THENCE NORTH 71°30'32" WEST 146.250 FEET ; THENCE NORTH 79°19'32" WEST 394.790 FEET TO THE SOUTHEASTERLY LINE OF GRIFFITH STREET (64.00 FEET WIDE); THENCE ALONG SAID SOUTHEASTERLY LINE OF GRIFFITH STREET NORTH 36°41'45" EAST 118.257 FEET TO THE SOUTHWESTERLY LINE OF OAKDALE AVENUE (80.00 FEET WIDE); THENCE ALONG SAID SOUTHWESTERLY LINE OF OAKDALE AVENUE NORTH 53°18'15" WEST 32.000 FEET TO SAID CENTERLINE OF GRIFFITH STREET; THENCE ALONG SAID CENTERLINE OF GRIFFITH STREET NORTH 36°41'45" EAST 600.060 FEET TO SAID CENTERLINE OF MCKINNON AVENUE AND THE POINT OF BEGINNING.

BEING THAT CERTAIN PROPERTY IS SHOWN AS "PARCEL A-2" ON THAT CERTAIN RECORD OF SURVEY FILED OCTOBER 29, 2004 IN THE OFFICE OF THE RECORDER OF SAID COUNTY, IN BOOK AA OF MAPS, AT PAGES 170 TO 174 INCLUSIVE.

EXHIBIT A-1
Description of Premises

SAID PARCEL BEING PORTIONS OF BLOCKS, STREETS AND AVENUES AS SHOWN ON THAT CERTAIN MAP ENTITLED "MAP OF SOUTH SAN FRANCISCO HOMESTEAD AND RAILROAD ASSOCIATION" FILED IN THE OFFICE OF THE RECORDER OF THE CITY AND COUNTY OF SAN FRANCISCO, STATE OF CALIFORNIA ON APRIL 15, 1867 IN BOOKS 2A AND B OF MAPS, AT PAGE 39; AND PORTIONS OF BLOCKS, STREETS AND AVENUES AS SHOWN ON THAT CERTAIN MAP ENTITLED "HUNTER TRACT" FILED IN THE OFFICE OF THE RECORDER OF THE CITY AND COUNTY OF SAN FRANCISCO, STATE OF CALIFORNIA ON MAY 24, 1871, IN BOOK 1 OF MAPS, AT PAGE 144; AND PORTIONS OF BLOCKS, STREETS AND AVENUES AS SHOWN ON THAT CERTAIN MAP OF THE SURVEY PROVIDED FOR IN SECTION FOUR (4) OF AN ACT OF THE LEGISLATURE OF THE STATE OF CALIFORNIA, APPROVED MARCH 30TH, 1868, ENTITLED "A MAP OF THE SALT MARSH AND TIDE LANDS AND LANDS LYING UNDER WATER SOUTH OF SECOND STREET AND SITUATE IN THE CITY AND COUNTY OF SAN FRANCISCO", WHICH MAP IS ON FILE IN THE OFFICE OF THE STATE SURVEYOR, DULY CERTIFIED BY THE BOARD OF TIDE LAND COMMISSIONERS, AND APPROVED BY SEVERAL MEMBERS OF THE "STATE BOARD" NAMED IN SAID ACT, A DUPLICATE MAP OF SAID SURVEY BEING RETAINED AND FILED BY SAID COMMISSIONERS IN THEIR OFFICES AT SAN FRANCISCO.

A DUPLICATE MAP OF THE SURVEY IS ALSO FILED IN MAP BOOK W, PAGES 46 AND 47, IN THE OFFICE OF THE RECORDER OF THE CITY AND COUNTY OF SAN FRANCISCO.

CONTAINING 19.502 ACRES, MORE OR LESS.

BEING A PORTION OF LOT 10, ASSESSOR'S BLOCK 4591-A.

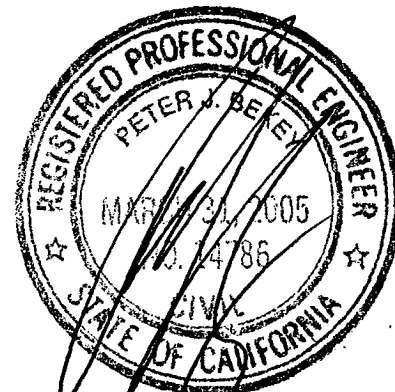
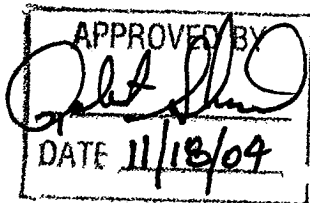
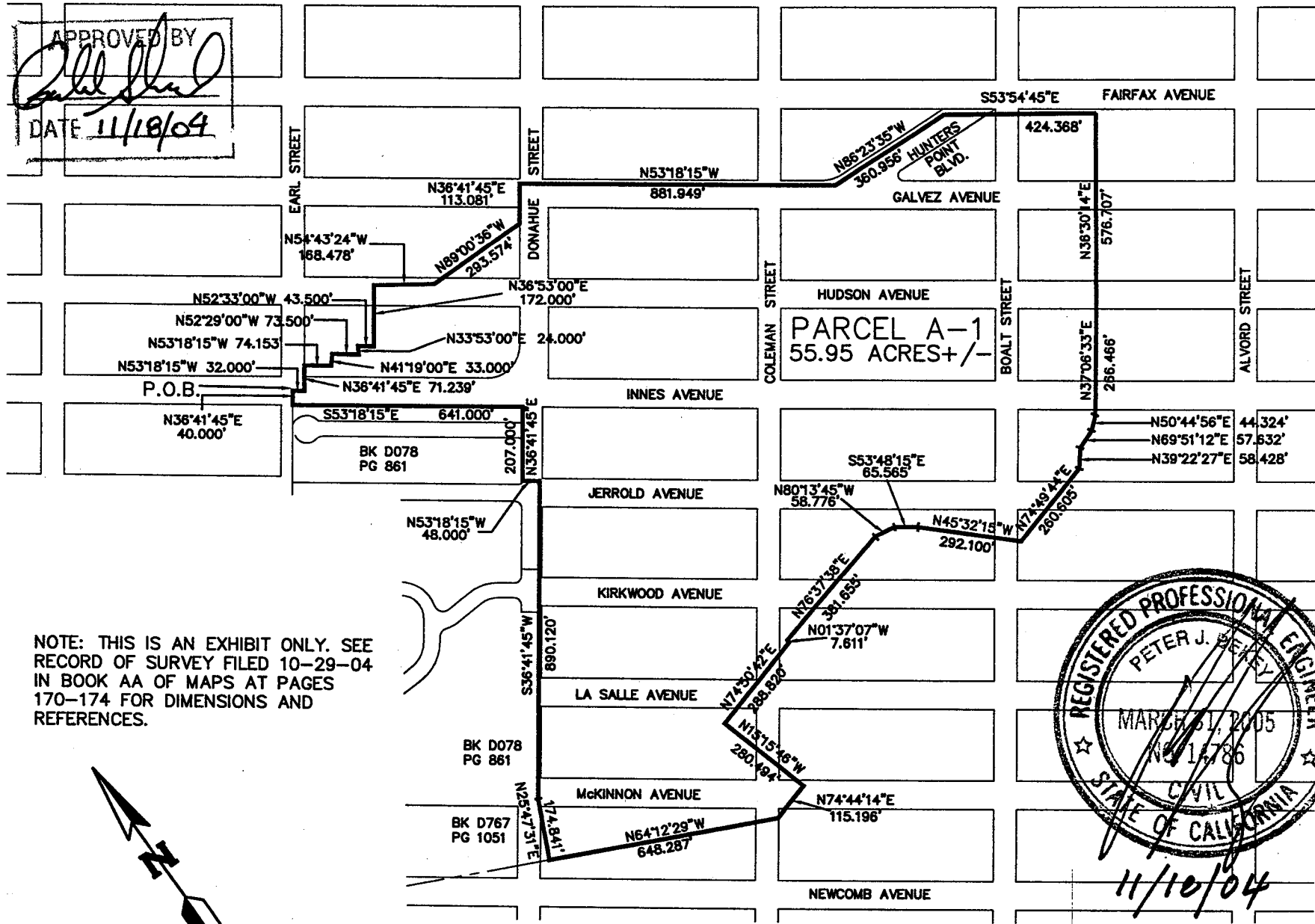

EXHIBIT B

[TO BE ADDED: DESCRIPTION OF STATE LANDS PARCEL]

APPROVED BY
[Signature]
 DATE 11/18/04



NOTE: THIS IS AN EXHIBIT ONLY. SEE RECORD OF SURVEY FILED 10-29-04 IN BOOK AA OF MAPS AT PAGES 170-174 FOR DIMENSIONS AND REFERENCES.

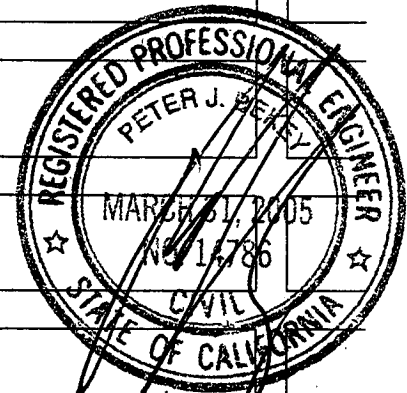
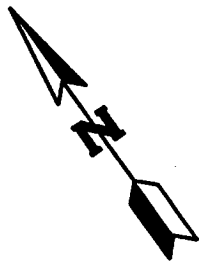

11/10/04

EXHIBIT A-2
 Map of Premises

CONVEYANCE PARCEL A-1
 HUNTERS POINT SHIPYARD

EXHIBIT PREPARED BY KCA ENGINEERS

EXHIBIT A-2
Map of Premises

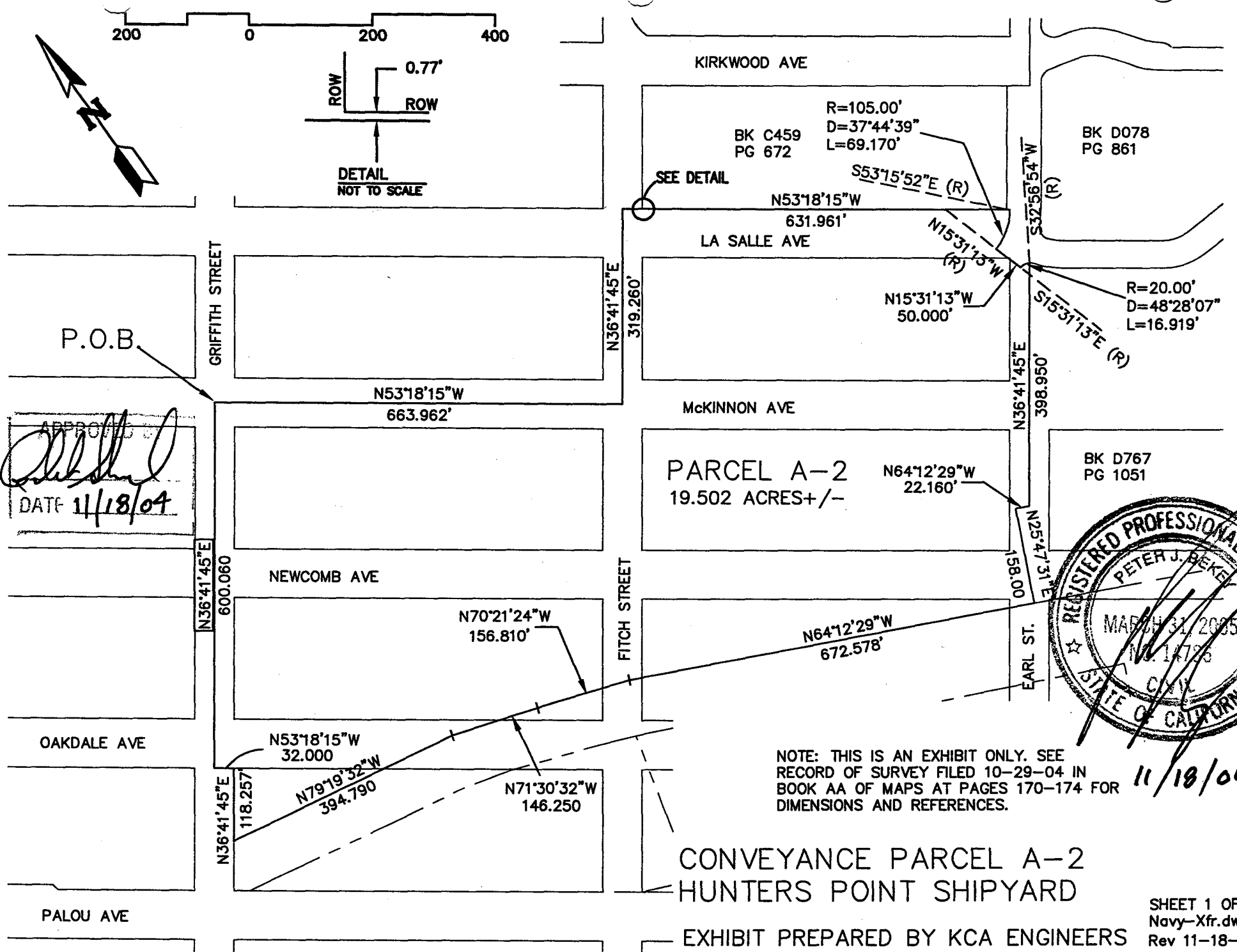
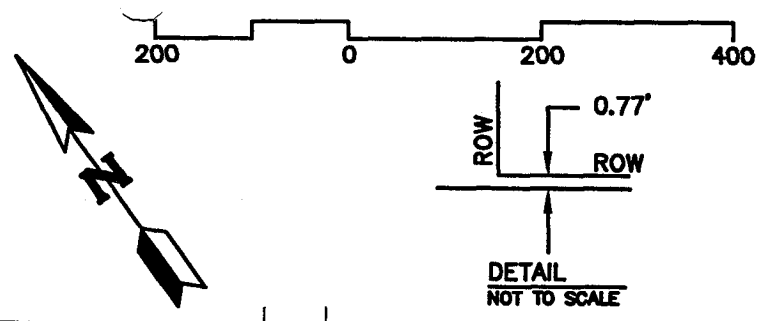

NOTE: THIS IS AN EXHIBIT ONLY. SEE RECORD OF SURVEY FILED 10-29-04 IN BOOK AA OF MAPS AT PAGES 170-174 FOR DIMENSIONS AND REFERENCES.

11/18/04

CONVEYANCE PARCEL A-2
HUNTERS POINT SHIPYARD

EXHIBIT PREPARED BY KCA ENGINEERS

Exhibit C - RESERVED

Exhibit D – Security Services

I. Objective

Tenant shall assume the responsibilities of the Caretaker by providing patrol and security services in accordance with the requirements set forth herein. The objective of the security program is to detect, deter, and report occurrences of trespass, theft, vandalism, dumping, and any other unauthorized activities occurring within the perimeters of HPS. The CSO, with mutual agreement by the Caretaker, may modify services to best meet the present and future needs of the Shipyard's tenants, users and stakeholders.

II. Authority and Jurisdiction

- a. *Authority*- Security personnel shall not perform police duties (including the power to arrest), bear arms or use deadly force. Security personnel shall only detect, deter, and report occurrences of trespass, theft, vandalism, dumping, and any other unauthorized activities occurring within the perimeters of HPS. Security personnel shall detain trespassers, report such incidents and turn over detainees to proper authorities for escort off of the premises. Security personnel shall only "observe and report" illegal activities that occur outside of the HPS boundaries to the proper authorities.
- b. *Jurisdiction*- There is concurrent jurisdiction on HPS whereby various entities have or will have authority over certain portions of the shipyard. The Caretaker shall, from time to time, provide security personnel with an up to date list of the various entities and the boundaries of each specific jurisdiction. Security personnel shall be familiar with and comply with the limits of each jurisdiction and adhere to the governing rules and regulations.
- c. *Property Boundaries* – The Caretaker shall provide the security personnel with a map of the premises and a description of the boundaries of HPS.
- d. *Reporting* – Security personnel shall report to the Caretaker regarding administrative matters, including the daily operations of the shipyard. However, security personnel shall immediately report emergencies and unauthorized activities to the appropriate authorities according to the jurisdictional boundaries specified by the Caretaker.

III. General Personnel Requirements

- a. The security contractor for HPS shall be licensed and bonded; and all security personnel shall have a valid California Drivers License and a Guard Card certified by the California State Department of Consumer Affairs. All

security personnel must undergo a background check and must be screened prior to being assigned to HPS.

- b. The Navy reserves the right to direct the removal of any security personnel for inappropriate appearance or conduct. Caretaker shall initiate immediate action to replace such an employee and to maintain continuity of services at no additional cost to the Navy.
- c. The Caretaker shall maintain satisfactory standards of employee competency, conduct, and appearance.
- d. Each employee is expected to adhere to SFPD standards.
- e. Training shall meet the requirements of OPNAVINST 5530.14.B.
- f. Caretaker shall endeavor to provide the same security personnel during the same shift and to minimize personnel changes.
- g. The Caretaker shall arrange for continuous supervisory observation and evaluation of all security personnel and take appropriate corrective measures for inappropriate behavior noted in the course of performing assigned guard services duties.

IV. Staffing and Schedules

The Caretaker shall provide the following security personnel seven (7) days per week: one (1) security officer at the main front entrance gate (Innes Avenue) twenty-four hours each day; and one (1) mobile officer continuously patrolling the interior and perimeter of HPS sixteen hours each day. Coverage for the mobile office shall consist of the swing and graveyard shifts. Security personnel shall remain on assignment until properly relieved by direction of immediate supervisor. The shift security guard shall pass all information relative to assignment to the relieving guard. At no time shall a post be left unmanned or abandoned.

Supervisor - The Caretaker shall provide adequate supervision of patrol/security employees at all times. The supervisors shall ensure that each post is manned as required. Supervisory personnel in charge of work under this section shall be available at all times to receive and implement orders or special instructions from the CSO concerning matters that affect the operation, protection and security of HPS. Supervisory personnel shall randomly visit the site and maintain radio contact with the guard on duty for potential back-up.

Main Gate – Security personnel stationed at the main gate shall control access (Innes Avenue) to the Hunters Point Shipyard area to prevent theft, trespassing and vandalism; monitor and enforce all applicable rules and regulations as provided by the Caretaker. Security personnel may be required to screen all personnel, property or vehicles entering the premises. Provide assistance and information to tenants and visitors seeking access to the Shipyard.

Rover – The roving patrol function includes both foot and motorized patrols. Patrols include outlying areas, as well as areas within the main base.

- a. Perimeter - Once every two- (2) hours, a check shall be made of the entire base perimeter to detect unauthorized entry (attempted or actual). Routes shall be varied in order not to establish a set pattern.
- b. Building/Equipment Checks- Security checks shall be made during each round of all buildings identified by Caretaker (leased facilities not included). While checks are primarily to detect unsecured facilities, the patrol shall also immediately report fire, flooding, or other condition that could result in damage to buildings/equipment or injuries to personnel. An interior security check shall be performed when the integrity of any building, structure, or facility has been compromised. A report of all incidents shall be provided to the Caretaker manager and documented in the daily log for CSO review.
- c. Gate/Building Openings- Locked gates or buildings shall be opened in response to an authorized request by the CSO. A record of all gate/building openings shall be included in the daily report log.

V. Materials and Equipment

The Caretaker shall provide all equipment and materials needed to perform the Scope of Services. The CSO may inspect equipment and material for adequacy and compliance.

- a. *Uniforms* – All security personnel shall wear well fitting, high quality uniforms suited to seasonal weather conditions (including foul weather rain gear and boots), which distinguishes them as part of an official security workforce. While on duty, all security personnel must wear rubber-soled shoes or boots at all times.

- b. *Vehicle* – The Caretaker, or its security vendor, shall provide one (1) patrol vehicle that shall be clearly marked on all sides with distinctive insignia containing the word “SECURITY”. The patrol vehicle shall be equipped with light bar, mounted searchlight and installed prisoner cage (for temporary detention purposes while waiting for the appropriate authorities). The patrol vehicle shall be kept in a safe operating condition. All fuel, oil, lubricants, and maintenance of the patrol vehicle are the sole responsibility of the Caretaker or its security vendor. Unless otherwise approved by the CSO, no fueling or maintenance shall be performed at HPS.
- c. *Communications* - The Caretaker, or its security vendor, shall provide all necessary communications equipment for communications as required by CSO. Additionally, for the term of this Agreement, the Navy will provide two hand held combination phone/radio/paging units for communication with the CSO. Phone numbers and radio unit ID numbers will be provided by the CSO. Equipment is to remain on the installation for use by security personnel 24 hours a day.

VI. Records

Security personnel shall maintain Daily Activity Reports (DAR) which document routine activities and post assignments; a Security Call Sheet which lists all patrol/security, supervisors, and manager and their contact information; Post Supervisors Log; and other such appropriate records to ensure the proper, timely, and efficient performance of requirements. Copies of each record will be provided to the CSO by 0730 on every business workday.

Security personnel shall also maintain Incident Reports (IR) which document details of unusual occurrences, trespassing, vandalism, dumping, threats, damage to property, safety hazards, maintenance issues, injuries, etc. A copy of Incident Reports shall be provided to CSO by 0730 the business workday.

VII. Scope of Services

Security personnel shall:

- a. obey all appropriate orders emanating from supervisory authorities;
- b. deter unauthorized persons and vehicles from entering HPS; ensure that any unauthorized persons and vehicles which gains access to HPS are safely escorted off of the premises. All such incidents should be promptly reported to supervisory personnel and the appropriate authorities;

- c. monitor and report incidents of damage, pilferage, removal, destruction, misuse, larceny, theft, vandalism, trash dumping or other improper or unlawful threats to, or disposition of, Navy or personal property or acts of sabotage, or wrongful destruction within the assigned areas;
- d. report the occurrence of fires, explosions, collapses, and other catastrophes. In such an event, the Caretaker shall summon appropriate response forces and then notify CSO personnel. Assist in minimizing the impacts of such occurrences and restoring the area to a safe secure condition;
- e. deter the commission of crimes against persons, summon appropriate response forces or make appropriate response, and assist response forces as required;
- f. provide proper documentation and reports of all incidents. Pass relevant information to relieving guard. Provide and maintain at each guard post sufficient copies of post orders. The CSO reserves the right to change post orders provided such change does not affect the cost of the agreement. Special Orders are short term or one-time changes;
- g. make no statements to news media or the general community regarding events or occurrences at HPS unless otherwise directed by the Caretaker or appropriate authorities. All inquiries shall be directed to the CSO;
- h. report suspected or actual medical emergencies to the 911 Operator, and take other appropriate actions such as escort emergency personnel and complete an Incident Report;
- i. assist emergency response personnel, the Caretaker, and CSO, as directed, with disaster recovery efforts in the event of a major catastrophe (acts of nature and terrorist acts) such as fires, explosions, medical emergencies, and emergency evacuations;
- j. enforce the current access and identification program for HPS by identifying all personnel, tenants, and visitors seeking access to the shipyard;
- k. assist as required in redirecting traffic, placing warning flares or traffic cones and any other safety protective actions necessary after the occurrence of a traffic accident.

VIII. Emergency Response Plan and Procedures

The Caretaker shall, in collaboration with the appropriate local and federal emergency response agencies, complete, implement, and maintain an emergency

preparedness and disaster recovery program for HPS. The Caretaker shall conduct routine disaster recovery training and drills for security personnel and ensure that each guard understands the procedures to follow in the event of a catastrophe.

EXHIBIT E – SCOPE OF SERVICES – INTERIM LEASE

General

All capitalized terms used without definition shall have the meanings set forth in the Lease. The provisions of the Lease, except where clearly inconsistent or inapplicable to this Exhibit E – Scope of Services (the "Scope of Services"), are hereby incorporated into this Scope of Services. Without limiting the generality of the foregoing, the provisions of Section 1.1(b), and Articles 5 and 6 of the Lease shall apply to all services performed hereunder.

EXHIBIT E-1 – BASELINE SERVICES

Subject to the terms and conditions of this Lease, Tenant shall provide or cause to be provided, at no cost to Agency and at Tenant's sole cost and expense, all labor, supervision, materials, supplies, equipment (including, without limitation thereto, all security and safety services), and services necessary to keep the entire Premises (both Active Premises and Passive Premises) in such condition so as to avoid the occurrence of any Loss or Losses to an Indemnified Party for which Tenant would be obligated to defend pursuant to Article 12 hereof (the "Baseline Services"). Without limiting the generality of the foregoing and particularly with respect to the Passive Premises, Baseline Services shall include, without limitation thereto, the following:

1. SITE MANAGEMENT; SITE OFFICE

- a) Tenant shall perform the following site management services or furnish the facilities therefor as follows:
- b) Maintain the Passive Premises in a secured and safe condition to deter unlawful entry.
- c) Perform any obligations imposed by the Lease relating to the Passive Premises.
- d) Obtain all necessary governmental approvals and permits necessary to comply with all Laws, rules, ordinances, statutes, and regulations applicable to the Passive Premises.
- e) Open a site office located in a publicly accessible area of the Shipyard for the administration of Tenant's responsibilities under the Lease (the "Site Office"). The Site Office shall have appropriate space, personnel and equipment to (i) respond to inquiries by subtenants and the public and (ii) provide for Agency's use a project trailer of sufficient size to accommodate an office and conference room for community meetings. The site office shall be open and staffed Monday through Friday from 8 am to 5 pm. Tenant shall also provide after hours emergency contact number.

2. SECURITY AND LIGHTING

Tenant shall implement the Fencing and Lighting Plan attached to the Lease as Exhibit G.

3. ENVIRONMENTAL MONITORING

Tenant, at its sole cost and expense, shall monitor and evaluate Hazardous Materials through an environmental monitoring program to be mutually agreed to by the Parties. Tenant or its contractors shall report to the City any incident of dust or spilled dirt related to the Navy's remediation and hauling efforts.

4. GROUNDS MAINTENANCE

Tenant shall provide landscape, grounds, and roadway maintenance, trash collection, and street cleaning services in accordance with the following responsibilities:

- a) Ground Cover/Landscape. Tenant shall implement a Weed Abatement and Fire Prevention Plan that shall be approved by the Agency prior to execution of the Interim Lease. Chemicals used for weed abatement must first be in compliance with applicable City standards.
- b) Litter Control & Trash Collection. Tenant will keep the Passive Premises clear of debris pursuant to the approved Weed Abatement and Fire Prevention Plan to protect personal safety.
- c) Pest Control. Tenant in carrying out its operations shall assume pesticides are potentially hazardous to human and environmental health and shall follow the integrated pest management ("IPM") approach in accordance with the provisions of Chapter 39 San Francisco Integrated Pest Management Program adopted by the Board of Supervisors on October, 1996. Tenant shall identify and implement an IPM plan that shall minimize the use of toxic chemical and gets rid of pests by methods that pose a lower risk to public and environmental health. Tenant shall identify and implement an IPM plan as outlined:
 - (1) Identify the pest and/or problem.
 - (2) Monitor pest ecosystem to determine pest population, size, occurrence and natural predator population, if present.
 - (3) Consider a range of potential treatments for the pest problem and select control strategies that may be implemented effectively and in a manner that is long-lasting and the least disruptive effect on the environment.
 - (4) Employ non-pesticide management tactics first. Consider the use of chemicals only as a last resort and select and use chemicals only within an IPM Program.
 - (5) Determine the most effective treatment time, based on pest biology and other variables, such as weather, seasonal changes in wildlife use and local conditions.

- (6) Monitor treatment to evaluate effectiveness and continue monitoring records for inclusion in the IPM implementation plan.

5. STREET MAINTENANCE

Tenant shall comply with the following Street Maintenance Standards for Innes, Donahue, Galvez, Robinson, Fisher, Spear and Crisp Streets and for any other streets necessary to provide safe ingress and egress to Active Premises:

- a) Street Maintenance Standards
 - i) Repair lifted, separated, cracked or other damaged paving that presents a potential or actual public safety hazard.
 - ii) Provide appropriate street striping and signage to be mutually agreed upon by Agency and Tenant.
 - iii) Sweep streets as needed based on experience with observed need and to maintain safe access, subject to the reporting obligation set forth in Section 3 hereof (regarding "Environmental Monitoring").
 - iv) For those streets within the Navy property, Tenant shall comply with all applicable requirements of the Access Easement for Roads, dated December 3, 2004, by and between the United States of America, acting by and through the Department of the Navy and the San Francisco Redevelopment Agency.

6. BASELINE UTILITY SERVICES

This utilities services section describes the level of operation and maintenance services ("O&M") relating to certain water, sanitary and storm sewer utility systems by Tenant within the Premises at Hunters Point Shipyard ("Shipyard"). The existing electrical and natural gas supply and distribution systems at The Shipyard are owned and operated by Pacific Gas and Electric ("PG&E"). The intent of this section, in part, is to ensure that the obligations of Agency under the Navy Utilities Agreement will be carried out by Tenant with respect to the entire Premises. If any provision of this Lease conflicts with the Navy Utilities Agreement such that Tenant cannot satisfy both its obligations under this Lease and perform the Agency obligations under the Navy Utilities Agreement, the Navy Utilities Agreement shall prevail.

- a) General. Tenant shall provide to the entire Premises (i.e., in both the Active and Passive Premises) the O&M at the Shipyard, including, without limitation thereto:
 - i) Operate and maintain the existing water distribution, sanitary sewer, and storm water collection systems on the Premises, as feasible;
 - ii) Repair as needed any facilities within the Premises to continue utility service, as feasible;

- iii) In the event that existing utility services cannot feasibly be used or repaired, the Tenant shall coordinate with the Agency and sub-Tenants to determine the most appropriate method of providing essential utility services;
- iv) Install new facilities to keep essential services operational in accordance with (iii);
- v) Coordinate operations, maintenance, and repair of electrical distribution, gas distribution, and telephone systems provided to the tenants by third party providers;
- vi) Respond to and report Trouble Calls (as described below), all in accordance with accepted industry standards that are protective of human health, the environment, and Premises;
- vii) Coordinate with Pacific Gas & Electric Company, or the successor or Affiliate thereof ("PG&E") for PG&E to continue to provide services at the Shipyard during the term of the Lease;
- viii) Coordinate with appropriate telecommunication companies to continue to provide services on the Premises during the term of the Lease

(hereinafter collectively referred to as the "Baseline Utility Services").

b) Systems Definitions, Extent of Caretaker Responsibility for Utilities Distribution. The physical extent of each utility system that will be operated and maintained by Tenant is described below. The descriptions apply to all elements of systems located on the Premises. Tenant will establish responsibilities within shared boundaries with the Navy through the Agency.

- i) Water System: Tenant shall repair, operate, and maintain the components of the Water Distribution Pipelines (as hereinafter described) on the Premises and extend such services as needed to service the Active Premises in such a manner that protects human health and the environment, provided that Tenant shall have no obligation to extend, repair, operate or maintain the water system to Building 808.
- ii) Sanitary Sewer Facilities: Tenant shall repair, operate, and maintain the components of the sanitary sewer service on the Premises that are needed to service Active Premises in such a manner that protects human health and the environment. Within four (4) months of the Effective Date of the Lease, Tenant shall disconnect the Premises from the Navy sanitary sewer system and determine the appropriate method of providing, and shall establish, an alternative sewer service to the Active Premises in accordance with the Utilities Agreement dated December 3, 2004, between the United States of America, acting by and through the Navy and the San Francisco Redevelopment Agency ("Navy Utilities

) Agreement"). The portable restroom facilities being provided to Building 808 are an alternative sewer system with respect to that portion of the Premises and shall be provided to the extent required by law.

- iii) Storm Water System: Tenant shall repair, operate, and maintain the existing storm water system located on the Premises which crosses through Passive Premises and that are needed to service Active Premises in a manner that protects human health and the environment. Tenant shall manage storm water in accordance with the Navy Utilities Agreement and all applicable federal, state and local laws. In addition, in accordance with the Navy Utilities Agreement, Tenant shall monitor storm water at the storm water monitoring points set forth in the Navy Utilities Agreement in accordance with the storm water monitoring requirements of the Navy Utilities Agreement. Tenant shall deliver storm water on the Premises to the Storm Water Outlet Points identified in the Navy Utilities Agreement. Tenant shall otherwise comply with all requirements set forth in the Navy Utilities Agreement for the management of storm water.
- iv) Natural Gas System. Natural gas is delivered to the Shipyard by a supply line owned by PG&E. PG&E also owns and operates the main meters and pressure reducing stations at the point of delivery and the lines to individual tenants. Tenant shall coordinate with PG&E to assure that PG&E continues to provide services during the Term of the Lease and interim construction period.
- v) Electrical Distribution System: PG&E owns the electrical distribution system at The Shipyard, which consists of a 12-kv distribution line, pole transformers, and secondary distribution lines to facilities. The responsibility of Tenant is to coordinate with PG&E for PG&E to continue service to Active Premises.
- vi) Telephone System. Tenant shall disconnect the Navy-owned telecommunication system that is now located at Building 813 within six (6) months of the effective date of the Navy Utilities Agreement, in accordance with the Navy Utilities Agreement. Tenant shall assure that telecommunication providers provide services to Active Premises during the Term of the Lease.

)

c) Capital Improvements and Performance Standards

- i) Water System Improvements and Usage. Tenant shall account for and pay for the water usage of all subtenants and other uses on the Premises. Tenant shall investigate the source of each subtenant's usage of water and determine the appropriate place(s) to meter their respective use. For Passive Premises contemplated for occupancy, Tenant shall use the same guidelines above prior to installing a water meter and back flow preventer.
-)

1. Tenant understands and acknowledges that SFWD extended an existing water line along Innes Avenue to the boundary of the Hunters Point Shipyard at Earl Street. When an extension of this water system into the Premises is desired, Tenant shall pay the SFWD for the installation of the appropriate sized and configured water meter and back flow preventer needed to serve its needs and/or relocate such water system improvements already installed.
 2. Tenant understands and acknowledges that the Navy has isolated the Premises from the remainder of the Hunters Point Shipyard. Tenant shall assure that water service is provided to all Active Premises, except Building 808 (unless provision of such water service is required by law), during the Term of the Lease.
 3. "Other Uses" of water such as irrigation, water system flushing, fugitive dust mitigation, or other non-building uses shall be metered through a portable device.
- ii) Storm Water System Improvements. Tenant shall construct an extension of the storm drain line through Parcel B into Government Outfall 1 (as defined in the Navy Utilities Agreement) in accordance with and according to the schedule set forth in the Navy Utilities Agreement for construction of the Donohue Street Alignment (as defined in the Navy Utilities Agreement). The Parties agree that it is desirable to provide for a storm water system separate from the Navy system. Therefore, Tenant shall construct, if feasible, a storm water connection to the sewer system within the Crisp Alignment (as defined in the Navy Utilities Agreement), as provided for in the Navy Utilities Agreement, to provide for any storm waters from Parcel A-2 to discharge into the City sewer system, to the extent they do not do so already. Further, Tenant shall construct, if feasible, a storm water connection within the Crisp-Spear-Blandy Alignment (as defined in the Navy Utilities Agreement) as provided for by the Navy Utilities Agreement to allow storm water from the Premises to flow to a Government Outfall north of Drydock No. 4, to the extent the storm water from Parcel A-1 is not otherwise managed through the Donohue Street Alignment.
- iii) Natural Gas Improvements. The Parties shall not be obligated to one another for any capital improvements to the Natural Gas System.
- iv) Electrical Distribution Improvements. No capital improvements are contemplated.
- d) Organization and Communication. All essential communications regarding utility operations between the Tenant and the Navy shall be shared with the Agency. Notification of planned outages or any other pertinent utilities information shall be made in advance by the Tenant to sub-Tenants, the Navy and the Agency.

- e) Preventative Maintenance & Repair Work. Regularly scheduled preventive maintenance and all non-emergency repair work will be executed as determined necessary by Tenant.
- f) Trouble Call Response and Reporting. Tenant shall be responsive to trouble calls regarding breakdowns or cessation of service ("Trouble Calls. Tenant shall provide to Agency an up to date list of telephone numbers for primary personnel responsible for utilities operations at the Premises ("Tenant Contact List"). Tenant Contact List will be used when contact cannot be made with the Tenant's trouble reception desk; in cases of emergency; and in cases in which responses to trouble calls do not occur within a reasonable time and trouble calls are received by the Agency.
- g) Emergency Response
 - i) Trouble calls to Tenant will be designated as an EMERGENCY when it has been determined or is suspected that immediate action is required to eliminate a threat to human health, the environment, to protect property or to avoid disruption of essential operations. Situations satisfying these criteria may also be observed directly by Tenant personnel or may be reported to Tenant by means other than the normal trouble reception protocol described here.
 - ii) Reporting. Tenant shall notify the Agency immediately of any "Significant Event" (major personal injury or death, major property damage, including, without limitation thereto, "large" fires) that has occurred.

EXHIBIT E-2 – ACTIVE SERVICES TO SUBLEASED OR OCCUPIED PREMISES

Subject to the terms and conditions of this Lease, Tenant shall provide, at no cost to Agency and at Tenant's sole cost and expense and in addition to the Baseline Services (as herein above defined) to be performed by Tenant, all labor, supervision, materials, supplies, and equipment necessary for the repair and maintenance of the Active Premises, including but not limited to the grounds, facilities, equipment and any utility infrastructure directly serving, and situated within, the Active Premises and whether structural or non-structural, interior or exterior, ordinary or extraordinary, foreseen or unforeseen.

Without limiting the generality of the foregoing, Active Services shall include, without limitation thereto, the following:

1. SITE MANAGEMENT AND LEASING

(a) General responsibilities.

- (i) Tenant shall keep the Active Premises in good order and in a clean, and safe condition. Tenant shall be responsible for maintaining the Active Premises in the condition existing at the commencement of this Lease, reasonable wear and tear excepted (as determined by Agency).
- (ii) Take all actions consistent with this Interim Lease and in accordance with prudent business practice for the profitable operation of the Premises.
- (iii) To perform any obligations imposed by subleases or other leases relevant to the Premises.
- (iv) To enforce the terms of the subleases.
- (v) To hire, direct, employ and dismiss independent contractors and employees necessary for the maintenance and operation of the Premises. To pay all wages and other employment charges such as Social Security, workmen's compensation insurance, unemployment insurance, and taxes in accordance with the Agency's policies including, without limitation, the Agency's policies on Minimum Compensation and Health Care.
- (vi) To purchase all supplies, equipment, materials, and services for the operation of the Premises consistent within the limits imposed by this Interim Lease.
- (vii) To make all repairs and capital improvements necessary to keep the Premises in good repair within the requirements imposed by this Lease (including, without limitation thereto, Section 1(a)(i)).
- (viii) To collect all tenant rent payments due under the subleases and any other income from the Active Premises.

- (ix) To renew, expand, and reduce subleases as necessary.
- (x) To obtain all necessary governmental approvals and permits necessary to comply with all laws, rules, ordinances, statutes, and regulations applicable to the Active Premises including, without limitation, Building Code compliance.

2. ENVIRONMENTAL MONITORING

- (a) Before expanding the Active Premises, Tenant must comply with applicable environmental laws and regulations to ensure public health and safety.
- (b) Tenant shall periodically test the water system within occupied buildings.

3. GROUNDS MAINTENANCE

- (a) Tenant shall provide landscape, grounds, and roadway maintenance, trash collection, and street cleaning in accordance with the following responsibilities:
 - (i) Maintain all outdoor areas of the Active Premises in a usable and safe condition.
 - (ii) Provide all landscape maintenance supplies.
 - (iii) Attend periodic maintenance walk-throughs with the Agency (Tenant maintenance contractors and subcontractors to be present) as requested and provide follow-up reports.
 - (iv) Ground Cover/Landscape: Tenant shall maintain clearance of tree limbs from power lines, street lights and other facilities. Where applicable, prune trees as needed to maintain a hazard-free branching structure.
 - (v) Tenant shall comply with all applicable federal state and local Laws and regulations in performance of the maintenance and repair work. Any maintenance and repair work shall be subject to the review and approval (which shall not be unreasonably withheld or delayed) by Agency.

4. LITTER CONTROL & TRASH COLLECTION

Tenant shall:

- (a) Control litter throughout Premises on a daily basis.
- (b) Place trash receptacles in areas and number acceptable to the Agency. Empty all trash receptacles weekly or as needed based on experience and observed need.
- (c) In the case of special events, landscape and grounds personnel will coordinate with the responsible tenant(s). Additional expenses incurred as a result of a special event may be charged to the responsible tenant.

- (d) Debris and unused materials shall be promptly removed from the Active Premises, and the area of work shall be kept reasonably clean and free of unused materials at all times. At completion of the Term of the Lease, the Active Premises shall be left without Tenant's equipment, and other undesirable materials, and in a reasonably acceptable clean and safe condition.

5. PEST CONTROL

Tenant shall be responsible for providing the necessary abatement and control against insects, weeds, fungi, rodents, etc. within the Active Premises, including, but not limited to, routine treatment of the grounds within the Active Premises, and other treatment deemed necessary by Agency. Prior to any action or application of any chemical treatment, Tenant shall coordinate any planned action with Agency and Navy.

6. ACTIVE UTILITY SERVICES

- (a) Scope of Services. In addition to the Baseline Utility Services (as herein above defined), Tenant will operate and maintain the existing and all newly constructed water distribution, sanitary and storm sewer collection systems to provide utility services to new and existing tenants located within the Premises in accordance with accepted industry standards that are protective of human health, the environment, and property and in compliance with all applicable Laws.
- (b) Systems. In addition to the Utility Baseline Services, Tenant shall provide the following Active Services to the following systems within the Active Premises:
- (i) Water System: Tenant shall operate and maintain the existing water distribution pipelines, originating from the San Francisco City Distribution System service point Jerrold Avenue/Earl Street and ending at the first valve or meter upstream of a building or facility within the Premises (the "Water Distribution Pipelines"). A comprehensive accounting of all water usage shall be kept by Tenant. Tenant shall record in a log readings from the portable device on a weekly basis and coordinate monthly reporting of this usage with the Agency for all uses on the Premises. The Parties acknowledge that one invoice for water usage and sewage disposal will be sent to the Agency by the San Francisco Public Utilities Commission ("SFPUC"). The Agency will pass through all such invoices for water usage to Tenant for immediate payment to the Agency.
- (ii) Sanitary Sewer Facilities. Until such time as Tenant disconnects sanitary sewer service on the Premises from the Navy sewer system as required by the Navy Utilities Agreement and as set forth herein, the Navy shall invoice Agency for sewer usage. The Agency will pass through to Tenant for immediate payment to the Agency all such invoices for sewage disposal services.
- (iii) Storm Water System. Tenant shall repair, operate and maintain the existing storm water collection system within the Premises from the

transition structure of surface flow entering the below surface piping (including drop inlets and other collection structures (the "Storm Water System"). The Agency, in cooperation with the City's SFPUC will advise the Regional Water Quality Control Board of the transfer of property from the Navy to the Agency in accordance with the City's SFPUC small municipal discharge permit ("MS4 permit"). Tenant understands and acknowledges that the Premises is landlocked, and Tenant shall use best management practices (BMPs) and/or more specific methods as may be required by the City's SFPUC until such time as the new storm water system is accepted by the City's SFPUC for management in accordance with the City's SFPUC MS4 permit. Tenant shall comply with all storm water management requirements set forth in the Navy Utilities Agreement, and take appropriate action to mitigate non-compliant discharges to the storm water system from sources on the Premises and maintain and repair the Storm Water System to control obstructions and surface flooding.

- (iv) Natural Gas System. Tenant shall coordinate the planning, design, and implementation of natural gas delivery services (including, without limitation thereto, the supply line owned, the main meters and pressure reducing stations at the point of delivery and the lines to individual tenants within the Active Premises.

EXHIBIT F – INSURANCE

Pursuant to and subject to the terms of Section 11.1(a) of the Interim Lease, Tenant shall procure and maintain for the duration of the Interim Lease, including any extensions, insurance against claims for injuries or death to persons or damages to property which may arise from or in connection with this Lease and the performance of any work pursuant to the on-going operations and maintenance of the Premises by Tenant, its agents, representatives, employees or subcontractors.

1. Minimum Scope of Insurance. Coverage shall be at least as broad as:

- a) Insurance Services Office Commercial General Liability coverage (occurrence form CG 0001).
- b) Insurance Services Office form number CA 00 01 covering Automobile Liability, code 1 (any auto).
- c) Workers' Compensation insurance as required by the State of California and Employers Liability insurance.
- d) Property Insurance against all risks of direct physical loss to the Active Premises.
- e) Pollution Legal Liability coverage.

2. Minimum Limits of Insurance. Tenant shall maintain limits no less than:

- a) General Liability: \$10,000,000 combined single limit per occurrence for bodily injury, personal injury and property damage. If Commercial General Liability Insurance or other form with a general aggregate limit is used, either the general aggregate limit shall apply separately to this project/location or the general aggregate limit shall be twice the required occurrence limit.
- b) Automobile Liability: \$10,000,000 combined single limit per accident for bodily injury and property damage.
- c) Workers' Compensation and Employers Liability: Workers' Compensation limits as required by the State of California and Employer's Liability limits of \$1,000,000 per accident for bodily injury or disease.
- d) Property Insurance: Full Replacement Value of the Active Premises, with no coinsurance penalty provision. In the future, it may be determined by mutual agreement of the Parties that certain buildings may be excluded from coverage. As an alternative to Tenant procuring such coverage through June 30, 2005, the Tenant may reimburse the Agency for the pro rata cost of the coverage that the Agency has in place for this period.
- e) Pollution Legal Liability: \$25,000,000 per occurrence and in the aggregate.

3. Deductibles and Self-Insured Retentions. Any deductibles or self-insured retentions must be declared to and approved by the Agency. At the option of the Agency, either the insurer shall reduce or eliminate such deductibles or self insured retention(s) as respects the Agency, the City, and their respective Commissioners, officers, agents and employees; or Tenant shall procure a bond guaranteeing payment of losses and related investigations, claim administration and defense expenses.
4. Other Insurance Provisions. The policies are to contain, or be endorsed to contain, the following provisions:
 - a) General Liability and Automobile Liability Coverages
 - i) The Agency, the City, and their respective officers, agents, employees and Commissioners are to be covered as insured as respects: liability arising out of activities performed by or on behalf of Tenant products and completed operations of Tenant, premises owned, occupied or used by Tenant or automobiles owned, leased, hired or borrowed by Tenant. The coverage shall contain no special limitations on the scope of protection afforded to the Agency, the City, and their respective Commissioners, officers, agents, or employees.
 - ii) Tenant's insurance coverage shall be primary insurance as respects the Agency, the City, and their respective Commissioners, officers, agents, and employees. Any insurance or self-insurance maintained by the Agency, the City, and their respective Commissioners, officers, agents or employees or shall be excess of Tenant's insurance and shall not contribute with it.
 - iii) Any failure to comply with reporting provisions of the policies shall not affect coverage provided to the Agency, the City, and their respective Commissioners, officers, agents or employees.
 - iv) Tenant's insurance shall apply separately to each insured against whom claim is made or suit is brought, except with respect to the limits of the insurer's liability.
 - b) Worker's Compensation and Employers Liability Coverage. The insurer shall agree to waive all rights of subrogation against the Agency, the City, and their respective Commissioners, officers, agents and employees for losses arising from work performed by or for Tenant.
 - c) All Coverages. Each insurance policy required by this clause shall be endorsed to state that coverage shall not be suspended, voided, canceled by either party, or reduced in coverage or in limits, except after thirty (30) days' prior written notice by certified mail, return receipt requested, has been given to the Agency.
 - i) Not more often than every year and upon not less than sixty (60) days prior written notice, Agency may require Tenant to increase the insurance limits set forth above if Agency finds in its reasonable judgment that it is the general commercial practice in San Francisco to carry insurance in amounts substantially

greater than those amounts carried by Tenant with respect to risks comparable to those associated with the use of the Premises.

- ii) Should Tenant's Scope of Work change pursuant to a mutually agreed upon modification of the contract and to the extent that different insurable risks are thereby created, Agency reserves the right to adjust the insurance requirement hereunder in accordance with any such changes in use.
5. Acceptability. Insurance is to be placed with insurers with a current A. M. Best's rating of no less than A:VII, unless otherwise approved by the Agency.
6. Verification of Coverage. Tenant must furnish the Agency with certificates of insurance and with original endorsements evidencing coverage required by this clause. The certificates and endorsements for each insurance policy are to be signed by a person authorized by that insurer to bind coverage on its behalf. The certificates and endorsements may be on forms provided by the Agency. All certificates and endorsement are to be received and approved by the Agency before work commences. The Agency reserves the right to require complete, certified copies of all required insurance policies, including endorsements demonstrating the coverage required by these specifications at any time.

EXHIBIT G – FENCING AND LIGHTING PLAN

1) FENCING PLAN

Tenant, at its sole cost and expense, shall provide all labor, supervision, materials, supplies, and equipment to implement a Fencing Plan for the Premises to: 1) deter unlawful entry, theft, vandalism within the Premises; 2) separate conflicting land use impacts; and 3) isolate hazardous or toxic areas for the purpose of avoiding any damages and losses of property or injuries to persons accessing the Premises.

a) SPECIFICATIONS

- i) Fencing shall be installed or repaired for portions of the Premises which abut properties outside of the Shipyard and shall be of height and materials approved by the Agency. All such fencing shall be permanently installed unless the Agency approves temporary fencing or other types of barriers for specifically identified areas.
- ii) Tenant shall comply with the Soil and Groundwater Management Plan in the installation of any fencing.
- iii) Tenant shall obtain the necessary permits from the appropriate City departments prior to the relocation and installation of fencing.

b) LOCATION

Tenant, at its sole cost and expense, shall:

- i) Repair, upgrade, install and maintain fencing around portions of the Premises which abut properties outside of the Shipyard.
- ii) Install and maintain fencing (or other types of barriers approved by the Agency) around areas within the Premises which have construction activities, hazardous materials, or other hazardous or potentially hazardous conditions, as mutually agreed upon by Tenant and Agency.
- iii) Install and maintain fencing (or other types of barriers approved by the Agency) around areas whose land use impacts conflict with adjacent land uses.
- iv) Fencing shall be located on the Premises and shall not encroach on adjacent public or private property.
- v) Consult with the appropriate fire, security, and emergency response agencies to determine the location of emergency vehicle access (EVA) routes within the Premises prior to determining fence placement.

- vi) In cooperation with Landlord, review and modify the Fencing Plan to address conditions, activities, and uses within the Premises and the adjacent properties, as the Premises expands and contracts.

c) **MAINTENANCE**

Tenant, at its sole cost and expense, shall:

- i) Repair or upgrade existing fencing within the Premises.
- ii) Conduct routine inspection of the fencing within the Premises and repair broken fencing within ten (10) business days of discovery.
- iii) Maintain fencing free of unauthorized signage, debris, trash, graffiti and weeds or overgrown grass.
- iv) Maintain gates, locks, rollers, and all other access mechanisms in good working order and ensure that access gates are operational at all times.

d) **ACCESS**

Tenant, at its sole cost and expense, shall:

- i) Provide locks for all gates and access points and maintain a key system. Tenant shall provide keys to appropriate fire, security, Agency and Navy personnel for emergency access.

2) LIGHTING PLAN

Tenant, at its sole cost and expense, shall provide all labor, supervision, materials, supplies, and equipment to implement a Lighting Plan which provides adequate lighting to: 1) deter unlawful entry, theft, vandalism within the Premises; and 2) create safe conditions in order to minimize injuries to persons accessing and traveling within the Premises.

a) **APPROVALS & SPECIFICATIONS**

Tenant shall:

- i) Consult with the Agency and all required City departments to review and approve the plans for permanent or temporary lighting.
- ii) Obtain the necessary permits from the appropriate City departments prior to the installation of permanent streetlights.
- iii) Provide to the Agency, Navy and all appropriate City departments, all associated plans, maps, plats and specifications, which identifies all wires, cables, conduits, junction boxes, and light posts, etc., necessary for the installation of streetlights.

- iv) Comply with the Soil and Groundwater Management Plan in the installation of any lighting.

b) LOCATION

Tenant, at its sole cost and expense, shall provide or cause to be provided, lighting within the Premises:

- i) Which abuts private property, where deemed necessary by the Agency and Tenant.
- ii) Along the perimeter of the Shipyard, where deemed necessary by the Agency and Tenant, to the extent that such areas are a part of the Premises.
- iii) Near the main entry points of the Shipyard (Crisp and Innes Streets).
- iv) In parking lots where deemed necessary by the Agency and Tenant.
- v) On or near occupied buildings where deemed necessary by the Agency and Tenant.
- vi) Along major arterials and thoroughfares including Crisp, Donahue, Innes Streets where deemed necessary by the Agency and Tenant.
- vii) Near public assembly buildings and areas such as restaurants, fitness facilities, exhibit spaces, museums, etc.

c) MAINTENANCE

Tenant shall:

- i) Coordinate the Lighting Plan with the existing lighting system within the Shipyard.
- ii) Coordinate with the local utility company to provide and maintain power to the streetlights.
- iii) At its sole cost and expense, repair and maintain the streetlights in working order.
- iv) Implement a re-lamping program.

EXHIBIT H – FORM OF MEMORANDUM OF LEASE